

Municipal Separate Storm Sewer System (MS4) Practices Assessment Phase III – Reclaimed Water Areas

Final Report

To

Florida Department of Environmental Protection (FDEP)

University of Florida (UF)

College of Engineering

Engineering School of Sustainable Infrastructure and

Environment (ESSIE)

Environmental Engineering Sciences (EES) Department

Gainesville, Florida 32611 USA

Acknowledgements:

The Florida Stormwater Association (FSA) is acknowledged for all their efforts in facilitating the Phase III project with FDEP as well as the recruitment and management of each of the 12 Florida participating MS4s. Each of the participating MS4s is acknowledged for all of their efforts and time, many of whom were participants in the previous Phase II project. The FDEP is acknowledged for their consideration and interest in addressing the questions that were raised from Phase II and has allowed Phase II and Phase III to be the comprehensive investigation of particulate matter and nutrient recovery by common maintenance practices in the United States to date. This project would not have been possible without the efforts, interest and common vision of the FSA, FDEP and participating MS4s.

January 2019 (revised 6 March 2019, finalized 26 April 2019)

Table of Content

Table of Content	2
List of Figures	3
List of Tables	9
EXECUTIVE SUMMARY	10
INTRODUCTION	11
BACKGROUND AND RATIONALE.....	13
MATERIALS AND METHODOLOGY	17
RESULTS	22
CONCLUSIONS.....	34
REFERENCES	35
APPENDIX.....	93

List of Figures

Figure 1 Statewide distribution of MS4 sampling locations.....	39
Figure 2 Conceptual illustration of hydrologic functional units (HFUs) sampled in this study...	40
Figure 3 Summary of the final PM sampling matrix and the corresponding PM sample numbers of total project, inside (IN) and outside (OUT) reclaimed water areas, three hydrologic functional units (HFUs) and three land uses. The original total project PM samples for 12 MS4s was n = 432.....	41
Figure 4 Summary of the final aqueous sampling matrix and the corresponding aqueous sample numbers of total project.	42
Figure 5 Example of cleaning sampling equipment	43
Figure 6 Example of collecting PM samples from street sweeping (SS).	44
Figure 7 Example of collecting PM samples from best practice management (BMP).....	45
Figure 8 Example of sample bottle label.	46
Figure 9 Example of field information document for one collected PM-sample.	47
Figure 10 Example of one MS4 (Gainesville) with selected sampling locations, land uses, and reclaimed-IN area presented.	48
Figure 11 Plot (a) and (b) summarizes the non-parametric (assumes no underlying distribution) results from Phase II MS4 PM-based data for inside reclaimed wastewater areas (IN) as compared to outside wastewater areas (OUT) for total nitrogen (TN) and total phosphorus (TP). Median values (μ_{50}) and sample size (n) of each non-parametric are reported. Comparison of the medians of IN and OUT data by the Mann-Whitney U test (MW) are also reported (see Methodology for statistical testing details). The statistical summary table below plot indicates equivalence between IN and OUT for TN and TP when a paired comparison is made for only GNV, SAC, TPH.....	49
Figure 12 Cumulative distribution function (CDF) of Phase III MS4 data from reclaimed IN and OUT area for total nitrogen and phosphorus. Median values (μ_{50}) are reported. Kolmogorov–Smirnov test ($p > 0.05$) indicates data fit log-logistic distribution with parameters α and β within 95% confidence intervals. Parameters α is a model index for the model median (central tendency) and β is a model index for the model scale (range of concentrations). The symbols represent histogram equivalents of the measured data. Comparison of the medians of IN and OUT data by Mann-Whitney U test (MW) are also reported (see Methodology for statistical testing details).	50
Figure 13 Cumulative distribution function (CDF) of all lumped MS4 data (IN and OUT) for total, organic and leached nitrogen. Median values (μ_{50}) are reported. Kolmogorov–Smirnov test ($p > 0.05$) indicates data fit log-logistic distribution with parameters α and β within 95% confidence intervals. Parameters α is a model index for the model median (central tendency) and β is a model index for the model scale (range of concentrations). The symbols represent histogram equivalents of the measured data. The box plot summarizes the median, upper and	

lower quartiles for the leached fraction which is the ratio of leached nitrogen (NO_x and NH_4^+) to TN. Small differences in sample number (n) are due to selected samples provided without sufficient mass. 51

Figure 14 Cumulative distribution function (CDF) of all lumped MS4 data (IN and OUT) by street sweeping (SS) for total, organic and leached nitrogen. Median values (μ_{50}) are reported. Kolmogorov–Smirnov test ($p > 0.05$) indicates data fit log-logistic distribution with parameters α and β within 95% confidence intervals. Parameters α is a model index for the model median (central tendency) and β is a model index for the model scale (range of concentrations). The symbols represent histogram equivalents of the measured data. Box plot summarized the median, upper and lower quartiles for leached fraction which is the ratio of leached nitrogen (NO_x and NH_4^+) to TN. Small differences in sample number (n) are due to selected samples provided without sufficient mass. 52

Figure 15 Cumulative distribution function (CDF) of all lumped MS4 data (IN and OUT) by catch basin (CB) for total, organic and leached nitrogen. Median values (μ_{50}) are reported. Kolmogorov–Smirnov test ($p > 0.05$) indicates data fit log-logistic distribution with parameters α and β within 95% confidence intervals. Parameters α is a model index for the model median (central tendency) and β is a model index for the model scale (range of concentrations). The symbols represent histogram equivalents of the measured data. Box plot summarized the median, upper and lower quartiles for leached fraction which is the ratio of leached nitrogen (NO_x and NH_4^+) to TN. Small differences in sample number (n) are due to selected samples provided without sufficient mass. 53

Figure 16 Cumulative distribution function (CDF) of all lumped MS4 data (IN and OUT) by best management practice (BMP) for total, organic and leached nitrogen. Median values (μ_{50}) are reported. Kolmogorov–Smirnov test ($p > 0.05$) indicates data fit log-logistic distribution with parameters α and β within 95% confidence intervals. Parameters α is a model index for the model median (central tendency) and β is a model index for the model scale (range of concentrations). The symbols represent histogram equivalents of the measured data. Box plot summarized the median, upper and lower quartiles for leached fraction which is the ratio of leached nitrogen (NO_x and NH_4^+) to TN. Small differences in sample number (n) are due to selected samples provided without sufficient mass. 54

Figure 17 Cumulative distribution function (CDF) of all lumped MS4 data (IN and OUT) by residential land use for total, organic and leached nitrogen. Median values (μ_{50}) are reported. Kolmogorov–Smirnov test ($p > 0.05$) indicates data fit log-logistic distribution with parameters α and β within 95% confidence intervals. Parameters α is a model index for the model median (central tendency) and β is a model index for the model scale (range of concentrations). The symbols represent histogram equivalents of the measured data. Box plot summarized the median, upper and lower quartiles for leached fraction which is the ratio of leached nitrogen (NO_x and NH_4^+) to TN. Small differences in sample number (n) are due to selected samples provided without sufficient mass. 55

Figure 18 Cumulative distribution function (CDF) of all lumped MS4 data (IN and OUT) by highway land use for total, organic and leached nitrogen. Median values (μ_{50}) are reported.

Kolmogorov–Smirnov test ($p > 0.05$) indicates data fit log-logistic distribution with parameters α and β within 95% confidence intervals. Parameters α is a model index for the model median (central tendency) and β is a model index for the model scale (range of concentrations). The symbols represent histogram equivalents of the measured data. Box plot summarized the median, upper and lower quartiles for leached fraction which is the ratio of leached nitrogen (NO_x and NH_4^+) to TN. Small differences in sample number (n) are due to selected samples provided without sufficient mass. 56

Figure 19 Cumulative distribution function (CDF) of all lumped MS4 data (IN and OUT) by commercial land use for total, organic and leached nitrogen. Median values (μ_{50}) are reported. Kolmogorov–Smirnov test ($p > 0.05$) indicates data fit log-logistic distribution with parameters α and β within 95% confidence intervals. Parameters α is a model index for the model median (central tendency) and β is a model index for the model scale (range of concentrations). The symbols represent histogram equivalents of the measured data. Box plot summarized the median, upper and lower quartiles for leached fraction which is the ratio of leached nitrogen (NO_x and NH_4^+) to TN. Small differences in sample number (n) are due to selected samples provided without sufficient mass. 57

Figure 20 Non-parametric (assumes no underlying distribution) plots of all lumped MS4 data (IN and OUT) by hydrologic function units (HFUs) and land uses for total and organic nitrogen. Median and sample size (n) and of each plot are reported. Comparison of the medians of two groups by Mann-Whitney U test (MW) are also reported (see statistical analysis for details). ... 58

Figure 21 Box plots of all lumped MS4 data (IN and OUT) by hydrologic function units (HFUs) and land uses for leached nitrogen (NO_x and NH_4^+). Median and sample size (n) and of each plot are reported. Comparison of the medians of two groups by Mann-Whitney U test (MW) are also reported. 59

Figure 22 Cumulative distribution function (CDF) of all lumped MS4 data (IN and OUT) for total and leached phosphorus. Median values (μ_{50}) are reported. Kolmogorov–Smirnov test ($p > 0.05$) indicates data fit log-logistic distribution with parameters α and β within 95% confidence intervals. Parameters α is a model index for the model median (central tendency) and β is a model index for the model scale (range of concentrations). The symbols represent histogram equivalents of the measured data. Box plot summarized the median, upper and lower quartiles for leached fraction which is the ratio of leached phosphorus to TP. Small differences in sample number (n) are due to selected samples provided without sufficient mass..... 60

Figure 23 Cumulative distribution function (CDF) of all lumped MS4 data by hydrologic function units for total and leached phosphorus. Median values (μ_{50}) are reported. Kolmogorov–Smirnov test ($p > 0.05$) indicates data fit log-logistic distribution with parameters α and β within 95% confidence intervals. Parameters α is a model index for the model median (central tendency) and β is a model index for the model scale (range of concentrations). The symbols represent histogram equivalents of the measured data. Box plot summarized the median, upper and lower quartiles for leached fraction which is the ratio of leached phosphorus to TP. Small differences in sample number (n) are due to selected samples provided without sufficient mass. 61

Figure 24 Cumulative distribution function (CDF) of all lumped MS4 data (IN and OUT) by land uses for total and leached phosphorus. Median values (μ_{50}) are reported. Kolmogorov–Smirnov test ($p > 0.05$) indicates data fit log-logistic distribution with parameters α and β within 95% confidence intervals. Parameters α is a model index for the model median (central tendency) and β is a model index for the model scale (range of concentrations). The symbols represent histogram equivalents of the measured data. Box plot summarized the median, upper and lower quartiles for leached fraction which is the ratio of leached phosphorus to TP. Small differences in sample number (n) are due to selected samples provided without sufficient mass. 62

Figure 25 Box plots of all lumped MS4 data (IN and OUT) by hydrologic function units (HFUs) and land uses for total and leached phosphorus. Median and sample size (n) and of each plot are reported. Comparison of the medians of two groups by Mann-Whitney U test (MW) are also reported. 63

Figure 26 Box plots of all lumped and then separated MS4 data from reclaimed IN and OUT area for total nitrogen (TN) across total and each PM fraction. Biogenic matter is selected from PM with diameters greater than 2000 μm . For all results, sediment is a PM fraction with diameters between 75 and 2000 μm (by definition and separated before the Imhoff Cone procedure). Settleable is PM with diameters between 25 and 75 μm . Suspended is PM with diameters under 25 μm . For all results reported as operational PM size classes or fractions, settleable and suspended PM are operational separated at one hour of quiescent settling in an Imhoff Cone. Median and sample size (n) and of each plot are reported. 64

Figure 27 Box plots of all lumped MS4 data (IN and OUT) by hydrologic functional units (HFUs) for total nitrogen (TN) across total and each PM fraction. Biogenic matter is selected from PM with diameters greater than 2000 μm . Sediment is PM with diameters between 75 and 2000 μm . Settleable is PM with diameters between 25 and 75 μm . Suspended is PM with diameters under 25 μm . Median and sample size (n) and of each plot are reported. 65

Figure 28 Box plots of all lumped MS4 data (IN and OUT) by land uses for total nitrogen (TN) across total and each PM fraction. Biogenic matter is selected from PM with diameters greater than 2000 μm . Sediment is PM with diameters between 75 and 2000 μm . Settleable PM with diameter between 25 and 75 μm . Suspended is PM with diameters under 25 μm . Median and sample size (n) and of each plot are reported. 66

Figure 29 Box plots of all lumped and then separated MS4 data from reclaimed IN and OUT area for total phosphorus (TP) across total and each PM fraction. Biogenic matter is selected from PM with diameters greater than 2000 μm . Sediment is PM with diameters between 75 and 2000 μm . Settleable is PM with diameters between 25 and 75 μm . Suspended is PM with diameters under 25 μm . Median and sample size (n) and of each plot are reported. 67

Figure 30 Box plots of all lumped MS4 data (IN and OUT) by hydrologic functional units (HFUs) for total phosphorus (TP) across total and each PM fraction. Biogenic matter is selected from PM with diameters greater than 2000 μm . Sediment is PM with diameters between 75 and 2000 μm . Settleable is PM with diameters between 25 and 75 μm . Suspended is PM with diameters under 25 μm . Median and sample size (n) and of each plot are reported. 68

Figure 31 Box plots of all lumped MS4 data (IN and OUT) by land uses for total phosphorus (TP) across total and each PM fraction. Biogenic matter is selected from PM with diameters greater than 2000 μm . Sediment is PM with diameters between 75 and 2000 μm . Settleable is PM with diameters between 25 and 75 μm . Suspended is PM with diameters under 25 μm . Median and sample size (n) and of each plot are reported. 69

Figure 32 Box plots of all lumped and then separated MS4 data from reclaimed IN and OUT area for volatile fraction (VF) across total and each PM fraction. Biogenic matter is selected from PM with diameters greater than 2000 μm . Sediment is PM with diameters between 75 and 2000 μm . Settleable is PM with diameters between 25 and 75 μm . Suspended is PM with diameters under 25 μm . Median and sample size (n) and of each plot are reported. 70

Figure 33 Box plots of all lumped MS4 data (IN and OUT) by hydrologic functional units (HFUs) for volatile fraction (VF) across total and each PM fraction. Biogenic matter is selected from PM with diameter greater than 2000 μm . Sediment is PM with diameter between 75 and 2000 μm . Settleable is PM with diameters between 25 and 75 μm . Suspended is PM with diameters under 25 μm . Median and sample size (n) and of each plot are reported. 71

Figure 34 Box plots of all lumped MS4 data (IN and OUT) by land uses for volatile fraction (VF) across total and each PM fraction. Biogenic matter is selected from PM with diameters greater than 2000 μm . Sediment is PM with diameters between 75 and 2000 μm . Settleable is PM with diameters between 25 and 75 μm . Suspended is PM with diameters under 25 μm . Median and sample size (n) and of each plot are reported. 72

Figure 35 Probability density distribution (PDF) of all lumped and then separated MS4 data from reclaimed IN and OUT area for water content (WC). Median values (μ_{50}) are reported. Kolmogorov–Smirnov test ($p > 0.05$) indicates data fit log-logistic distribution with parameters α and β within 95% confidence intervals. Parameters α is a model index for the model median (central tendency) and β is a model index for the model scale (range of concentrations). The symbols represent histogram equivalents of the measured data. Comparison of the medians of IN and OUT data by Mann-Whitney U (MW) test are also reported (see statistical analysis for details)..... 73

Figure 36 Probability density distribution (PDF) of all lumped MS4 data (IN and OUT) by hydrologic functional units (HFUs) for water content (WC). Median values (μ_{50}) are reported. Kolmogorov–Smirnov test ($p > 0.05$) indicates data fit log-logistic distribution with parameters α and β within 95% confidence intervals. Parameters α is a model index for the model median (central tendency) and β is a model index for the model scale (range of concentrations). The symbols represent histogram equivalents of the measured data. 74

Figure 37 Probability density distribution (PDF) of all lumped MS4 data (IN and OUT) by land uses for water content (WC). Median values (μ_{50}) are reported. Kolmogorov–Smirnov test ($p > 0.05$) indicates data fit log-logistic distribution with parameters α and β within 95% confidence intervals. Parameters α is a model index for the model median (central tendency) and β is a model index for the model scale (range of concentrations). The symbols represent histogram equivalents of the measured data. 75

Figure 38 Box plots of all lumped and then separated MS4 data from reclaimed IN and OUT area for total and fractional water content (WC) across PM fractions that are coarser and finer than 2000 μm . Median and sample size (n) and of each plot are reported. 76

Figure 39 Box plots of all lumped MS4 data (IN and OUT) by hydrologic functional units (HFUs) for total and fractional water content (WC) across PM fractions that are coarser and finer than 2000 μm . Median and sample size (n) and of each plot are reported. 77

Figure 40 Box plots of all lumped MS4 data (IN and OUT) by land uses for total and fractional water content (WC) across PM fractions that are coarser and finer than 2000 μm . Median and sample size (n) and of each plot are reported. 78

Figure 41 Correlation between previous dry hour (PDH) and water content of samples collected by street sweeping (SS) from inside (IN) or outside (OUT) reclaimed area. Linear regression is reported with 95% confidence interval (C.I.). 79

Figure 42 Box plots of all MS4 water samples for total nitrogen (TN) and total dissolved nitrogen (TDN) by WWTP effluent and distribution nozzle discharges inside reclaimed water area, control runoff samples (t = 0, 5, 10, 15 minutes) outside reclaimed water area. Time 0 represents the beginning of runoff. Median and sample size (n) and of each plot are reported. .. 80

Figure 43 Box plots of all MS4 water samples for total phosphorus (TP) and total dissolved phosphorus (TDP) by WWTP effluent and distribution nozzle discharges inside reclaimed water area, control runoff samples (t = 0, 5, 10, 15 minutes) outside reclaimed water area. Time 0 represents the beginning of runoff. Median and sample size (n) and of each plot are reported. .. 81

Figure 44 Example of unit area in GNV 82

Figure 45 Non-parametric box plots of all lumped data (IN and OUT) by individual MS4 for total nitrogen (TN) and total phosphorus (TP). Median and sample size (n) of each plot are reported. 93

Figure 46 Plot (a) and (c) indicates statistical equivalence of the median TN whether comparing Phase II and III with their entire data from inside reclaimed wastewater areas (IN) and outside wastewater areas (OUT), or data only from OUT. Plot (b) and (d) indicates the median TP of Phase II is statistically greater than Phase III with data whether from IN and OUT area or only from OUT area. Comparison of the medians of IN and OUT data by the Mann-Whitney U test (MW) are also reported (see Methodology for statistical testing details)..... 94

List of Tables

Table 1 Summary of applicable laboratory analyses for particulate and biogenic samples.	83
Table 2 Summary of applicable laboratory analyses for aqueous samples.	84
Table 3 This table represents the Florida-based metrics developed in this study to convert dry PM mass to a PM-based TP or TN in units of [mg/TP or TN per dry mass in kg of PM recovered] when considering water content (WC) as %. The metrics are presented as a function of HFU from PM recovered by street sweeping (SS), catch basin (CB) cleaning, and BMP maintenance. IN+OUT in the table represents the 50 th percentile values for each HFU considering IN and OUT of reclaimed wastewater areas. The metrics are quantified as medians (50 th percentile) and are used to illustrate a concise summary of the results in this report.	85
Table 4 Florida-based PM total phosphorus (TP) concentration 25 th , median, and 75 th percentile values as a function of each HFU and land use.	86
Table 5 Florida-based PM total nitrogen (TN) concentration 25 th , median, and 75 th percentile values as a function of each HFU and land use.	87
Table 6 Florida-based PM water content (WC) 25 th , median, and 75 th percentile values as a function of each HFU and land use.....	88
Table 7 Florida-based PM total phosphorus (TP) and total nitrogen (TN) concentration 25 th , median and 75 th percentile values for each HFU independent of land use.....	89
Table 8 PM mass fraction (%) as 4 PM operational size gradations (fractions) for all MS4s and each MS4 by total and 3 land uses (R, H, C), 3 hydrologic functional units (BMP, CB, SS).....	90
Table 9. Calculation of total nitrogen (TN) and total phosphorus (TP) as areal-weighting value for only residential (R) land use in unit area.....	91
Table 10 Result and calculation of total nitrogen (TN) and total phosphorus (TP) as areal-weighting value for whole unit area. Area of residential (R), highway (H), and commercial (C) are also reported.....	92

EXECUTIVE SUMMARY

The Phase III project (2016 to 2018) was developed from the success of the Phase II project (Berretta et al. 2011) implementation across 14 Florida MS4, many of whom participated in Phase III. However in contrast to the Phase II project, the primary objective of the Phase III project is an examination of particulate matter (PM), PM-based TN and TP from 12 MS4s across Florida with paired sampling from inside (IN) and outside (OUT) wastewater reclaimed areas. In addition, aqueous-based sampling compared MS4 wastewater treatment plant (WWTP) effluent, reclaimed wastewater discharge from the distribution system from IN areas, and runoff from OUT areas as an aqueous-based control. Land use categories were residential, commercial and highway and hydrologic functional units (HFUs) were street sweeping (SS), catch basins (CBs) and best management practices (BMPs) for Phase II and III. Since all resulting load credits are based on dry PM, both projects examined water content (WC) of recovered PM; required for accurate accounting of dry PM recovered. Accurate WC is mandatory for TN and TP load credits. A WC nomograph, leaching of PM-based TN and TP, the mass-based distribution of PM size fractions, and an updated interactive spreadsheet are provided based on Phase III results.

While there was a significant level of analyses and results, the Florida-based implementable results are embodied concisely in Table 3 and applied in the updated interactive spreadsheet. Phase III results are statistically defensible at a 95% confidence level (CL) combining all 12 MS4s for PM, TN and TP. As results are parsed to specific MS4s with lower statistical power, conclusions vary by MS4 and cannot consistently be defended at a 95% CL. Comparisons are based on the representative statistic (median, 50th percentile) of the distributions. On a Florida-basis, at a 95% confidence level, PM-based TN and TP [mg/kg] are not statistically significantly different between IN and OUT. As a result, Phase III results were combined for IN and OUT (Table 3 to 8), although summary results (Table 3) provide IN, OUT and IN + OUT statistics. Comparing Phase II TN (OUT only project) there was statistical equivalence to Phase III; for TP, Phase II was statistically higher than III. Phase II modeled PM-based distributions as lognormal; in Phase III distributions were log-logistic, a similar distribution and physical interpretation. Median leached fractions of PM-based TN did not exceed 2% largely as organic nitrogen (N_{org}), and was $\approx 10\%$ for TP; predominately as orthophosphates. For HFUs, BMPs produced the highest TP leaching from lack of maintenance, long storage residence times and water chemistry non-stationarity between runoff events or maintenance. For a Florida-basis there is a statistically significant increase in PM WC for IN compared to OUT; consistent with irrigation run-on to pavement. Table 3 reports WC medians. As with Phase II, SS had the lowest and BMPs the highest WC. By definition and by analyses, nutrient concentrations [mg/kg] increase from sediment ($> 75 \mu\text{m}$) (most labile in BMPs but potentially separable) to suspended (most bio-available, not effectively separated by BMPs), while on a total mass basis, PM and nutrients are dominated by sediment. Sediment PM dominates urban PSDs and maintenance thereof. PM is the dominant substrate to accumulate nutrient loads inside/outside BMPs, not engineered media utilized in Florida BMPs. As with Phase II, SS is the most economical and dominant practice that MS4s can implement and optimize to maximize nutrient and PM recovery benefits to urban drainage systems and the environment. Maintenance and recovery of PM matters!

INTRODUCTION

While N (nitrogen) can be a limiting nutrient for terrestrial and vascular plants (Vitousek and Howarth 1991), N and P (phosphorus) impact eutrophication and environmental conditions such as red-tide. Eutrophication driven by N and P, from well-defined point and highly variable, unsteady non-point (diffuse) discharges, can lead to environments that are no longer limiting for native vegetated communities. For example, inputs of N from fertilizer to urban landscaped areas, biogenic loadings in run-on from these areas to impervious surfaces in urban environs in conjunction with altered and unsteady rainfall-runoff responses from these impervious urban systems are driving eutrophication in terrestrial and aquatic ecosystems (Vitousek et al. 1997). These sources of N in runoff also include nitrates in rainfall, while both N and P sources include leaf fall, landscape maintenance byproducts such as grass clippings, soil or anthropogenic particulate matter (PM) which can be transported by runoff and/or reclaimed wastewater reuse through irrigation. Runoff, run-on and irrigation over-spray is effectively conveyed by design across largely impervious urban surfaces as a function of flow rate during a storm or irrigation over-spray. Entrained in this flow is PM that is either transported or re-deposited as a function of the PM granulometry; primarily as a function of particle size distribution (PSD) and PM specific gravity as well as hydraulic stress on the urban surface. In the urban conveyance process, whether from source areas or conveyance systems such as curb and gutter, catch basins (CB), best management practices (BMPs) or pipes, swales or ditches, N and P *partition to and from PM* with PM serving as the primary vehicle of nutrient transport, partitioning and distribution.

Urban land uses, cover conditions, design and construction practices, primarily the use of impervious pavement have significantly altered the relationship between rainfall and runoff as well as local climate parameters. Furthermore, alteration of runoff response parameters by impervious surfaces leads to increased peak flow, volume of flow and hydraulic stresses as well as reduced runoff response time that drives nutrient and chemical interactions with PM and transport to receiving waters. N and P loadings above threshold or native background values result in algal and nuisance plant blooms, fish mortality as a result of hypoxia, altered water chemistry, increased health risks from water supplies and loss of biodiversity/habitat. An impact of eutrophication and PM delivery is oxygen depletion (anaerobic conditions) in unmaintained stormwater appurtenances such as catch basins, unmaintained BMPs such as wet vaults or hydrodynamic separators, or BMPs with wet sumps and ultimately in receiving waters. Such impairments impact aesthetics, ecology and water use designations. A current example around coastal Florida of these impacts are toxic algal blooms and red tide. For decades documentation has identified excess N and P loadings as the leading cause of impairment in the USA (Carpenter et al. 1998; USEPA 1993, USEPA 2010). Eutrophication has been identified with over 50% of impaired lakes and over 60% of impaired rivers in the USA (USEPA 1996).

Previous research has documented nutrient levels in runoff. A nationwide study by Pitt et al. (2004) reported a median total nitrogen (TN) of 2.0 mg/L for runoff based on a dataset of 3770 individual events. In Florida, where this study is conducted, almost two decades ago USEPA established a recommended TN criterion of 0.52 mg/L for runoff into lakes and

reservoirs and 0.36 mg/L into rivers and streams (USEPA 2000a, b). Criteria were based on the 25th percentile of a pool of randomly-selected sites in the eco-regions. In the last decade promulgated numeric nutrient criteria (NNC), for example, TN was set as 1.27 mg/L for colored lakes and 1.87 mg/L for streams in North Central Florida (USEPA 2010). More granular values of TN and total phosphorus (TP) are a function of the six Florida watershed regions, their receiving water chemistry (for example, alkalinity) and indices (such as color) and the values will likely remain in a state of flux in the coming decade. Irrespective of current and future NNC for TN and TP, the goal of significant reductions in nutrient loads, most recently driven by impacts of toxic algal blooms and red tide, will continue to remain a significant priority in Florida.

In runoff, based on a two-phase model of partitioning, TN and TP partition nominally into dissolved and particulate (PM) phases. TN partitioning depends on adsorption-desorption phenomena, microbial activity, leaching from biogenic materials, hydrodynamics and, residence time in flow, and water chemistry parameters including the concentration and distribution of TN and TP as well as PM granulometry. The dissolved fraction of TN is quite variable, from 20 to 80% of TN (Vaze and Chiew 2004; Hvitved-Jacobsen and Yousef 1991; Hvitved-Jacobsen et al. 1994; Taylor et al 2005; Shinya et al. 2003) with higher PM-based fractions (50 to 60%) associated with urban source area runoff to CBs and BMPs (Zhang and Sansalone 2014). Knowledge of PM-based concentrations [mg/g, mg/kg] of N and P as a function of PM size fractions (suspended, settleable and sediment) or across the PSD allows for the prediction of PM-based fate for physical PM separation such as clarification, for example sedimentation or filtration. PM is a major source of N and a study by Vaze and Chiew (2004) characterized PN as a function of PM fractions. The Vaze and Chiew study was based on a paved source area in Melbourne, Australia and reported that less than 15% of TN (by mass) was bound to PM with particle diameters greater than 300 μm , while approximately 50% of the PM mass was coarser than 300 μm . Their results also indicated that dissolved N (DN) ranged from 20 to 50% of the TN in stormwater and that most N was associated with PM between 11 and 150 μm . The speciation, partitioning and distribution of P are relatively stable as compared to N. N can be biologically-mediated under anoxic/anaerobic redox conditions in BMPs and returned to the water column as dissolved species of N, primarily nitrate and ammonia species. Approximately one-third of P in source area runoff is dissolved and PM-based P represents two-thirds of TP and PM-based concentrations typically ranges from 0.01 to 10 mg/g with the highest values for suspended and lowest for coarser sediment PM, noting that the predominance of the runoff PM mass is sediment-size or coarser (Ma et al. 2010, Sansalone and Ma 2011). As a definition, PM-based concentration is the ratio of a PM-based chemical mass to the dry PM mass. For urban PM that is not predominately biogenic (organic), the highest PM-based values [mg of nutrient/g of dry PM] are associated with the suspended PM (< 25 μm) which is of lower overall total mass (g) and total surface area (m^2) with respect to the PSD but has the highest specific surface area (SSA) in m^2/g ; excepting the biogenic PM fraction (Berretta and Sansalone 2011a, b). Transport of N in runoff is influenced by rainfall duration, intensity, antecedent dry weather periods, land use, season, vegetation, average daily traffic (ADT), atmospheric deposition, watershed area and surface, slope, PM granulometry and soil parameters (Pitt et al. 2004; Huber et al. 2008).

Results of these studies have provided knowledge of specific N indices. Building on these results, this study includes nutrient “first-flush” transport, distribution and partitioning.

While low impact development practices (LID) at the parcel or catchment-level often are increasingly used for urban land uses (Sample et al. 2006) providing hydrologic restoration and therefore load reduction, structural unit operations (commonly identified as BMPs) such as wet and dry basins, vaults, or manufactured systems such as hydrodynamic separators continue to be most commonly applied. Without frequent maintenance viable performance of nearly all small footprint BMPs for nutrient reduction is not sustainable. Even with frequent maintenance for many of these unit operations, the control of dissolved and suspended N and P has been much less effective compared to separation of coarser sediment-size PM-bound N and P through sedimentation mechanisms and physical filtration (Jenkins et al., 1971, Liu et al. 2010, Sansalone et al. 2010). During inter-event storage of PM, gross solids, nutrients, chemicals and runoff in stormwater appurtenances and BMPs, coupled redox and pH changes occur. One of the major concerns with small footprint BMPs such as vaults, tanks and screened hydrodynamic separators is scour of PM and associated nutrients as well as washout of nutrients or chemicals such as metals that have re-partitioned back to the water column in the BMP. Maintenance not only has the potential to provide load credits but irrespective of load credits will result in the intended and extended unit operation (BMP) behavior.

BACKGROUND AND RATIONALE

Wastewater and stormwater reclamation for beneficial uses is an established and growing practice across Florida’s municipalities; providing a more sustainable alternative to increasing potable water usage. Urban/suburban irrigation represents a significant water resources demand that is increasingly achieved, primarily with reclaimed wastewater. This reclaimed water is harvested primarily from advanced wastewater treatment (AWT) systems, from secondary wastewater treatment plants (WWTP) and to a much lower extent from stormwater systems that supply reclaimed water for beneficial uses.

As a part of the MS4 Practices Assessment Study through the Florida Stormwater Association Educational Foundation (FSAEF or Phase II Study) by the University of Florida (Berretta, *et al* 2011), TP and TN concentrations/loads for particulate matter (PM) recovered during typical MS4 maintenance operations of street sweeping (SS), catch basin (CB) cleaning and best management practice (BMP) cleaning were examined for 14 MS4s without reclaimed wastewater irrigation. While not part of the scope of this Phase II study, the investigators decided to explore the potential of TN and TP enrichment of urban PM in reclaimed wastewater areas through the practice of irrigation to roadway medians and also landscaped areas that can provide run-on to pavement.

The FSAEF 2011 (Phase II) study objective developed singular Florida-based metrics (mg of TP or TN/kg of PM) for land uses outside of reclaimed wastewater areas for 14 MS4s across Florida. These metrics permitted direct translation of common PM load recovery to TP and TN recovery and credits in a BMAP process.

An un-proposed objective of the previous FSAEF study was to explore and compare TP and TN metrics from three MS4s for PM (irrespective of PM size gradation classes) recovered by maintenance operations from outside and inside wastewater reclaimed areas. In this small subset, results indicated potential TP enrichment of PM was quantitatively and statistically higher in wastewater reclaimed areas across land uses examined for BMPs in Gainesville, Tampa and Sarasota.

The FSAEF study produced a singular Florida-based load credit metric for TP and TN that is now widely utilized by Florida MS4s. The study has also served as a template for other states. Yet, the study also identified nutrient and load metrics/tools that can further improve the breadth, depth and utility of the foundational FSAEF study. This led to a series of proposed objectives for the current Phase III study:

- (1) the reclaimed water enrichment of recovered PM, the primary project objective,*
- (2) the enrichment of specific PM size classes,*
- (3) the leaching of PM by stormwater,*
- (4) a PM water content nomograph,*
- (5) a 2nd generation interactive spreadsheet.*

Following the order of the proposed objectives the background of each objective is further described along with the respective supporting rationale.

(1) The reclaimed water enrichment of PM recovered from maintenance operations:

For over the last decade, reclaimed water has become an important volumetric component of the water cycle for many of Florida's MS4s. In comparison to the FSAEF 2011 study focused on load credits generated from results largely outside of reclaimed water areas; this proposed study is more focused on quantifying nutrient distribution, leaching and recovery from reclaimed wastewater areas in order for MS4s to develop the credit methodology for maintenance operations in reclaimed wastewater areas around Florida. In this Phase III study, the "control" areas are the areas outside the reclaimed areas of the same land use. The Phase III study characterized TP and TN of reclaimed water sources whether from AWT or secondary WWTP providing guidance for loading potentials from reclaimed water to the MS4 environments. This required final effluent (a source) and stormwater (control from a source area outside of reclaimed areas) sampling, commensurate nutrient and PM analysis.

In the current Phase III study, the land uses (residential, commercial, highway) and the hydrological functional units (HFU) of SS, CB and BMPs remained the same as the Phase II study. The Phase III study design was based on working through as many original project MS4s as possible; and at least 12 MS4s, for the three land uses and for the street sweeping (SS), CB and BMPs hydrologic functional units (HFU) therein. Results from these MS4s will be based on paired inside/outside reclaimed water areas for the land uses and HFUs. The existing and very extensive database and QAPP from the previous FSAEF 2011 study was used as a basis and guidance for the Phase III study.

For over the last decade, reclaimed water has become an important volumetric component of the water cycle for many of Florida's MS4s. In comparison to the FSAEF 2011 study focused on load credits generated from results largely outside of reclaimed water areas; this proposed study is more focused on quantifying nutrient distribution, leaching and recovery from reclaimed wastewater areas in order for MS4s to develop the credit methodology for maintenance operations in reclaimed wastewater areas around Florida. In this Phase III study, the "control" areas are the areas outside the reclaimed areas of the same land use and are only loaded by stormwater, not reclaimed water. The Phase III study characterized TP and TN of reclaimed water sources (AWT or secondary WWTP as well as reclaimed water distribution nozzles) providing guidance for loading potentials from reclaimed water to the MS4 environments. Characterization required sampling of final effluent from AWT or secondary WWTPs, a reclaimed water discharge from in the distribution system for IN areas, and stormwater (control) in OUT areas; with commensurate nutrient and PM analysis.

(2) The nutrient enrichment of specific PM size classes:

Urban PM, which includes biogenic material and urban detritus, is a primary source and sink of nutrients; metals, endocrine disruptors and other chemical compounds notwithstanding. PM represents the primary reservoir that functions to detain nutrients and chemical compounds from receiving waters. TP is preferentially partitioned or sorbed by PM resulting in a dissolved fraction of 25 to 35% of TP in stormwater. In contrast, TN is preferentially leached from biogenic PM and urban detritus and the TN partitioning to the stormwater aqueous fraction increases as a function of time to a dissolved fraction that is greater than 50%. The application of reclaimed water alters the partitioning between PM, as a reservoir for TP and TN, and the stormwater aqueous fraction. This altered behavior is unknown. The granulometric characteristics of PM impact the capacity of PM to function as an increased source or sink (as in the case of TP) for nutrients. Therefore, in addition to delivery of TP and TN concentrations in reclaimed effluent that are transported to a HFU, the granulometric characteristics of the PM recovered from the HFU provide quantitative indices that represent the level to which PM can function as a source or sink of nutrients. Depending on PM size and density (as indexed by the volatile fraction), PM in the sand-size with inorganic densities (low volatile fractions) up to approximately 2 mm can be transported through HFUs, with the coarser fraction largely settled and detained in HFUs. In contrast the finer silt and clay-size fraction of PM remain as the mobile PM that is largely transported through HFUs including

BMPs; without significant detention as these fractions are transported towards receiving waters in stormwater events. While coarser fractions of PM are less mobile and accrete in HFUs, and this coarser PM constitutes the predominance of available total surface area that serves as a source or sink, this PM is also the most leachable. In contrast the finer fractions of PM are highly mobile even through BMPs, more reactive, have lower total surface area that serves as a source or sink as compared to the coarse fraction, yet are less leachable. Therefore HFUs are temporary reservoirs of PM fractions and can serve as a source/sink for nutrients depending on the granulometry of PM and management of the HFU.

The distribution of TP and TN for PM fractions is needed because different HFUs capture different fractions of PM. Furthermore, HFUs, in particular BMPs have varying degrees of efficacy depending on design and maintenance and therefore capture or elute different PM size fractions when comparing BMPs. SS does not recover the same PM size fractions and this recovery is in part dependent on equipment, operation and frequency as well as the parent PSD. Beyond a focus on reclaimed water areas in this proposed study, the focus on PM size classes is also unique from the FSAEF 2011 study. Additionally, for example as a Florida-based reclaimed water metric from the analysis of nutrients of PM fractions, will allow the synthesis of TP/TN load recovery from the total PSDs that is comprised of the individual size fractions. PM size fractions (and the associated nutrient loads) are unique delimiters and the building block for any PSD. The PSD is simply a site-, a location-, a condition- or operation-specific synthesis of PM size fractions and their respective nutrient loads. The proposed size classes are pragmatically kept to three, requiring only two standard size separations and these size classes have physical, standards and regulatory foundations.

(3) The leaching of PM by stormwater:

Urban PM, exposed to rainfall and/or runoff potentially leaches constituents (nutrients, metals, organics ...), in part, depending on PM granulometry, residence time of PM in contact with rainfall/runoff, water chemistry and concentration gradients between PM and the aqueous matrix. For example, in urban runoff, a primary source of total dissolved solids (TDS) and alkalinity is leaching from (not to) PM. Leaching of TP and TN is more complex; where PM can function both as a source (leaching) and sink (sorber) of nutrients. The addition of reclaimed water to the urban surface will alter the extent to which PM functions as a source or sink of TP and TN. Reclaimed water is also an added source of total organic carbon (TOC) source for an urban environment that delivers PM that is largely inorganic, biogenic loads notwithstanding. Therefore in a BMP or catch basin with wet sumps that detain PM between maintenance cycles and are subject to reclaimed water, represent a nutrient-rich (TN, TP, TOC) habitat for microbial growth and nutrient conversions/fate. Such conditions between maintenance cycles will result in significantly altered conditions for leaching as compared to dry PM or even wet PM subject to aerobic conditions. Furthermore, cyclic oxidation-reduction conditions between runoff events and/or maintenance cycles further alter the leaching of nutrients. The knowledge of the leaching extent and rate are important guidance tools to optimize detention and recovery of PM as well as nutrients before these constituents are impacted by resuspension/elution and by leaching. Leaching

and/or sorption rates, from or to PM, will be collected and analyzed for GNV locations only because of what are potentially (but as of yet unknown) time-based and aerobic/anaerobic dependencies. Results can provide guidance for balancing HFUs as either a temporary reservoir for a MS4 or as a temporal source of nutrients transported through a MS4.

(4) A PM water content nomograph:

A practical and necessary parameter in the documentation process to provide accurate load credits is water content (WC) of PM recovered from maintenance operations. While the FSAEF study provided a very simple guidance table for water content, this was not a primary parameter in the previous study, assuming that a water content measurement would be made for the recovered PM in the documentation process. While the measurement is simple; the measurement is inconvenient and prone to be non-representative. For inside/outside reclaimed water areas, this objective is intended to further WC metrics, as had been produced in the FSAEF 2011 study for TP and TN.

(5) A 2nd generation interactive spreadsheet

An interactive synthesis spreadsheet that incorporates the proposed metrics will provide a more comprehensive and accurate load analysis template for a broader representation of MS4 conditions.

MATERIALS AND METHODOLOGY

The materials and methodology are detailed in the Quality Assurance Project Plan (QAPP) and therefore the details are not repeated herein. The QAPP is an appendix from the report and contains the methods, analysis procedures, and analysis quality assurance.

The 12 MS4s are listed below and Figure 1 illustrates the distribution of the participating MS4s across Florida for this phase of the project.

1. Naples (APF)
2. Brevard County (BC)
3. Escambia County (EC)
4. Gainesville (GNV)
5. Lee County (LC)
6. Orlando (MCO)
7. Pinellas County (PC)
8. St. Petersburg (PIE)
9. Sarasota County (SAC)
10. Seminole County (SEC)
11. Stuart (ST)
12. Volusia County (VC)

MS4 Sampling

Pursuant to the QAPP, each participating MS4 agreed to:

1. Identify 36 sampling locations (18 inside and 18 outside wastewater reclaimed areas) for PM-based samples as a function of hydrologic functional units (HFUs) and land use,
2. Provide sampling site data for each PM-based location and annual MS4 report or street sweeping data,
3. Collect 36 PM-based samples,
4. Identify, provide sampling site or process data and collect aqueous-based samples:
 - one set of final effluent samples of a wastewater treatment plant (WWTP),
 - one set of reclaimed effluent at a location in the distribution system that was spatially proximate to a PM-based sample from inside a reclaimed area of an MS4,
 - one set of influent rainfall-runoff samples to a best management practice (BMP) or catch basin (CB) outside of the reclaimed wastewater area,
5. Label all sample bottles based on project rubric, keep samples refrigerated and/or iced until delivery to University of Florida labs with a chain of custody,

PM-based samples were collected from three different HFUs within three different land uses inside and outside reclaimed wastewater areas for each MS4. The HFU classes were street sweeping (SS), catch basin (CB), and BMP. Figure 2 describes a conceptual illustration of hydrologic functional units (HFUs) sampled in this study. Land uses are highway (H), commercial (C), and residential (R). For any particular category, for example a PM sample of SS from highway land use pavement, there is variability. Therefore, for each HFU in each land use whether inside or outside the reclaimed water areas, PM-based samples were collected from two different locations. For GNV and BC, samples were collected from more than two locations for each HFU in a land use inside and outside the reclaimed wastewater areas, resulting in total of 59 and 48 samples, respectively. Figure 3 illustrates the summary of the final PM-based sampling matrix and the corresponding PM sample numbers in each category. Aqueous-based samples were collected for rainfall-runoff (designated as control), final effluent of a wastewater treatment plant (WWTP), and a distribution system nozzle at a spray discharge point in the reclaimed wastewater areas. Each MS4 submitted at least one pair of effluent and discharge samples inside the reclaimed water areas. Four control runoff samples (t = 0, 5, 10, 15 minutes from start of runoff) outside the reclaimed water areas were requested by each MS4. Figure 4 illustrates the summary of the final aqueous sampling matrix and the corresponding aqueous sample numbers in each category.

Cleaning and Decontamination

Pursuant to the multiple training sessions provided by the University of Florida, each MS4 was responsible for preparing and cleaning all sampling equipment used to collect all PM-based and aqueous samples. The street sweepers required cleaning with potable water prior to sweeping the sampling route. Detailed cleaning procedure for the sampling equipment and the sampling

bottles is provided in the QAPP. Figure 5 illustrate the examples of an equipment cleaning operation. All sample bottles which were new were cleaned with phosphate-free detergent and rinsed with potable water. When sample bottles were cleaned by the University of Florida when returning a set of bottles to the next MS4, bottles were cleaned with phosphate-free detergent, acid-washed, soaked in de-ionized water and allowed to air dry.

Sampling Methodology

Sampling was performed by each MS4 or their contractors. Procedures about the sampling method used for each sampling location is described in the QAPP. Each MS4 was tasked with providing field information for each collected sample. A description of the sampling tools or equipment utilized is given in the QAPP. The QAPP details the sampling information including a description of the sampling location and sample quantity that the MS4 was tasked with collecting. Figure 6 and Figure 7 show examples of the sampling process. The sample bottles were required to be labeled in detail with a project rubric. All samples were tied to a specific MS4, inside/outside reclaimed wastewater areas, HFU and land use through the rubric that was placed on each sample bottle. Figure 8 shows an example of the sample container labels.

Sample Preservation and Handling

After collection, both PM-based samples and aqueous-based samples were stored on ice or refrigerated until receipt at University of Florida. The samples were delivered by the MS4 to the laboratories at the University of Florida within the maximum holding time depending on the moisture condition of the sample. Details of preservation and delivery are provided in the QAPP.

Sample Field Information and Spatial Mapping

Each MS4 was tasked with providing a detailed sheet of field information related to each collected sample. An example with all the required field information for an Escambia commercial catch basin sample location is shown in Figure 9. Each MS4 was tasked with providing information including the spatial location of samples, water bodies in the area, photos associated with the locations, as well as local and major roadways. Figure 10 shows the spatial distribution of sampling locations in GNV as an example.

Sample Analyses

All analyses were performed by the University of Florida (UF) laboratories. Both PM-based and aqueous-based samples were collected by each participating MS4 and analyzed by UF. The following analyses were conducted for each PM-based sample subject to sufficient PM: moisture content (water content, WC), volatile particulate matter fractions (VPM) and particle size distribution (PSD) for PM size indices. Both fractional moisture content and total moisture content were measured. One set of sub-samples were generated from each sample with the gradation greater than 2000 μm and smaller than 2000 μm to measure the fractional moisture content. Another set of sub-samples were made by mechanically sieving into four gradations:

biological/biogenic materials visually identified irrespective of size, 75 to 2000 μm (sediment PM), 25 - 75 μm (settleable PM), and < 25 μm (suspended PM) (ASTM 1998, APHA 1998, Kim and Sansalone 2008). These sub-samples were analyzed for total phosphorus (TP) and leachable P, total Kjeldahl nitrogen (TKN), N species of nitrate-nitrite-nitrogen (NO_3^- -N, NO_2^- -N) and total ammonia nitrogen (TAN). N species and leachable P were aqueous phase concentrations and these values represent the aqueous phase of the nutrient results that were leached from the PM-based samples in this study. The result of TKN represents the sum of organic-nitrogen ($\text{N}_{\text{org-N}}$), ammonia (NH_3), and ammonium (NH_4^+). As a result, total nitrogen (TN) concentrations were approximated by summing the nitrate-nitrite-nitrogen with the TKN result. A summary table of applicable laboratory analyses for particulate and biogenic samples is presented in Table 1. The following analyses were implemented for each aqueous-based sample: conductivity, salinity, total dissolved solids (TDS), dissolved oxygen (DO), turbidity, redox, pH, alkalinity, PSD, suspended solid concentration (SSC), volatile suspended solids (VSS), total suspended solids (TSS) as suspended PM, settleable PM concentration, sediment PM concentration, TN, TP, and chemical oxygen demand (COD). A summary table of applicable laboratory analyses for aqueous samples is summarized in Table 2. Along with sampling and field information requirements identified in the QAPP, the project methods are located in the QAPP.

Statistical Analysis

Data were examined to determine the resulting distribution and distribution statistics of the project parameters and for generating representative comparative analyses. These examinations were Florida-based, as a function of HFUs, and land use. Results are summarized graphically and in a tabular framework. The primary project hypothesis was testing whether PM-based samples recovered by maintenance practices were nutrient enriched at a statistically higher level (at a 95% confidence level) inside wastewater reclaimed areas of Florida versus outside of wastewater reclaimed areas. In contrast to the Phase II results (Berretta et al. 2011) which focused on PM-based samples outside of reclaimed wastewater areas, in Phase III each MS4 has collected comparable number and distribution of samples (by HFU and land use) inside (IN) and outside (OUT) wastewater reclaimed areas to provide a defensible statistical metric and statistically significant numbers of samples.

For each land use and separately for each HFU a sufficient number of PM-based samples were required for project parameters (TN and TP) so that (1) the statistics of the parameter distribution, median, quartiles and range levels could be summarized from the quantitative distributions in the form of a non-parametric boxplot (no underlying probabilistic distribution, such as a Gaussian, lognormal or log-logistic is specifically required for such analyses); and (2) there were sufficient samples to test for any statistically significant difference between inside and outside wastewater reclaimed areas. In addition, the probability density function (PDF) and cumulative distribution function (CDF) were generated as a function of primary project parameters as a function of land use and HFUs. A log-logistic distribution was used to model the CDFs of the data. Log-logistic distribution is a continuous probability distribution for a non-

negative random variable, which has been applied in many fields (Gardner and Vogel 2005, Wagner and Løkke, 1991). The log-logistic distribution is similar in shape to the lognormal distribution model that described the Phase II results but has heavier tails. The heavy tail indicates that there is a larger probability of obtaining very large values, in this study, indicating higher PM-based nutrient concentration. Consistent with the previous lognormal distribution model from Phase II, the log-logistic model is a two-parameter model and has similar physical relevance. Model parameters α is an index for the model median (central tendency of PM-based concentrations) and β is an index for the model scale (the range of PM-based concentrations). Therefore, as with the lognormal distribution of Phase II, the log-logistic model is a simple two-parameter model where each parameter has a physical and practical interpretation.

A goodness-of-fit test was required to quantify how well the proposed log-logistic distribution model reproduced the data. The Kolmogorov-Smirnov test (K-S test) was the non-parametric test applied to indicate the equality of a continuous, one-dimensional probability distribution (Conover 1999, Massey 1951, Smirnov 1939). The test hypothesizes if a distribution of sample data comes from a population having a specific distribution (in this study, *a log-logistic model distribution*). This test hypothesis is that the project parameter data based on MS4 sampling follow the specific model distribution (log-logistic) within a selected confidence interval of 95%.

In this study, *datasets* were categorized (the primary project categorization was inside (IN) and outside (OUT) of wastewater reclaimed areas) and compared statistically. Mann-Whitney U test (MW test), also known as Wilcoxon rank-sum test, was selected to perform the non-parametric hypothesis test in order to assess for significant difference *between two categorized datasets* (Agresti 2003, D'Abrera and Lehmann 1975, Mann and Whitney 1947, MacFarland and Yates 2016, Wilcoxon 1945). The Mann-Whitney U test is the non-parametric equivalent of the t-test. Unlike the commonly used student t-test, the test does not require the assumption of a Gaussian (normal) distribution (Fay and Proschan 2010). This means that the test does not assume any properties concerning about the distribution of the datasets. The project was focused on categorizing and statistically comparing PM-based project parameters (TN and TP) from the categories of inside (IN) versus outside (OUT) wastewater reclaimed areas, different land uses, and HFUs. The M-W test is an effective tool to compare these categories from a statistical point of view. The applied hypotheses are indicated below for two categories of data, for example inside (x) versus outside (y) wastewater reclaimed areas.

The procedure to compare the two categorized data in this study was first to perform a two-sided hypothesis test and followed by a one-sided hypothesis test suggesting the statistical difference in one direction. Finally, the relationship between two categories of data is obtained.

A two-sided (two-tailed) hypothesis test that examines the statistically significant difference in either direction of a probability distribution can indicate if category x is greater than or less than category y. Therefore, the two-sided hypothesis test is testing for the possibility of the relationship in both directions. *In this study, the hypothesis test was to demonstrate the*

equivalence of two categories, for example, PM-based nutrients load inside and outside reclaimed wastewater areas. This null hypothesis (H_0) is that x and y have equal medians (50th percentile, the representative project parameter statistic) at a confidence level of 95% ($\alpha = 0.05$). The alternative hypothesis (H_1) is that x and y have different medians. The study has set an α value as 0.05. α is the significance level defined as the probability of the study rejecting the null hypothesis when the study result is true. When $\alpha = 0.05$, the test evenly allots α to testing the difference in each direction. Calculated p-value is the probability for a statistical model given that the null hypothesis is true. Under the null hypothesis, p-value is defined over [0, 1] interval. A small p-value ($< \alpha$) indicates strong evidence against the null hypothesis, so the result is statistically significant, and the test rejects the null hypothesis. A large p-value ($> \alpha$) indicates weak evidence to reject the null hypothesis, so the result is that the hypothesis test fails to reject the null hypothesis. (Lehmann and Romano 2006)

Furthermore, a one-sided hypothesis test was implemented if the null hypothesis of the previous two-sided test was rejected. One-sided test allots whole α to testing the statistical difference in the selected one direction and only the probability of the relationship in one direction is obtained. The alternative hypothesis can be made in the following forms as one-sided hypothesis test:

Right-tailed hypothesis test:

H_0 : the median of x is less or equal to the median of y ($\alpha = 0.05$).

H_1 : the median of x is greater than the median of y .

Left-tailed hypothesis test:

H_0 : the median of x is greater or equal to the median of y ($\alpha = 0.05$).

H_1 : the median of x is less than the median of y .

In summary, the equivalence of two categories of specific datasets (which is the null hypothesis for Phase III), for example inside compared to outside of wastewater reclaimed areas for primary project parameters of TN and TP, were determined based on the statistical hypothesis tests.

RESULTS

In presenting the Phase III results, the Phase II results are first reviewed. The median (50th percentile) is used for Phase II and III primary project parameters of TN and TP (and other project parameters such as water content, WC) to test the equivalency (or lack thereof) of dataset categories. Figure 11 summarizes Phase II results, presented as non-parametric distributions. If the comparison is paired between IN and OUT for only these 3 MS4s, the above results yields no significant difference by MW test. However, if the comparison is between IN (3 MS4s) and OUT (all 14 MS4s, denoted as OUT_all), TP from reclaimed-IN area is statistically significantly higher than OUT area. In contrast, there is no significant difference for TN. The Phase II report used the second comparison (all 14 MS4s). For consistency using a paired comparison methodology as is carried out with the Phase III report the result based on paired datasets (IN_3

vs. OUT_3) yields no statistical difference between IN and OUT for either TN or TP is consistent with Phase III. This Florida-based result from Phase II reinforces the historical use since 2011 of the set of Florida-based metrics that were given in the Phase II report (Berretta et al. 2011), irrespective of whether PM was recovered by any form of maintenance inside or outside of wastewater reclaimed areas. The one exception noted from Phase II is BMPs as a HFU which were shown to enrich PM with TP in wastewater reclaimed areas and this result has a mechanistically defensible basis as identified in the Phase II findings.

At the end of the report, Figure 46 provide an additional and further comparison between Phase II and III PM-based results for TN and TP utilizing the entire Florida-based databases (IN+OUT) from each phase or OUT only from each phase. The Phase III sample number from IN balance those from OUT of wastewater reclaimed areas which is not the case for Phase II whose samples were overwhelming from outside wastewater reclaimed areas. Noting the sample design differences between the project phases, Figure 46 results indicate that if IN+OUT are used to compare each phase (noting that this was not the study design in Phase II), there is a difference between phases. This comparison is of interest, but given the Phase II study design was significantly different than Phase III, no significant conclusion should be drawn between PM enrichment in nutrients, or lack thereof, when making a comparison between Phase II and III.

A brief discussion section regarding the statistical equivalence between Phase II and III results on a Florida-basis for PM-based TN and TP is appropriate at this point in presenting the results. The discussion is why there exists a statistical and numerical non-equivalence (reduction) of TP for Phase III which suggests the non-stationarity of TP associated with urban PM from the period of 2008 to 2010 (Phase II sampling) to the period of 2016 to 2018 (Phase III sampling) on a Florida basis? Is this result due to increased maintenance efforts and higher frequency of maintenance by MS4 to obtain nutrient load credits? Certainly, this may be one component of the non-stationarity (reduction) of TP; we know this from PM-based and therefore nutrient load data supplied by FDEP after the Phase II implementation in 2011 by Florida MS4s. If increased maintenance is a component of the statistical non-equivalence (reduction), pavement cleaning will likely be the practice that is driving this reduction. TP is marginally more particulate-bound across all HFUs and land uses than TN and therefore maintenance operations that target PM recovery will also relatively recover more TP than TN. As demonstrated in Phase II, recovery of TN and TP by maintenance practices, driven by pavement cleaning represents the dominant and most economical tool as compared to conventional and current BMPs (with few exceptions) in urban and suburban land uses. Irrespective of inclusion of wastewater reclaimed areas (the full Florida-based database) or exclusion, the statistical analysis in Figure 46 of the full databases (IN + OUT) from Phase II and III reach the same statistical result for TN and TP. An alternate explanation could be potential differences or representativeness of sampling, in particular in reclaimed wastewater areas where specific samples may not have been actually impacted by reclaimed wastewater in Phase III. While this is also a reasonable consideration, a major strength of the Florida-based set of analyses for Phase III is that such a consideration would potentially have had to occur across 12 diverse MS4s and across a large database.

The Phase III results are shown in more detail beginning with Figure 12. To reiterate, the primary goal of Phase III is to test the equivalency of inside as compared to outside wastewater reclaimed areas for the primary project parameters of PM-based TN, TP. Additional parameters, with WC specifically identified, are also compared later in the results. As a roadmap, Figure 12 through 25 represents a related set of inside and outside wastewater reclaimed area comparison of results. These results progress from the entire Florida-based database (results from all 12 participating MS4s) to comparisons that are more granular (more specific) in making comparisons between inside and outside wastewater reclaimed areas based on HFUs and land use.

Florida-based Phase III project results consistently demonstrate that there is a statistical equivalency between inside and outside of wastewater reclaimed areas at a 95% confidence level for PM-based TN and also TP. This primary project result is shown in Figure 12 for the entire Phase III Florida-based database (all samples). Figure 12 through 19 plot the cumulative distribution frequency (CDF), the accumulated frequency of occurrence of a PM-based concentration [mg/kg], for results of TN (and leached species of TN) on a Florida-basis and subsequently for HFUs and land use. The results are shown as histogram points as opposed to histogram bars which would obscure any graphical comparison and modeling result. Histogram results are modeled with the log-logistic distribution and the physical interpretation of model parameters as well as the KS and MW statistical testing are described in the Methodology and are not repeated herein. The model parameters, α , β , the median (50th % of CDF), the statistical equivalence p-value for the KS test of the model fit to the histogram results, and finally the statistical equivalence result when comparing project categories based on the MW test are provided in the inset table of each figure.

A brief discussion section regarding the statistical equivalence when comparing inside and outside wastewater reclaimed areas of Phase III results on a Florida-basis for PM-based TN and TP is appropriate at this point. There can be a reasonable and reasoned discussion of whether samples obtained from inside wastewater reclaimed areas actually received reclaimed wastewater flows; in particular street sweeping PM which may not have been subject to irrigation over-spray or run-on from irrigated right-of-way vegetated or landscaped areas. However, the project could not logistically ensure that each specific sample was directly impacted by reclaimed wastewater flows, only specifying that samples were obtained from inside wastewater reclaimed areas. In addition, the project goal was to sample from representative PM-based conditions in wastewater reclaimed areas. The hypothesis that a significant fraction of PM recovered, in particular from street sweeping, was not directly impacted by reclaimed wastewater is potentially reasonable, realistic and representative for an MS4; yet visual support would be required for each sample.

As with the BMP results from Phase II, the enrichment of PM by TP from reclaimed wastewater flows is expected and mechanistically defensible given the higher adsorptive capacity of PM for TP, with such capacity marginally greater than for TN in source areas. Furthermore, given that

PM in BMPs which receives urban flows can remain in an unmaintained BMP (resuspension and scour notwithstanding) for months if not years, PM and nutrients/chemicals, such as detained PM is continuously exposed to reclaimed wastewater that is either transported through the drainage system as dry weather flows or combined with runoff as part of a wet weather flow event. However, on a Florida basis that combines all HFUs and land use categories the enrichment of PM was not shown for TP given the rationale described in the previous paragraphs. On a Florida-basis results demonstrated a statistical equivalence at a 95% confidence level between inside and outside wastewater reclaimed areas for TN and TP. **Therefore, beyond results presented in Figure 12 which compared and demonstrated the statistical equivalence between inside (IN) and outside (OUT) wastewater reclaimed areas for Phase III, subsequent Phase III results lump all IN and OUT wastewater reclaimed areas for PM-based results.**

Figure 13 through 19 lump all Phase III MS4 results as (IN + OUT) for PM-based TN and leached species thereof. The inset table of each figure lists the log-logistic model parameters, the median and the p-value of the model fit. The inset non-parametric box and whisker plot provides the leached fraction (between 0.0 and 1.0) of TN. The leaching results were expanded beyond Gainesville to all 12 MS4s to develop the equivalent statistical power of TN and TP results. In these figures results indicate that the median of the leached fraction of PM-based TN did not exceed 2%. Results indicate that the predominant leached species of TN is organic nitrogen (N_{org}) and to a much lesser extent, total ammonia and NO_x species. These results are consistent irrespective of HFU and land use as shown in Figure 14 through 19. Non-parametric results are summarized in Figure 20 and 21 in which TN, organic nitrogen, NO_x and total ammonia are compared for statistical equivalence between specific HFUs and also between specific land uses. As compared to the entire Florida-based analysis which is consistent, the parsed results in Figure 20 and 21 are inconsistent at this level of granularity.

In a parallel framework to TN and the leached species thereof, the cumulative distribution frequency (CDF) results for PM-based TP are summarized in Figure 22 through 24 for all Phase III MS4 results (IN + OUT). Since leached species of TP from GNV were dominated by orthophosphates (HPO_4^{2-} and $H_2PO_4^-$) which accounted for more than 90% of the leached mass, the TP results were examined and shown as TP and leached phosphorus ($P_{leached}$). As with TN results the statistical equivalence results and the resulting parameters of the log-logistic model as well as the median values are reported in each figure. For all Phase III MS4 results the median leached fraction is approximately 10% as shown in Figure 22 with the inset box and whisker plot. Figure 23 provides a more granular evaluation of PM-based TP and the leached phosphorus fraction with the log-logistic model fit as a function of HFUs. The inset plot of the leached phosphorus fraction illustrates a consistent increase in the leached fraction through the drainage system; with the lowest value for street sweepings (SS) and the highest for BMPs which is consistent with typical unmaintained BMP conditions that would facilitate leaching of nutrients and chemicals from detained PM. Figure 24 provides a parallel set of results for TP as a function of land use. Leaching of TP is nominally higher than 10% for residential land use as compared

to highway or commercial land use which are nominally below 10%. Non-parametric results are summarized in Figure 25 in which TP and leached phosphorus are compared for statistical equivalence between specific HFUs and also between specific land uses. As compared to the entire Florida-based analysis which is consistent, the parsed results in Figure 25 are consistently demonstrating statistical equivalence between HFUs and land uses for TP but are inconsistent for leached phosphorus at this level of granularity.

In presenting the results of nutrient distributions as a function of PM-based size classes and operationally clarified fractions (settleable vs. suspended) a discussion is needed that serves as a foundation of the rationale applied for this part of the study. With respect to control of PM and nutrients generated and mobilized in MS4 systems, most pavement cleaning (street sweeping) operations are more effective at recovering coarser PM (the sediment fraction $> 75 \mu\text{m}$) and biogenic material than suspended PM. Similarly, conveyance, CBs and BMPs are most effective at separating and retaining (until maintenance) coarser PM, whether by design or unintentionally given that CBs and pipe sewers are intended to be self-cleaning. By definition, there is a gradient of nutrient concentrations as a function of PM granulometry, specifically operational PM size classes, and also the organic (biogenic) PM. Phase III separated and examined the operational PM size classes of suspended PM ($< 25 \mu\text{m}$), settleable PM, and sediment PM ($> 75 \mu\text{m}$ to $2000 \mu\text{m}$) as well as the biogenic fraction. TN and TP for each operational size class was examined. In addition, total PM (all PM) was examined for TN and TP.

There is a physical and operational rationale for the PM classes examined herein. Suspended PM is not effectively separated by BMPs, including most filters except ripened filters, or not effectively recovered by conventional Florida street sweeping. Operationally and by definition, suspended PM is PM that remains suspended in an Imhoff cone for one hour. Finer suspended PM are the most bio-available particles, colloids ($< 1 \mu\text{m}$) notwithstanding. Suspended PM is the most mobile (including resuspension and scour) but least labile. Operationally, settleable PM is PM that settles in an Imhoff cone at one hour and is separated to a greater extent than suspended PM in larger surface area BMPs such as wet retention basins and by properly designed media filters. The settleable PM class is also recovered by street sweeping, depending on the operation of the street sweeper, to a greater extent than suspended PM. Sediment PM is greater in diameter than $75 \mu\text{m}$ (#200) sieve, the nominal delimiter between coarse and fine PM, but PM that is smaller than gravel size ($> 2000 \mu\text{m}$) by definition. Most BMPs that are well-maintained are capable of separating sediment PM to a greater extent than settleable PM, even in small-footprint manufactured BMPs. However, sediment PM is the most labile size class ($> 2000 \mu\text{m}$ notwithstanding) and such lability results in nutrients or chemicals that repartition to the aqueous phase and transported out of a BMP or wet sump CB that are not maintained on a regular basis.

The distribution of TN and TP as a function of the operational PM size class or biogenic fraction as well as total PM are shown in Figure 26 through 31. The volatile fraction, as an index of the organic component for each PM size class or fraction are shown in Figure 32 through 34. The clear trend is that PM-based concentration [mg/kg] increases with decreasing particle size class,

by definition of a PM-based concentration that is a function of diameter. This should not be confused with the distribution of nutrient or chemical mass that increases with increasing PM operational size class. While the inversion of PM-based concentration and PM-based mass of a nutrient appears dichotomous initially, there is a physical rationale and basis in MS4s. As shown in Table 8, the predominant PM mass fraction is the sediment PM fraction irrespective of the >2000 μm fraction. While the PM-based concentration of the sediment fraction is lower than suspended PM, the overall mass fraction of sediment PM separated or recovered is much higher.

Therefore, the PM-based limiting conditions for management of MS4 PM are as follows. Suspended PM has (1) the highest bio-availability, (2) the highest PM-based concentration, (3) the highest resuspension/scour from BMPs, (4) the lowest separation by BMPs and (5) lower overall mass capacity of the urban PSD. In comparison, sediment PM has (1) the lowest bio-availability, (2) the lowest PM-based concentration, (3) the lowest resuspension/scour once separated by a CB or BMP, (4) a higher BMP-based separation and (5) a higher overall mass capacity that is subject to lability in BMPs, CBs with wet sumps or wet urban conveyance systems. Unequivocally, recovery of PM, in particular from pavement cleaning must be a priority for the intended functionality of urban conveyance systems and BMPs. However, this also will result in BMP performance, more so in small footprint manufactured units, that will be much lower than specified performance because PM and associated nutrients/chemicals are much more effectively and economically recovered upstream of the BMP. However this can potentially extend the maintenance frequency for many BMPs. One of the many benefits of a physically-validated computational fluid dynamics (CFD) coupled with the Storm Water Management Model (SWMM) is that BMP behavior can be quantified under any set of loading conditions, including temperature, PSD, concentration, species, partitioning, maintenance frequency without the costly use of repeated physical testing under variably conditions. This also allows portability of BMP results from location to location with a physically validated set of models (Garofalo and Sansalone 2019, Li and Sansalone 2019, Spelman and Sansalone 2018).

The results in Figure 26 through 31 support the previous discussion. The gradient of PM-based concentration [mg/kg] increases from sediment to suspended PM. The biogenic fraction is generally of higher or similar concentration to the suspended fraction. An overall weighting on a mass fraction basis across the PSD yields a total PM-based concentration that is most similar to the sediment PM concentration. This result illustrates that sediment PM dominates the urban MS4 PSD in urban source areas. Figure 32 of the volatile fraction of PM show an increasing volatile fraction (%) from sediment to suspended PM. Parallel to the biogenic fraction results, the volatile fraction is generally of a similar level to that of the suspended fraction. Whether examined in terms of IN + OUT, IN versus OUT, or in a more granular evaluation as a function of HFU or land use; these trends are consistent in Figure 32 through 34.

In terms of accurate load recovery reporting for PM and therefore PM-based nutrients of TN and TP, water content (WC) is a simply-measured and critically important parameter to be able to defensibly assess the dry weight of PM whether on a gravimetric or volumetric (through a

measured bulk density) basis. The dry weight of PM was the basis of the Phase II project and is the basis of the Phase III project. While WC does not provide a direct outcome as compared to PM recovery and reporting, the accurate representation of dry PM load and therefore nutrients [mg of nutrient/dry kg of PM] is essential for all stakeholders.

For WC on a Florida-basis there is a statistically significant increase in WC for IN (inside wastewater reclaimed areas) as compared to OUT (outside wastewater reclaimed areas). In terms of modeling this WC distribution, Figure 35 summarizes the log-logistic distributions of WC for IN + OUT, IN and OUT with a fit to the WC histogram results. On a more granular basis the differences in WC as a function of HFU are shown in Figure 36 and for land use in Figure 37. Figure 38 (IN and OUT) through 40 provides a WC comparison between $< 2000 \mu\text{m}$ and $> 2000 \mu\text{m}$ as a function of HFU and land use. The correlations between previous dry hours (PDH) and WC for SS are given for inside and outside wastewater reclaimed areas in Figure 41. While there is significant scatter in the data noting that one project requirement was no street sweeping occurred until a PDH of 24 (24 previous dry hours); Figure 41 shows a regression lines with 95% confidence bounds that was produced from the results. The WC regression line for IN had a higher WC intercept at 24 hours and greater negative slope with increasing PDH as compared to OUT. The higher point values of WC that are shown in Figure 41 are challenging to physically explain. Possible explanations are that overspray still wet the pavement and therefore also wet PM pavement deposits during street sweeping operations or that the street sweeping equipment still contained free water.

Irrespective of Figure 41, Table 3 reports the central tendency (the median) of WC for IN and OUT as a function of HFUs. These results clearly illustrate that SS from IN has a higher WC than OUT. The pattern of higher WC for IN as compared to OUT is consistent for SS, CBs and BMPs. As would be expected in moving down the conveyance system of an MS4, WC increases from SS to CBs to BMPs as summarized in Table 3. Because of the requirement to report an accurate dry PM mass and given the significant differences in WC between IN and OUT and as a function of HFU, the specific WC values in Table 3 should be used going forward. An alternative to the central tendency of WC given in Table 3, Figure 41 provides a WC monograph where actual PDH value can be documented for use in Figure 41.

Loadings of nutrients from reclaimed wastewater and from rainfall-runoff were evaluated. As part of this evaluation of nutrient loadings from within wastewater reclaimed areas and results were compared to outside wastewater reclaimed areas. Specifically, (1) wastewater at the discharge point of an MS4 wastewater treatment plant (WWTP) whether through secondary or advanced treatment, (2) at a discharge point in an MS4 reclaimed wastewater distribution system, typically just upstream of a CB or BMP, and (3) rainfall-runoff (control) across the first 15 minutes of runoff were evaluated. The first 15 minutes of runoff was chosen as a common time metric for all runoff as a control with respect to wastewater and reclaimed discharges; noting that the concept of a metric or delimiter for an event-based “first-flush” or more recent re-incarnations such as a water quality volume is never known a-priori and has been shown to be an

erroneous concept for capture/treatment of loads (Sansalone and Cristina 2004, Sheng et al. 2008). An examination of a first-flush for nutrients, PM and thermal enrichment require a relationship between load transport as a function of cumulative runoff volume; no different than a BMP (Berretta and Sansalone 2011, Kertesz and Sansalone, 2014, Zhang and Sansalone 2014). Results are summarized as non-parametric distributions in Figure 42 for TN and total dissolved nitrogen (TDN) and in Figure 43 for TP and TDP. In the distribution system there is no significant decrease in TN or the TDN as compared to the wastewater effluent. The effluent and reclaimed wastewater discharge point produced TN and TDN that are statistically significantly greater than runoff. In contrast to a first-flush concentration-based definition (a first-order, exponential decline in concentration) the decline in TN and TDN was approximately a zero-order, linear, decline in concentration. In the distribution system there is no significant decrease in TP as compared to the effluent and a decrease in TDP, likely through partitioning to PM that is settled or taken up by the distribution system biofilm. Both effluent and discharge point TP and TDP are statistically significantly higher than TP and TDP in runoff. TP and TDP exhibit an approximate zero-order decline in concentration during the first 15 minutes of runoff.

Unit Area Example

A sample result is a point result in time and space, in this case at the urban surface so the sample is reduced to a point result for an area. The analog to this is the weighting of a network rain gage results for a given watershed area by methods such as Thiessen polygon method. An example of areal-weighting for PM and nutrients are illustrated with the selected unit area as shown in Figure 44. This selected unit area locating in GNV and is a square with a width of approximately 2.45 miles and an area of 6 mi². The GIS information to this square area is also shown in Figure 44 as x and y coordinates in decimal degrees located along the four unit boundaries.

There are total 32 sampling locations in the unit area, among which there are 11 street sweeping (SS) sampling routes, 11 sampling points as catch basins (CB), and 10 sampling points as best management practices (BMPs). The sweeping length is measured for each SS route, and a contributing width of approximately 50 feet from a four-lane pavement with standard 12 feet lane width is assumed. A CB collects the pavement sheet flow from the paved gutter on both sides of the pavement assuming the pavement is crowned at centerline. On each side of the roadway pavement, the CBs are spaced at approximately 400 feet. A 2000 m² (21,528 ft², approximately ½ acre) pavement area (as replicated from the Phase II report as shown in Table S 2, Berretta et al., 2011) draining through CBs to a small BMP is assumed in Phase III consistent with Phase II. Samples from each sampling point were taken and analyzed in Phase III.

This unit area and the samples are identified in Figure 44 and the unit area is divided into the respective three land uses. Residential (R) area is identified with Florida land use, cover and forms classification system (FLUCCS code). Primary, secondary and connecting road, interstate, U.S. and state highway are identified based on the U.S. Census Bureau's Census Feature Class Codes (CFCC) to be highway (H) area. The assumption of a 48-foot pavement width is also

made here. And the remaining area are counted to commercial (C) land use. Area for each land use is reported in Table 10. All GIS files were provided by the City of Gainesville (GNV).

Combination of three land uses and three HFUs provides a total of nine sampling categories. If only one land use is examined, for example the residential area, there are a total of six sampled locations. In the residential area calculations: (1) the product of each measured PM and nutrient concentration value multiplied by the sample's contributing residential area are summed, (2) divide the summation of the products by the entire contributing residential area. Thus, an area weighted nutrient concentration value for only the residential area is calculated as shown in Table 9. Measurements of total nitrogen (TN) and total phosphorus (TP) are both presented.

Results for all 3 land uses are calculated using the same method and showed in Table 10. A second area weighted calculation based on the mean nutrient concentration of each land use and the land use area, is then conducted for the final result. In this particular selected area, the areal-weighted total nitrogen is 4659 mg of TN/ kg of PM, while the areal-weighted total phosphorus is 1117 mg of TP/ kg of PM.

The Economics of Maintenance

Similar to what was carried out for Phase II nutrient and PM recovery loads for outside of wastewater reclaimed areas, this section re-iterates the PM-associated nutrient recovery costs economics for BMPs and maintenance practices in parallel to the Phase II report (Berretta et al., 2011 Table S 2); but using the Phase III nutrient data. Phase III uses nutrient concentrations as mg/kg of dry PM recovered from street sweeping (SS), catch basin (CB) cleaning or BMP maintenance. Since for Phase III data there is no statistically significant difference in the PM-based nutrient concentrations between IN and OUT the results include both IN and OUT. The summary of Florida-based metrics developed is organized in Table 3. These metrics are a function of HFU. Table 4, Table 5 and Table 6 separately summarize the quartiles of nutrient concentrations and water content (WC) as a function of HFU and land use. By lumping the effect of land use and with no statistical significance between inside and outside wastewater reclaimed areas, Table 7 shows the quartiles of nutrient recovery concentrations across Florida MS4s solely as a function of HFU.

For simplicity, an example of the relative economics for Gainesville is illustrated by using the Florida-based metrics that are assumed to be independent of land use as shown in Table 7. The economics of PM and PM-associated nutrients recovery from the maintenance practices of two HFUs: (1) street sweeping (2) catch basin (CB) cleaning are illustrated as compared with the economics of BMPs.

Load Recovery and Cost Method for Street Sweeping (SS):

Based on the street sweeping results of the Phase II report (Berretta et al., 2011), a median of 147 kg PM/mile swept is applied to this example, assuming a non-parametric distribution of street sweeping results. The values shown in Figure 36, Figure 39 and Table 3 can be used to determine the relationship between the dry and wet mass of PM. For example, the median value

of water content from street sweeping is used (3.90%). Given the results in this Phase III report, PM, TN and TP load recovery can be quantified.

The metrics of this report are used to convert directly from the dry-equivalent of recovered PM mass from street sweeping to a TN or TP mass. A similar process is also presented later for CBs and BMPs. For example, on a Florida-basis irrespective of land use, based on Table 7, the median concentration of TP is 303 mg/kg of PM and for TN is 656 mg/kg of PM. Nutrient mass recovered per mile swept is estimated by subtracting the moisture mass (water content) from the moist mass of PM per mile swept to obtain the dry-equivalent mass and then multiplying by the nutrient concentration as mg/kg. The cost is obtained by multiplying the total mass of TN or TP to the unit price for maintenance.

The following steps are a methodology to calculate nutrients recovery and cost of street sweeping on an annual basis:

- 1) Measure the lane miles swept and weigh the PM mass collected through pavement cleaning; correcting for water content. In this example, Florida-based metrics are used for estimation. The median value for PM mass recovered by street sweeping is 147 kg PM/mile (Berretta et. al, 2011 in the Phase II report). The median water content for street sweeping is 3.90% (Figure 36, Figure 39 and Table 3). The dry-equivalent PM mass per mile is calculated by subtracting the moisture mass.
- 2) Calculate dry PM-based nutrients recovered by using the median values in Table 7 of Phase III for SS; these values are 303 mg TP/kg of PM and 656 TN mg/kg of PM. Multiplying these values by the PM recovered per mile, the total nutrient mass recovered is determined in lb/mile.
- 3) To estimate the annual basis nutrients recovery based on the distance of pavement swept. As provided by GNV, the total distance of main roads in GNV is 880 miles. The cleaning frequency is assumed on a monthly basis.
- 4) To estimate the cost of street sweeping according to the Table S 2 in Phase II report (Berretta et al., 2011). The median cost of street sweeping for TP and TN per pound are \$257 and \$165 based on 2011 costs. By multiplying these values by the recovered nutrients mass on an annual basis, the cost of street sweeping is obtained.
- 5) To recovery 1.0 lb of TP and TN the miles need to be swept can be calculated.

Load Recovery and Cost Method for Catch Basins (CB):

A catch basin is a curbside drain with the sole function as a hydraulic conveyance for collecting runoff from pavement and drainage areas and transporting concentrated flow to the conveyance system. These can be a curb inlet, an area catch basin, a pavement catch basin. Catch basins are designed to be mostly self-cleaning, are required for drainage and do not provide a treatment function. Therefore, as suggested in the Phase II report (Berretta et al., 2011), the CB cost of construction is not considered in the cost. Only the CB cost of basin maintenance is included.

In this example, as with the Phase II results, the assumption is that 100 dry lb of PM mass is annually recovered per each catch basin cleaned. In Table 7, the median TN concentration for a

catch basin is 891 mg/kg PM and for TP is 339 mg/kg PM. With GNV as the example, the number of CBs is approximately 18000 although GNV was not able to supply the number of CBs or cleaning frequency; there assumed to be cleaned once per year. A once per year frequency is unrealistic but is simply intended to illustrate a hypothetical upper limit of recovery.

The following steps show the procedure to calculate nutrients recovery and cost of catch basin cleaning in annual basis:

- 1) Assume that 100 lb dry PM mass is recovered per catch basin once a year by maintenance.
- 2) To estimate nutrients recovered with the assumed PM mass recovered, apply the median values in Table 7. For TN (891 mg/kg of PM) and for TP (339 mg/kg of PM). The total mass of TN and TP per catch basin per annual cleaning can be calculated.
- 3) The annual-based mass of TN and TP recovered in GNV is determined by multiplying the mass of TN and TP recovered from one catch basin by the number of catch basins in GNV.
- 4) To calculate the cost of catch basin maintenance based on the summary in the Phase II report (Berretta et al., 2011), in GNV, the cost of catch basin cleaning for TN is \$1,016/lb, and for TP is \$1,656/lb. The cost of cleaning can then be obtained for GNV for all catch basins on an annual basis as an upper limit of cost.
- 5) To recovery 1.0 lb of TN and TP, the number of catch basins can then be calculated.

Load Recovery and Cost Method for BMPs

For management of PM/TN/TP load, hydrologic control notwithstanding, a BMP is a structural unit operation/process utilized primarily for PM-based separation whether through sedimentation and/or filtration (and possibly nutrient mass transfer) noting that PM is the dominant media substrate to accumulate nutrient loads inside/outside BMPs, not engineered media utilized in Florida filters (FDEP, 2009; Wu and Sansalone, 2013a, Wu and Sansalone 2013b). There are many BMP types in Florida, including basins, tanks, filters, vaults, clarifiers, and hydrodynamic separators (HS). These BMPs including filters are mainly gravitational settling systems for PM. HS units are smaller footprint than many BMPs; the high flow intensity through HS types leads to scouring and washout without regular maintenance (Pathapati and Sansalone 2012, Cho and Sansalone 2013). Therefore when used for loads, cost of the BMP and maintenance are included.

The cost estimation of BMP in this example is calculated by the following assumptions:

- 1) A BMP system with an urban drainage area of 2000 m²
- 2) Treatment with annual PM removal efficiency of 50% based on clean sump conditions (rare, BMPs are rarely cleaned and 50% in real urban systems is an over-estimation), larger surface area wet basins not considered in this example,
- 3) No scouring and washout PM (based on a clean sump condition, again rare)
- 4) Annual rainfall depth is 50 inches (30-year Gainesville historical data series from NOAA-National Oceanic and Atmospheric Administration)
- 5) Volumetric rainfall runoff coefficient (C) is 0.75

- 6) A total PM concentration of 200 mg/L
- 7) Multiple catch basins connecting to one BMP or BMP system

The following steps show the procedure to calculate nutrients recovery and cost of BMP maintenance in annual basis:

- 1) The recovered PM mass is based on the yearly runoff volume drained into the BMP which is 1905 m³ calculated by multiplying annual rainfall depth by the drainage area and rainfall runoff coefficient. By multiplying by the PM concentration and considering the removal efficiency of the BMP, the resulting annual value is 840 lb of PM separated (retained) by the BMP.
- 2) To estimate the nutrients recovery associated with the PM mass obtained, use Table 7 for BMPs and these results yield 1209 mg TN/kg of PM and 291 mg TP/kg of PM. By multiplying these values by the recovered PM mass in the BMP results, the mass of nutrients separated from one BMP can be calculated.
- 3) Multiplying the mass of TN and TP recovered in one BMP by the number of BMPs in GNV yields the annual-based mass of TN and TP recovered in GNV. The number of BMPs is assumed to be approximately 5000, GNV did not provide supporting information on BMPs, and this number of BMPs is assumed to be cleaned annually. This is not reality but again serves as an upper limit of PM and nutrient recovery. The calculation yields the load of TN and TP recovered.
- 4) To calculate the cost of BMP based on the summary in the Phase II report (Berretta et al., 2011), in GNV, the cost of BMP construction for TN is \$1,900/lb, and for TP is \$10,500/lb from the Florida based BMP category. The results are the cost of BMPs to recover TN and also TP.
- 6) To recovery 1.0 lb of TN and TP, the number of BMP needed can be calculated.

While the cost of SS is in the hundreds of thousands of dollars for GNV, the cost of CB cleaning under the upper limit assumptions is on the order of a million dollars for GNV, while the cost of BMPs needed to recover an equivalent mass of TN and TP as SS is on the order of ten million dollars. These assumptions can be better refined for better CB and BMP data from an MS4 but these more realistic assumptions will only lower the relative recovery of PM, TN and TP for CBs and BMPs; noting that the cost and recovery of SS is much more realistic and accurate because of the unknown number of CBs and BMPs in GNV and the maintenance or lack thereof. Even with better refinement the results point to the overwhelming benefit of SS. The differential benefit of SS compared to adding the equivalent number of BMPs needed for such load recovery has been shown to be equivalent to tens of millions of dollars for a moderate size MS4 in Florida through spreadsheet PM data provided by FDEP and presented to the FSA Annual Conference in 2018. These SS and BMP cost comparison results are expected and defensible. While BMPs such as wet basins are needed for hydrologic management objectives most BMP are ineffective from a load sequestration and certainly from an economic point of view. Source control through SS can benefit CBs and BMPs. Current BMPs especially smaller footprint manufactured BMPs are ineffective and when BMPs are needed must be designed for soluble chemicals/nutrients

control with more effective BMP design and implementation through a coupling of SWMM and computational fluid dynamics, CFD that are validated through physical modeling/monitoring. Additionally, PM examined from this study when managed, actually functions as a more effective media for nutrient adsorption or conversion than current media deployed in Florida.

CONCLUSIONS

The context of Phase III from which the conclusions are elucidated is important. Phase III built on Phase II results (Berretta et al. 2011) which examined PM-based TN and TP from 14 Florida MS4s for outside of reclaimed wastewater areas. However in contrast to Phase II, a primary objective of Phase III was examination of PM-based TN/TP from 12 Florida MS4s with paired sampling from inside (IN) and outside (OUT) wastewater reclaimed areas. In addition, aqueous-based sampling compared MS4 wastewater treatment plant (WWTP) effluent, reclaimed wastewater discharge from the distribution system from IN areas, and runoff from OUT areas as an aqueous-based control. As with Phase II, Phase III examined residential, commercial and highway land uses; and street sweeping (SS), catch basins (CBs) and best management practice (BMP) hydrologic functional units (HFUs). Both projects examined water content (WC) of the recovered PM, a critical objective for a representative accounting of dry PM given that load credits for TN/TP are only based on dry PM mass. Additional objectives are a WC nomograph, leaching fractions from PM-based TN/TP, the mass-based distribution of PM size fractions, and an updated interactive spreadsheet based on Table 3 results. The conclusions are as follows:

1. As a complete set of results from all 12 MS4s (Florida-basis) Phase III results are statistically defensible at a 95% confidence level. As results are parsed and made more granular, for example for specific MS4s with much lower statistical power, conclusions vary depending on the granularity of the parsing and cannot consistently be defended at a 95% confidence level.
2. At a 95% confidence level the PM-based TN and TP [mg/kg of dry PM] are not statistically significantly different between IN and OUT based on a comparison of the representative statistic (the median, 50th percentile) from the IN and OUT distributions. As a result Phase III results were combined for IN and OUT, although project summary results (Table 3) provide IN, OUT and IN+OUT statistics. A discussion of physically-based explanations is given in the Results section for the statistical equivalence between IN and OUT.
3. As summarized in the results and legends of Figure 11 and 46; for TN there was statistical equivalence to a less than equivalence between Phase II and III; for TP Phase II was higher than Phase III. A physically-based discussion is given in the Results section.
4. PM-based TN and TP as well as leached species thereof were modeled as a log-logistic model for the cumulative distribution frequency (CDF) with physically-based parameters for all 12 MS4s and for the combined IN+OUT wastewater reclaimed areas. The median of the leached fraction of PM-based TN did not exceed 2% predominately as organic nitrogen (N_{org}). The median of the leached fraction of PM-based TP was approximately 10% predominately as orthophosphates. BMPs produced the highest leaching for TP.
5. There is a statistically significant increase in WC (Florida-basis) for IN compared to OUT indicating WC enrichment of PM from irrigation run-on. The medians are reported in Table 3. Results demonstrate that SS, CBs and BMPs from IN have a higher WC than OUT.
6. PM-based concentration [mg/kg] increases from sediment (most labile) to suspended (most bio-available; not effectively separated by BMPs) PM while on a mass basis PM/nutrient are

dominated by the sediment fraction which dominate the urban PSD and the maintenance and the recovery thereof. PM is the dominant media substrate to accumulate nutrient loads whether inside or outside BMPs/CBs, not engineered media utilized in Florida BMPs or CBs.

7. Consistent with Phase II results, SS as a maintenance practice dominated load recovery of PM, TP, TN compared to BMP and CB maintenance with highly favorable economics compared to BMP installation for loads; hydrologic considerations such as for wet basins notwithstanding. SS is a practice that benefits the behavior/functionality of CBs and BMPs.

REFERENCES

- Agresti, A. (2003). "Categorical data analysis." Vol. 482. John Wiley & Sons, New York, NY, USA.
- APHA. American Public Health Association. (1998). "Standard Methods for the Examination of Water and Wastewater." (20th Ed.) A.D. Eaton, L.S. Clesceri, A.E. Greenberg (Eds.), American Public Health Association, American Water Works Association and Water Environmental Federation, Washington, D.C.
- ASTM. (1998). "Standard Practice for Dry Preparation of Soil Samples for Particle-Size Analysis and Determination of Soil Constants." ASTM D 421-98 and ASTM D 422-63, West Conshohocken, PA.
- ASTM. (1998). "Standard Test Method for Laboratory Determination of Water (Moisture) Content of Soil and Rock by Mass." ASTM D 2216-98, West Conshohocken, PA.
- Berretta, C., Raje, S., Sansalone, J., (2011). "Quantifying Nutrient Loads Associated with Urban Particulate Matter (PM), and Biogenic/litter Recovery through Current MS4 Source Control and Maintenance Practices." Final Report to Florida Stormwater Association Educational Foundation, Tallahassee, FL. Available at: <https://www.florida-stormwater.org/assets/FSAEF/Research/MS4/ms4%20assessment%20project%2011%20final%20report.pdf>
- Berretta C, Sansalone J (2011). "Hydrologic transport and partitioning of phosphorus fractions." *Journal of Hydrology*, 403(1-2), 25-36.
- Carpenter, S. R., Caraco, N. F., Correll, D. L., Howarth, R. W., Sharpley, A. N., and Smith, V. H. (1998). "Nonpoint pollution of surface waters with phosphorus and nitrogen." *Ecological Applications*, 8(3), 559-568.
- Cho H-C. and Sansalone J (2013), "Physical Modeling of Particulate Matter Washout from a Hydrodynamic Separator", *ASCE J. of Environmental Engineering*, 139 (1), 11-22.
- Conover, W. J. (1999). "Practical Nonparametric Statistics." John Wiley & Sons, New York, NY, USA, third edition.
- D'Abrera, H. J. M., and Lehmann, E. L. (1975). "Nonparametric: statistical methods based on ranks." Holden-day
- Dean, C. M., Sansalone J. J., Cartledge, F. K., and Pardue, J. H. (2005). "Influence of Hydrology On Rainfall-Runoff Metal Element Speciation." *ASCE Journal of Environmental Engineering*, 131 (4), 632-642.

- Fay, M. P., and Proschan, M. A. (2010). “Wilcoxon-Mann-Whitney or t-test? On assumptions for hypothesis tests and multiple interpretations of decision rules.” *Statistics surveys*, 4, 1.
- FDEP (Florida Department of Environmental Protection) (2009). “FDEP Contract Number WM 910 Management of Source Area Runoff Using In-situ Controls”, Final Report, September 2009.
- Gardner, K. K., and Vogel, R. M. (2005). “Predicting ground water nitrate concentration from land use.” *Groundwater*, 43(3), 343-352.
- Garofalo, G. and Sansalone J. (2019). “Modeling annual particulate matter separation by unit operations with CFD.” *ASCE Journal of Environmental Engineering*, (in press).
- Huber, S.; Prokop, G.; Arrouays, D.; Banko, G.; Bispo, A.; Jones, R.J.A.; Kibblewhite, M.; Lexer, W.; Moller, A.; Rickson, R.J.; et al. Environmental Assessment of Soil for Monitoring: Volume I Indicators & Criteria; Office for the Official Publications of the European Communities: Luxembourg City, Luxembourg, 2008; p. 339.
- Hvitved-Jacobsen, T., and Yousef, Y. A. (1991). “Highway runoff quality, environmental impacts and control.” *Highway pollution, studies in environmental science*, R. S. Hamilton and R. N. Harrison, eds., Vol. 44, Elsevier Science Publishers, Amsterdam, 165–208.
- Hvitved-Jacobsen, T., Johansen, N. B., and Yousef, Y. A. (1994). “Treatment systems for urban and highway runoff in Denmark.” *Science of The Total Environment*, 146–147, 499–506.
- Jenkins, D., Ferguson, J. F., and Menar, A. B. (1971). “Chemical processes for phosphate removal.” *Water Resources*, 5(7), 369–389.
- Jirka, A.M.; Carter, M.J. (1975). “Analytical Chemistry.” 47(8), 1397.
- Kertesz, R. and Sansalone, J. (2014). “Hydrologic Transport of Thermal Energy from Pavement.” *Journal of Environmental Engineering*, 140(8).
- Kim, J. Y., and Sansalone, J. J. (2008). “Event-based size distributions of particulate matter transported during urban rainfall–runoff events.” *Water Research*, 42(10–11), 2756–2768.
- Lehmann, E. L., and Romano, J. P. (2006). “Testing statistical hypotheses.” Springer Science & Business Media.
- Li, H. and Sansalone J. (2019). “A CFD model of PM sedimentation and resuspension in urban water clarification.” *ASCE Journal of Environmental Engineering*, (in press).
- Liu, B., Sansalone, J., and Ying, G. (2010). “Volumetric filtration of rainfall-runoff: Separation of PM and filter forensics.” *ASCE Journal of Environmental Engineering*, 136(12), 1321-1330. [https://doi.org/10.1061/\(ASCE\)EE.1943-7870.0000285](https://doi.org/10.1061/(ASCE)EE.1943-7870.0000285).
- Ma J., Ying G, and Sansalone J (2010). “Transport and distribution of particulate matter phosphorus in rainfall-runoff from roadway source areas.” *ASCE Journal of Environmental Engineering*, 136(11), 1197-1205.
- MacFarland, T. W., and Yates, J. M. (2016). “Introduction to nonparametric statistics for the biological sciences using R.” Cham: Springer (Chapter 4).
- Mann, H. B., and Whitney, D. R. (1947). “On a test of whether one of two random variables is

- stochastically larger than the other.” *The annals of mathematical statistics*, 50-60.
- Massey, F. J., Jr. (1951). “The Kolmogorov-Smirnov test for goodness of fit.” *Journal of the American Statistical Association*, 46, 68-78.
- National Oceanic and Atmospheric Administration (NOAA)
- Available at:
<https://forecast.weather.gov/MapClick.php?CityName=Gainesville&state=FL&site=JAX&textField1=29.6742&textField2=-82.3363&e=0#.XKqevZhKjct>.
- Pathapati S. and Sansalone J (2012), “Particulate matter re-suspension and scour from urban drainage hydrodynamic separators”, *ASCE J. of Environmental Engineering*, 138 (1), 90-100.
- Piro, P., Carbone, M., Garofalo, G., and Sansalone, J. (2010). “Size distribution of wet weather and dry weather particulate matter entrained in combined flows from an urbanizing sewershed.” *Water, Air, and Soil Pollution*, 206(1-4), 83-94.
- Pitt, R., Maestre, A., and Morquecho, R. (2004). “The national stormwater quality database (NSQD, version 1.1).” 1st Annual Stormwater Management Research Symp. Proc., Univ. of Central Florida, Orlando, FL, 13–51.
- Sansalone, J., Asce, M., Liu, B., & Ying, G. (2010). Volumetric Filtration of Rainfall Runoff . II : Event-Based and Interevent Nutrient Fate. *Public Health*, 136(December), 1331–1340.
- Sample, D., and Heaney, J. (2006). “Integrated management of irrigation and urban storm-water infiltration.” *Journal of Water Resource Planning and Management.*, 132(5), 362–373.
- Sansalone J. J and Kim J. Y. (2008). “Transport of Particulate Matter Fractions in Urban Source Area Pavement Surface Runoff.” *Journal of Environmental Quality*, 37:1883–1893.
- Sansalone J. and Cristina C.M. (2004). “First Flush Concepts For Suspended And Dissolved Solids In Small Impervious Watersheds.” *Journal of Environmental Engineering*, 130 (11), 1301-1314.
- Sansalone J., and Ma J. (2011), “Parametric analysis and breakthrough modeling of phosphorus from Al-oxide filter media.” *ASCE Journal of Environmental Engineering*, 137(2), 108-118.
- Sheng Y, Ying G, Sansalone J. (2008), “Differentiation of transport for particulate and dissolved water chemistry load indices in rainfall-runoff from urban source area watersheds.” *Journal of Hydrology*, 361(1-2), 144-158.
- Shinya, M., Tsuruho, K., Ishikawa, M. (2003). “Evaluation of factors influencing diffusion of pollutant loads in urban highway runoff.” *Water Science Technology*, 47 (7– 8), 227–232.
- Spelman D. and Sansalone J. (2018). “Is the Treatment Response of Manufactured BMPs to Urban Drainage PM Loads Portable.” *ASCE Journal of Environmental Engineering*, 144(4): 04018013.
- Smirnov, N. V. (1939). “On the estimation of the discrepancy between empirical curves of distribution for two independent samples.” *Bull. Math. Univ. Moscow*, 2(2), 3-14.

- Taylor, G. D., Fletcher, T. D., Wong, T. H. F., Breen, P. F., and Duncan, H. P. (2005). "Nitrogen Composition in Urban Runoff—Implications for Stormwater Management." *Water Resource*, 39 (10), 1982-1989.
- U.S. Environmental Protection Agency (USEPA). (1993). Handbook of Runoff Pollution, Office of Research and Development, Washington, D.C., p. 6.
- U.S. Environmental Protection Agency (USEPA). (1996). "Environmental indicators of water quality in the United States." Rep. No. EPA- 841R9602, Washington, DC.
- U.S. Environmental Protection Agency (USEPA). (1998). "Toxicity Characteristic Leaching Procedure (Method 1311) Test Methods for Evaluating Solid Wastes, Physical/Chemical Methods (SW-846)." 3rd edition, US Environmental Protection Agency, Washington DC, 1995 (Chapter 9).
- U.S. Environmental Protection Agency (USEPA). (2000a) Progress in water quality: an evaluation of the national investment in municipal wastewater treatment. EPA- 832-R-00-008, Washington, DC, USA
- U.S. Environmental Protection Agency (USEPA). (2000b) Nutrient criteria technical guidance manual. EPA- 822-B-00-002, Washington, DC, USA
- U.S. Environmental Protection Agency (USEPA). (2010) Science and Research at the U.S. Environmental Protection Agency. Washington, DC, USA
- Vaze, J., and Chiew, F. H. S. (2004). "Nutrient loads associated with different sediment sizes in urban stormwater and surface pollutants." *Journal of Environmental Engineering*, 130(4), 391–396.
- Vitousek, P. M., and Howarth, R. W. (1991). "Nitrogen limitation on land and in the sea: How can it occur?" *Biogeochemistry*, 13(2), 87–115.
- Vitousek, P. M., Mooney, H. A., Lubchenco, J., & Melillo, J. M. (1997). "Human domination of earth's ecosystems." *Science*, 277(5325), 494-9.
- T. Wu and J. Sansalone, "Phosphorus Equilibrium II (2013a): Comparing filter media, models, and leaching", *ASCE J. of Environmental Engineering*, 139(11).
- T. Wu and J. Sansalone (2013b), "Mass transfer kinetics of phosphorus to filter media from wastewater stormwater and surrogate matrices", *ASCE J. of Environmental Engineering*, 139(1).
- Wagner, C., and Løkke, H. (1991). "Estimation of ecotoxicological protection levels from NOEC toxicity data." *Water Research*, 25(10), 1237-1242.
- Wilcoxon, F. (1945). "Individual comparisons by ranking methods." *Biometrics bulletin*, 1(6), 80-83.
- Zhang, H. and Sansalone, J. (2014). "Partitioning and First-Flush of Nitrogen in Rainfall-Runoff from an Urban Source Area." *Journal of Environmental Engineering*, 140(8).

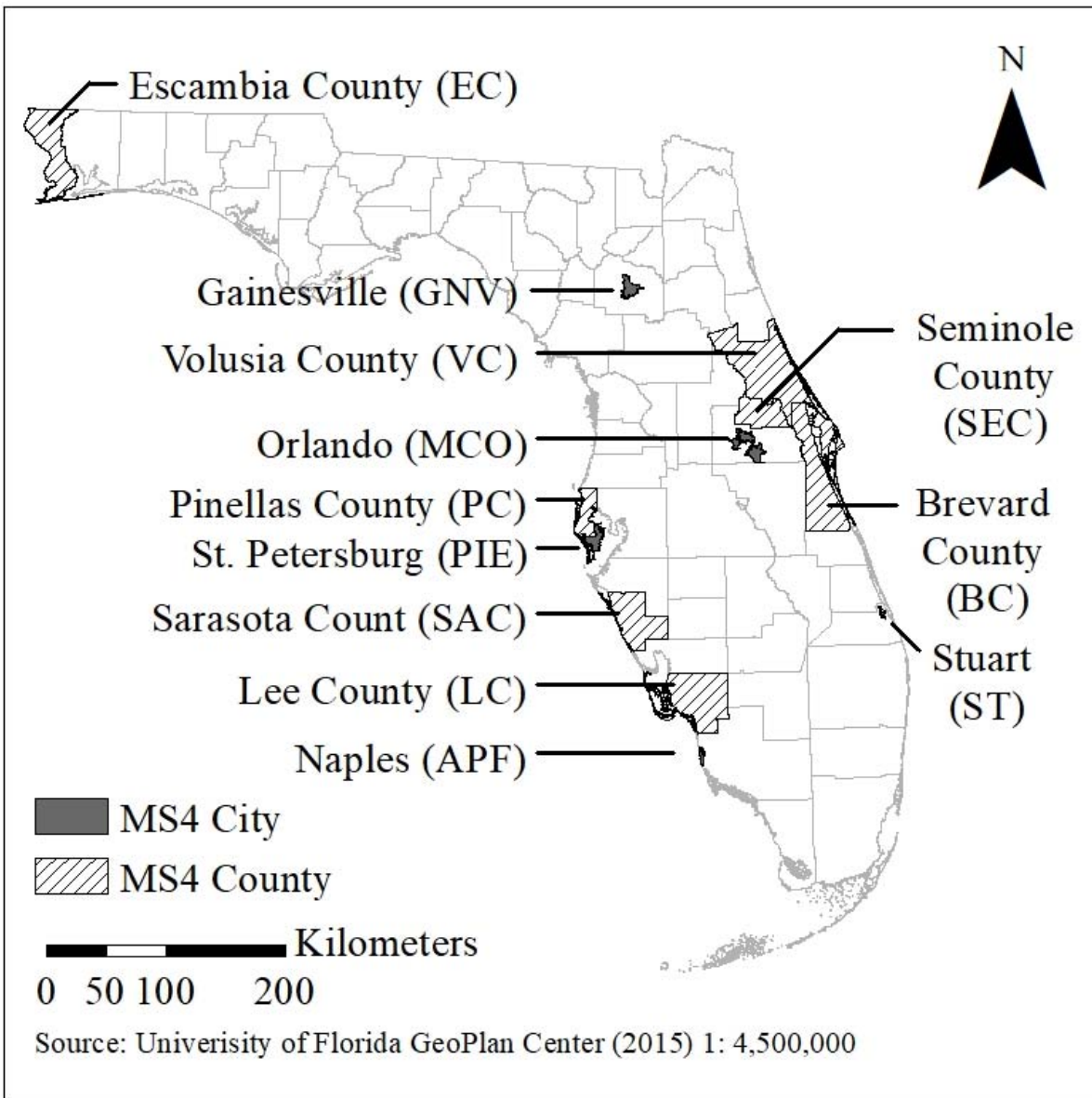

Figure 1 Statewide distribution of MS4 sampling locations.

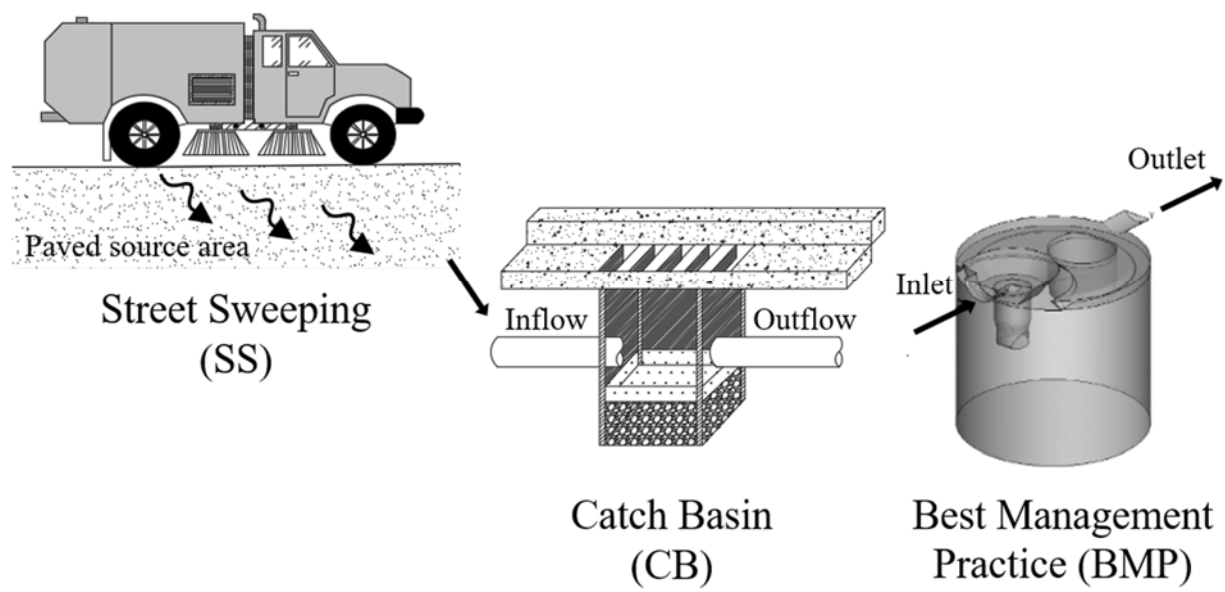

Figure 2 Conceptual illustration of hydrologic functional units (HFUs) sampled in this study.

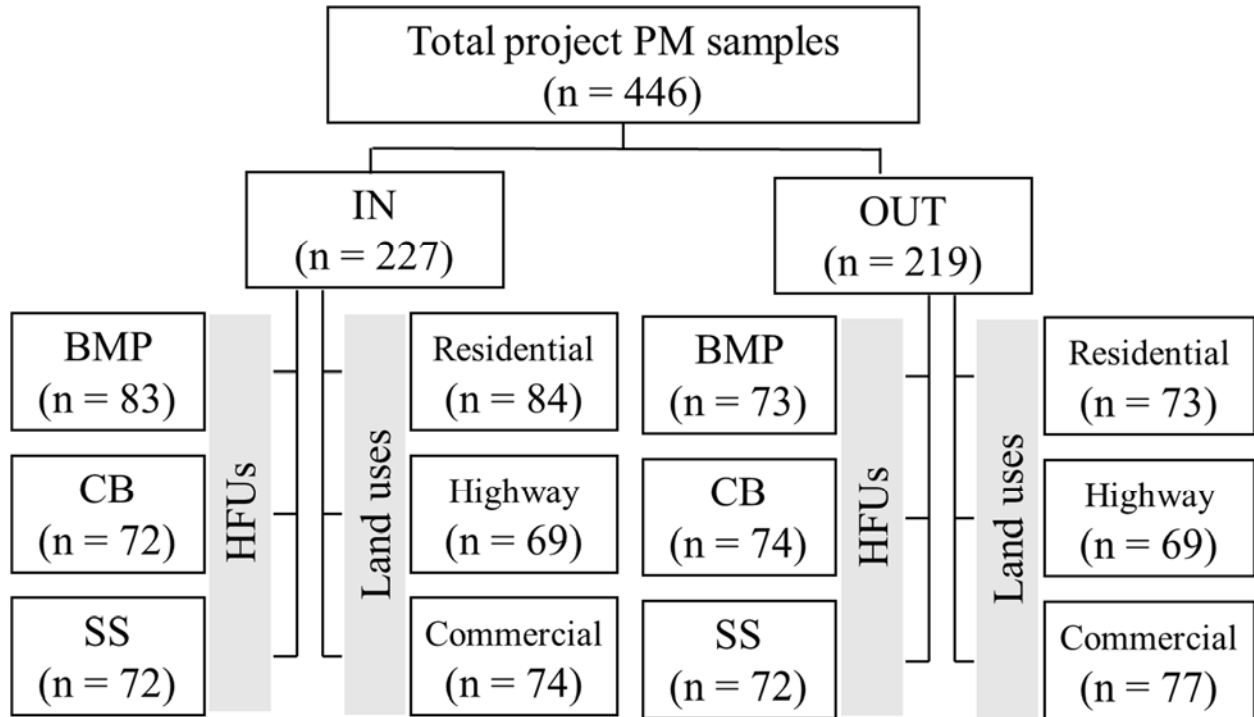

Figure 3 Summary of the final PM sampling matrix and the corresponding PM sample numbers of total project, inside (IN) and outside (OUT) reclaimed water areas, three hydrologic functional units (HFUs) and three land uses. The original total project PM samples for 12 MS4s was n = 432.

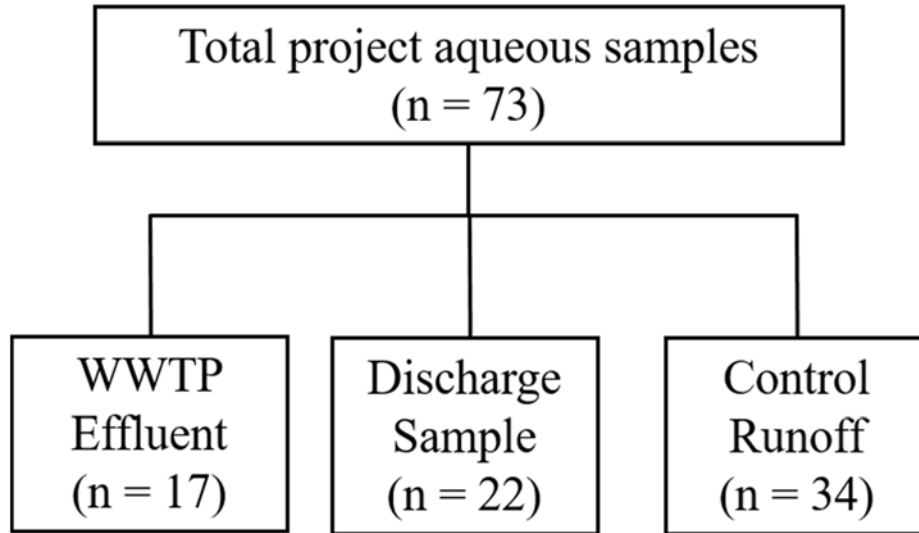

Figure 4 Summary of the final aqueous sampling matrix and the corresponding aqueous sample numbers of total project.



Figure 5 Example of cleaning sampling equipment



Figure 6 Example of collecting PM samples from street sweeping (SS).



Figure 7 Example of collecting PM samples from best practice management (BMP).



Figure 8 Example of sample bottle label.

FIELD INFORMATION - PENSACOLA (ESC-CB-COM-OUT-1)

Sample identification

- ESC-CB-COM-OUT-1

Jurisdiction

- Escambia County

Land use zoning

- Commercial

Location

- 5 Via De Luna Dr.

Co-ordinates

- (30.334726, -87.137285)

Date and time (with previous dry hours)

- 11/29/2017 11:12

- pdh ~ 72

Sampling personnel

- Matt Kelly, Ryan Cummins

Description of Catchment

Cover information

- 50% Asphalt, 50% gravel parking lot

Potential constraints to property access

- Commercial

Typical geometry and R/W section

- 1 lane street bordered by building and gravel parking lot

Run-on conditions

- Runoff from asphalt and gravel parking lots

Reclaimed water application

- No

Basic description of soil type

- Corolla-Urban land complex

Drainage appurtenances in the area

- 5 Catchments

Significant features influencing PM, N, P load

- Aeolian transport, saltation

Predominant PM, N, and P sources

- Naturogenic

Description of BMP

Type

- Catch basin

Approximate age

- ~

Previous cleaning activity

-

Condition

- Good, 5 inches of sediment

Condition of PM residuals

- Moist

Dimensions and volume

- 3' x 3' x 4', 36 ft³

Description of flow to BMP

-

Description of sampling method

- Composite grab with ss spoon

Traffic estimate (ADT)

- N/A

Approx. weight of recovered sample

-

Description of sample and COC

- Moist particulate matter

- COC provided on 11.29.2017



ADT : Average Daily traffic

BMP : Best Management Practice

C : Commercial land use

COC : Chain of Custody

ESC : Escambia

N : Nitrogen

OUT : Outside reclaimed water area

P : Phosphorus

pdh : previous dry hours

PM : Particulate Matter

R/W : Right of Way

Figure 9 Example of field information document for one collected PM-sample.

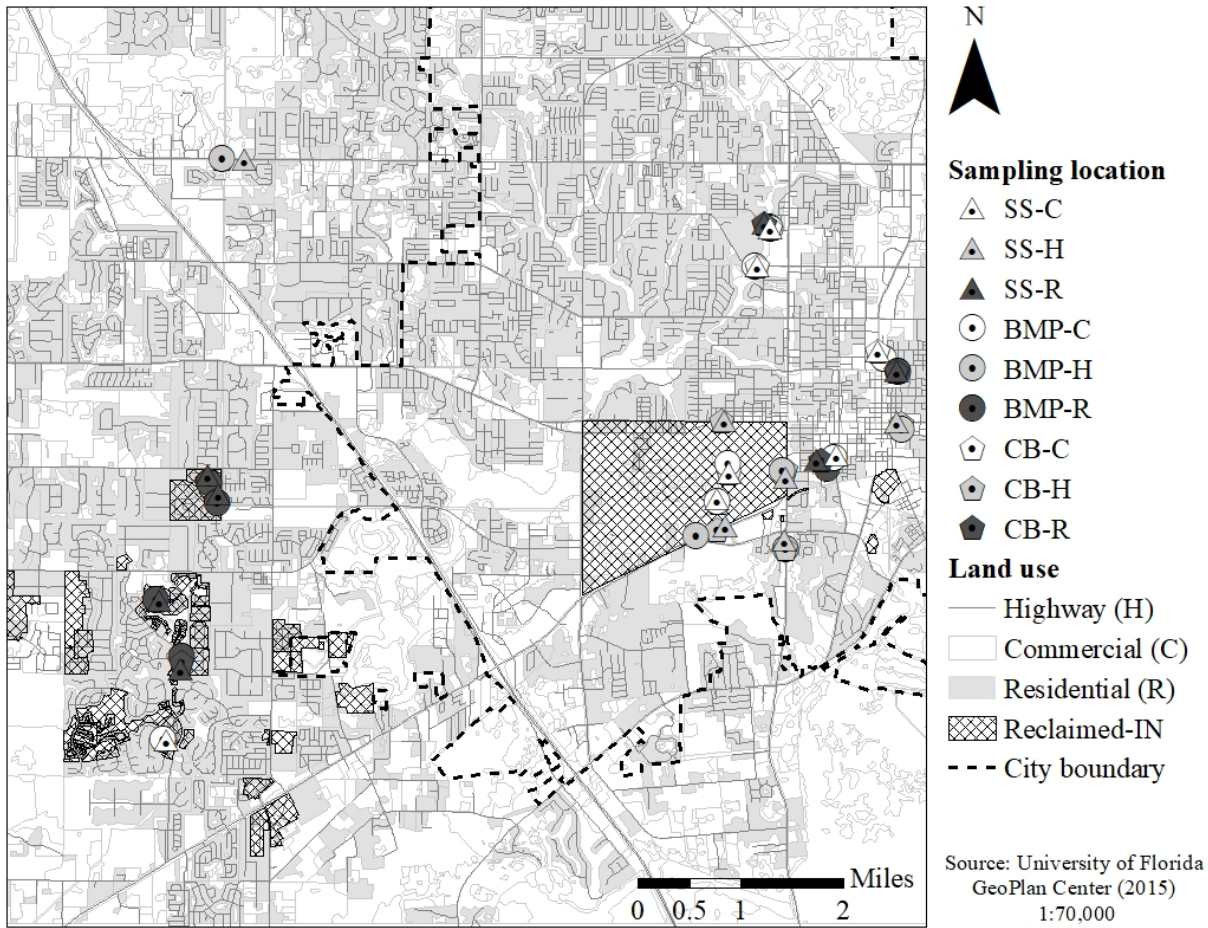
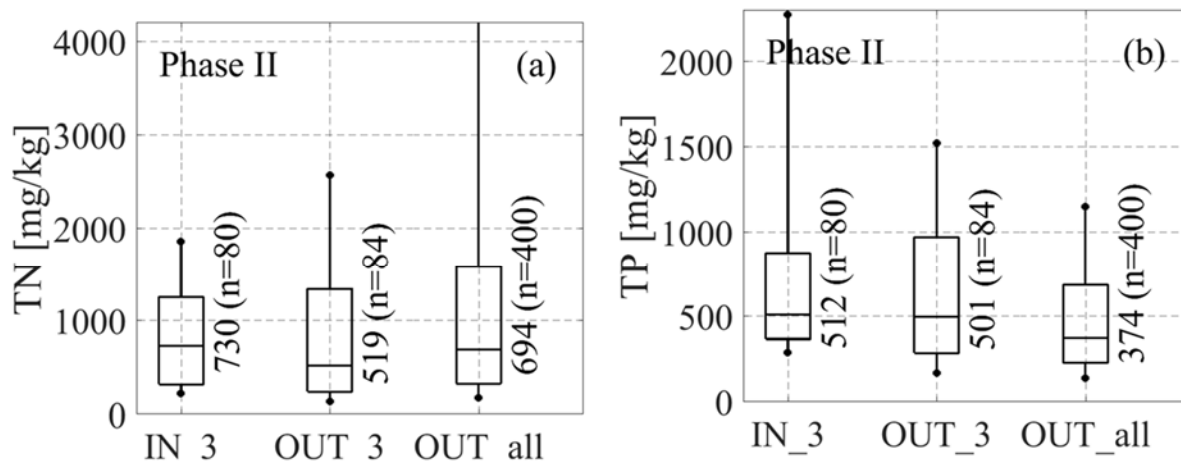

Figure 10 Example of one MS4 (Gainesville) with selected sampling locations, land uses, and reclaimed-IN area presented.



Label	Description	MW test For TN	MW test For TP
IN_3	Reclaimed-IN data from GNV, SAC, TPH		
OUT_3	Reclaimed-OUT data from GNV, SAC, TPH	p = 0.33 IN_3 = OUT_3	p = 0.25 IN_3 = OUT_3
OUT_all	Reclaimed-OUT data from all 14 MS4s	p = 0.68 IN_3 = OUT_all	p = 0.00 IN_3 > OUT_all

Figure 11 Plot (a) and (b) summarizes the non-parametric (assumes no underlying distribution) results from Phase II MS4 PM-based data for inside reclaimed wastewater areas (IN) as compared to outside wastewater areas (OUT) for total nitrogen (TN) and total phosphorus (TP). Median values (μ_{50}) and sample size (n) of each non-parametric are reported. Comparison of the medians of IN and OUT data by the Mann-Whitney U test (MW) are also reported (see Methodology for statistical testing details). The statistical summary table below the plot indicates equivalence between IN and OUT for TN and TP when a paired (IN_3 vs. OUT_3) comparison is made for only GNV, SAC, TPH from Phase II.

Figure 11 extends the comparison of IN and OUT data from Phase II, of which only 3 MS4s (GNV, SAC, TPH) had IN samples while 14 MS4s had OUT samples. If the comparison is paired between IN and OUT for only these 3 MS4s, the above results yields no significant difference by MW test. However, if the comparison is between IN (3 MS4s) and OUT (all 14 MS4s, denoted as OUT_all), TP from reclaimed-IN area is statistically significantly higher than OUT area. In contrast, there is no significant difference for TN. The Phase II report used the second comparison (all 14 MS4s). For consistency using a paired comparison methodology as is carried out with the Phase III report the result based on paired datasets (IN_3 vs. OUT_3) yields no statistical difference between IN and OUT for either TN or TP is consistent with Phase III. See Figure 46 for an alternate examination.

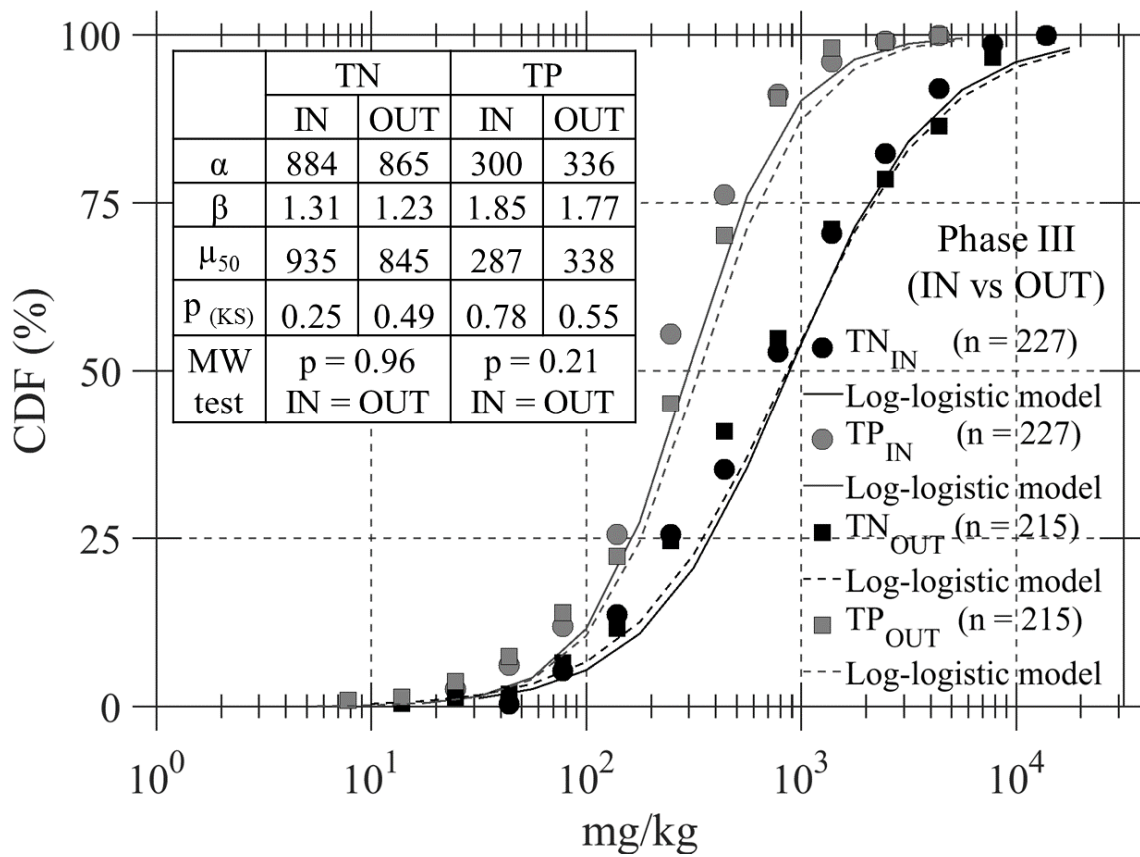

Figure 12 Cumulative distribution function (CDF) of Phase III MS4 data from reclaimed IN and OUT area for total nitrogen and phosphorus. Median values (μ_{50}) are reported. Kolmogorov–Smirnov test ($p > 0.05$) indicates data fit log-logistic distribution with parameters α and β within 95% confidence intervals. Parameters α is a model index for the model median (central tendency) and β is a model index for the model scale (range of concentrations). The symbols represent histogram equivalents of the measured data. Comparison of the medians of IN and OUT data by Mann-Whitney U test (MW) are also reported (see Methodology for statistical testing details).

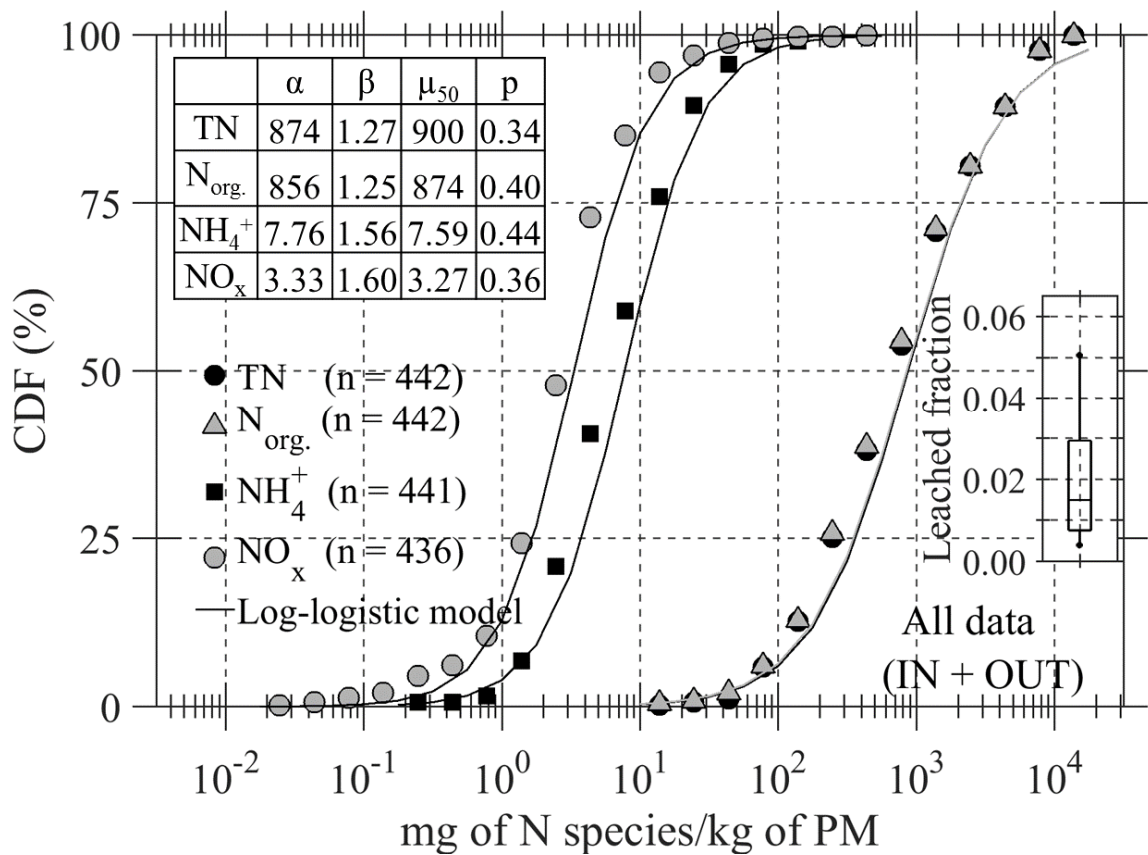

Figure 13 Cumulative distribution function (CDF) of all lumped MS4 data (IN and OUT) for total, organic and leached nitrogen. Median values (μ_{50}) are reported. Kolmogorov–Smirnov test ($p > 0.05$) indicates data fit log-logistic distribution with parameters α and β within 95% confidence intervals. Parameters α is a model index for the model median (central tendency) and β is a model index for the model scale (range of concentrations). The symbols represent histogram equivalents of the measured data. The box plot summarizes the median, upper and lower quartiles for the leached fraction which is the ratio of leached nitrogen (NO_x and NH_4^+) to TN. Small differences in sample number (n) are due to selected samples provided without sufficient mass.

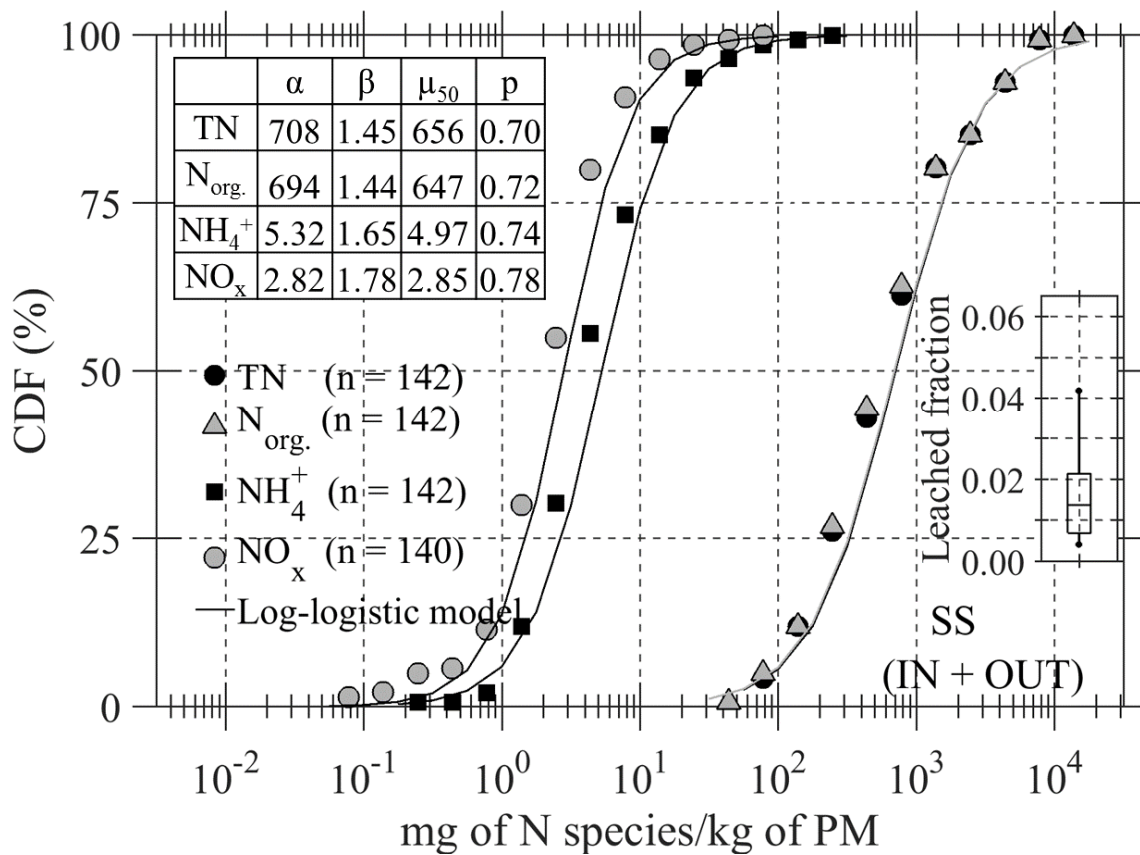

Figure 14 Cumulative distribution function (CDF) of all lumped MS4 data (IN and OUT) by street sweeping (SS) for total, organic and leached nitrogen. Median values (μ_{50}) are reported. Kolmogorov–Smirnov test ($p > 0.05$) indicates data fit log-logistic distribution with parameters α and β within 95% confidence intervals. Parameters α is a model index for the model median (central tendency) and β is a model index for the model scale (range of concentrations). The symbols represent histogram equivalents of the measured data. Box plot summarized the median, upper and lower quartiles for leached fraction which is the ratio of leached nitrogen (NO_x and NH_4^+) to TN. Small differences in sample number (n) are due to selected samples provided without sufficient mass.

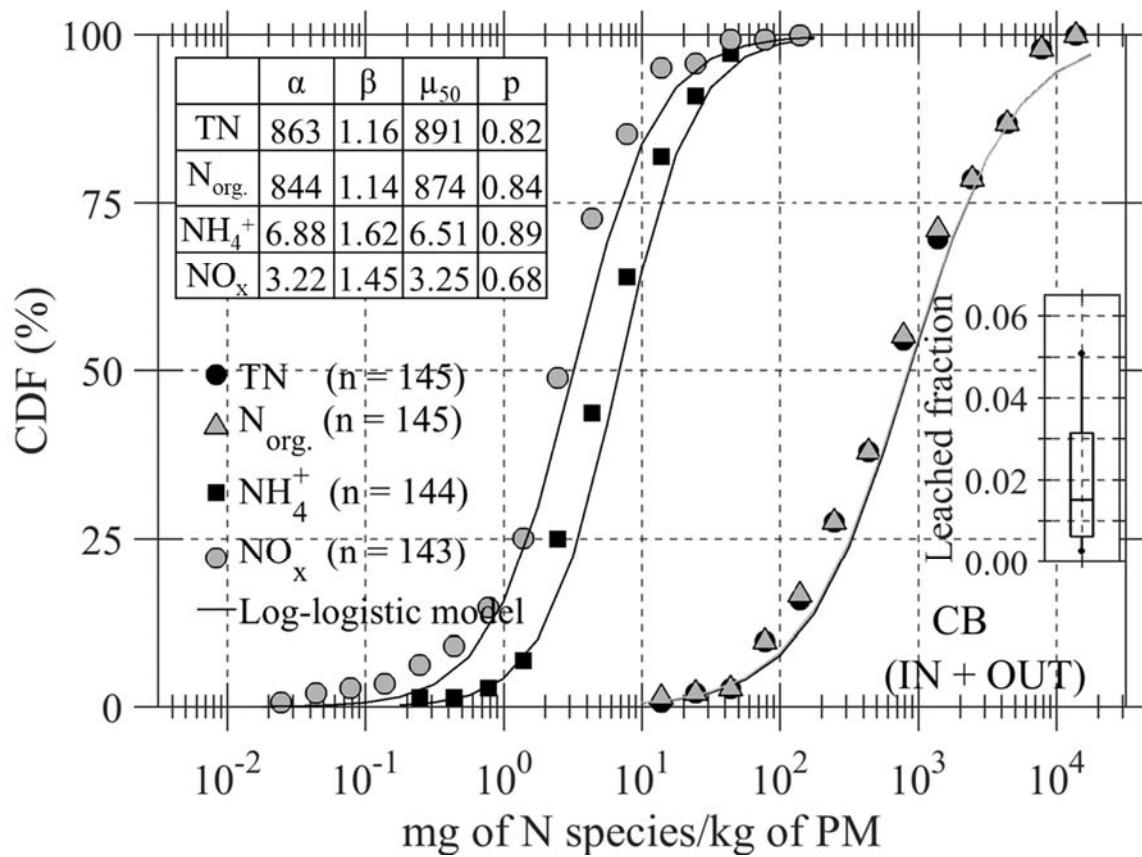

Figure 15 Cumulative distribution function (CDF) of all lumped MS4 data (IN and OUT) by catch basin (CB) for total, organic and leached nitrogen. Median values (μ_{50}) are reported. Kolmogorov–Smirnov test ($p > 0.05$) indicates data fit log-logistic distribution with parameters α and β within 95% confidence intervals. Parameters α is a model index for the model median (central tendency) and β is a model index for the model scale (range of concentrations). The symbols represent histogram equivalents of the measured data. Box plot summarized the median, upper and lower quartiles for leached fraction which is the ratio of leached nitrogen (NO_x and NH_4^+) to TN. Small differences in sample number (n) are due to selected samples provided without sufficient mass.

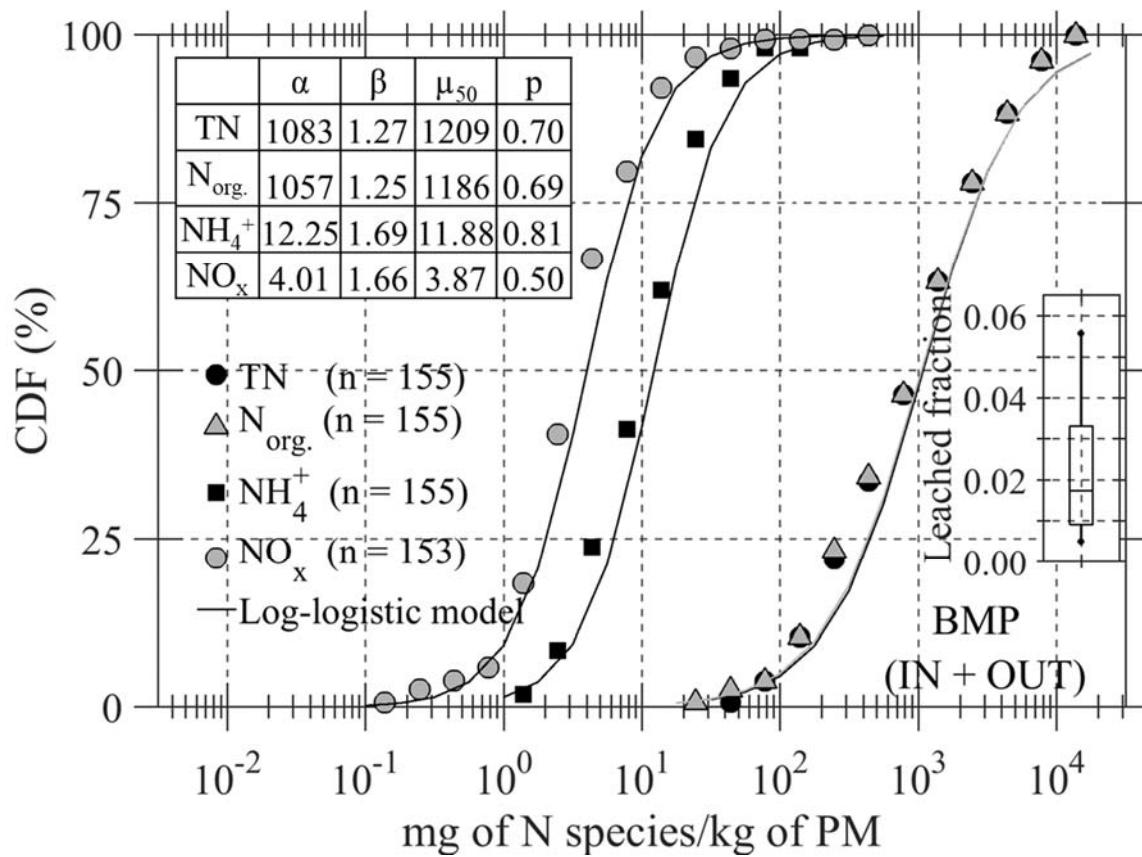

Figure 16 Cumulative distribution function (CDF) of all lumped MS4 data (IN and OUT) by best management practice (BMP) for total, organic and leached nitrogen. Median values (μ_{50}) are reported. Kolmogorov–Smirnov test ($p > 0.05$) indicates data fit log-logistic distribution with parameters α and β within 95% confidence intervals. Parameters α is a model index for the model median (central tendency) and β is a model index for the model scale (range of concentrations). The symbols represent histogram equivalents of the measured data. Box plot summarized the median, upper and lower quartiles for leached fraction which is the ratio of leached nitrogen (NO_x and NH_4^+) to TN. Small differences in sample number (n) are due to selected samples provided without sufficient mass.

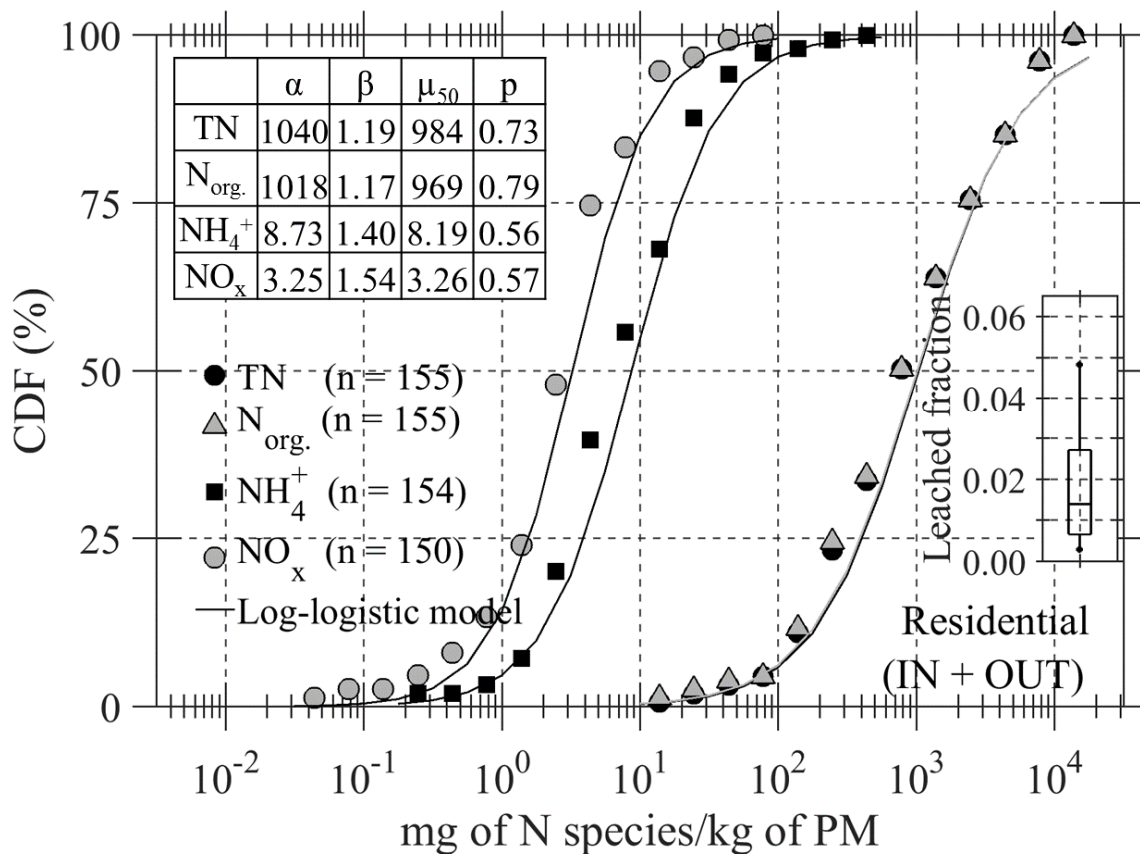

Figure 17 Cumulative distribution function (CDF) of all lumped MS4 data (IN and OUT) by residential land use for total, organic and leached nitrogen. Median values (μ_{50}) are reported. Kolmogorov–Smirnov test ($p > 0.05$) indicates data fit log-logistic distribution with parameters α and β within 95% confidence intervals. Parameters α is a model index for the model median (central tendency) and β is a model index for the model scale (range of concentrations). The symbols represent histogram equivalents of the measured data. Box plot summarized the median, upper and lower quartiles for leached fraction which is the ratio of leached nitrogen (NO_x and NH_4^+) to TN. Small differences in sample number (n) are due to selected samples provided without sufficient mass.

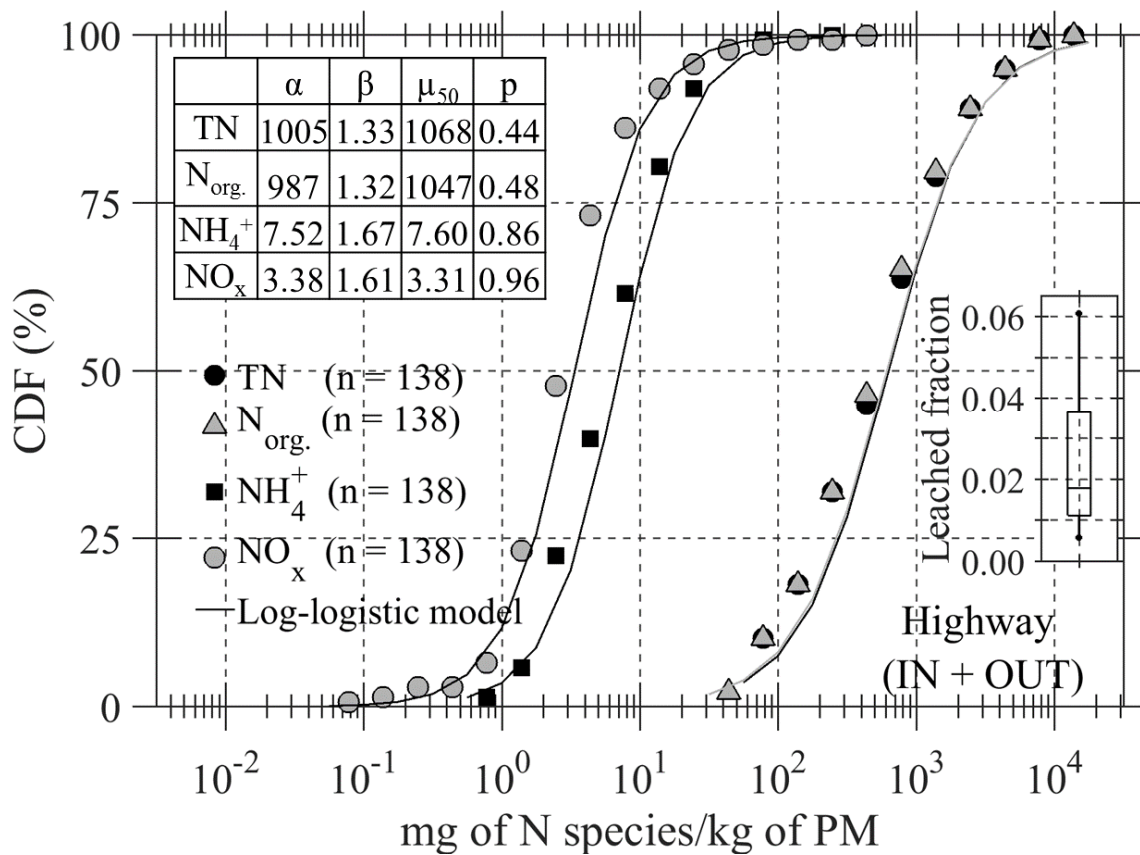

Figure 18 Cumulative distribution function (CDF) of all lumped MS4 data (IN and OUT) by highway land use for total, organic and leached nitrogen. Median values (μ_{50}) are reported. Kolmogorov–Smirnov test ($p > 0.05$) indicates data fit log-logistic distribution with parameters α and β within 95% confidence intervals. Parameters α is a model index for the model median (central tendency) and β is a model index for the model scale (range of concentrations). The symbols represent histogram equivalents of the measured data. Box plot summarized the median, upper and lower quartiles for leached fraction which is the ratio of leached nitrogen (NO_x and NH_4^+) to TN. Small differences in sample number (n) are due to selected samples provided without sufficient mass.

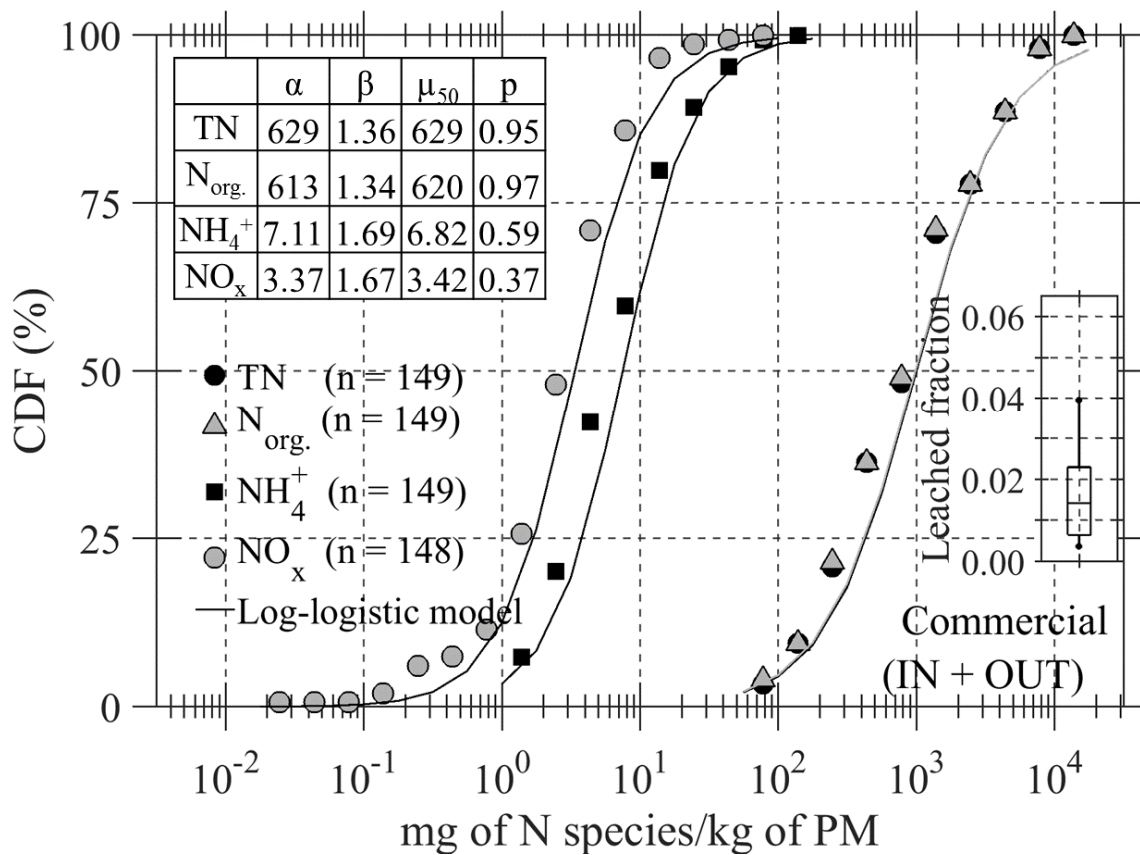
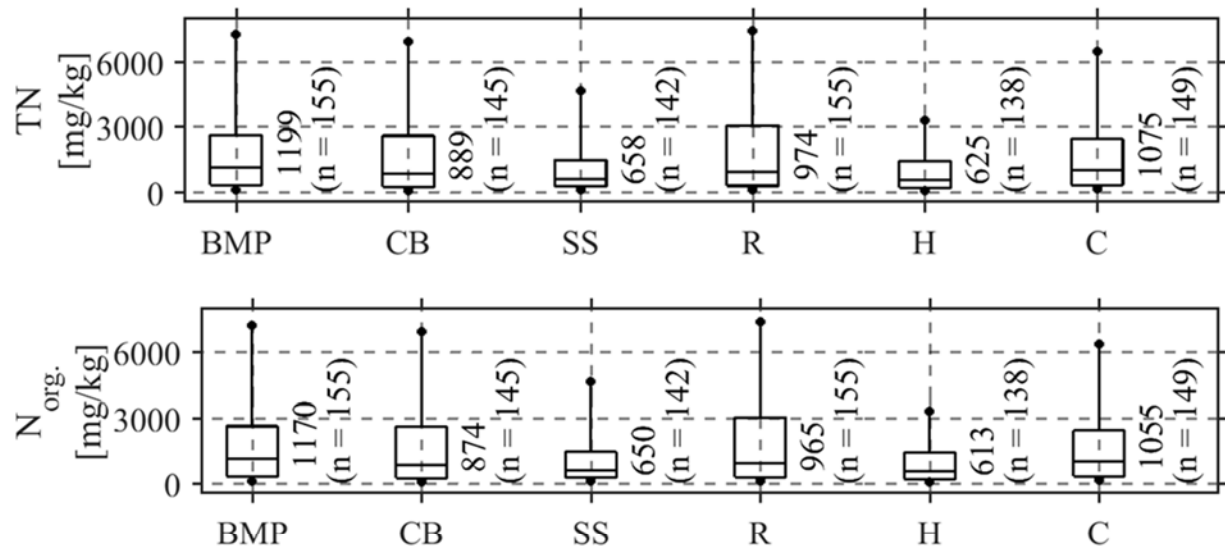
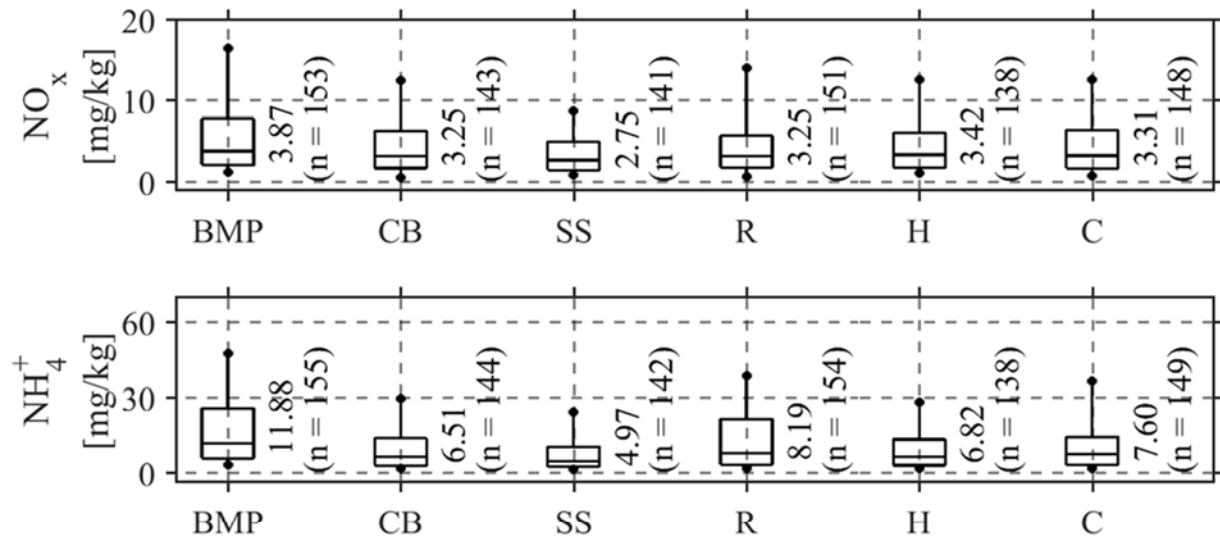

Figure 19 Cumulative distribution function (CDF) of all lumped MS4 data (IN and OUT) by commercial land use for total, organic and leached nitrogen. Median values (μ_{50}) are reported. Kolmogorov–Smirnov test ($p > 0.05$) indicates data fit log-logistic distribution with parameters α and β within 95% confidence intervals. Parameters α is a model index for the model median (central tendency) and β is a model index for the model scale (range of concentrations). The symbols represent histogram equivalents of the measured data. Box plot summarized the median, upper and lower quartiles for leached fraction which is the ratio of leached nitrogen (NO_x and NH_4^+) to TN. Small differences in sample number (n) are due to selected samples provided without sufficient mass.



MW test	BMP vs CB	CB vs SS	BMP vs SS	R vs H	H vs C	R vs C
TN	p = 0.20 BMP = CB	p = 0.28 CB = SS	p = 0.01 SS < BMP	p = 0.00 R > H	p = 0.00 H < C	p = 0.86 C = R
N _{org}	p = 0.21 BMP = CB	p = 0.28 CB = SS	p = 0.01 SS < BMP	p = 0.00 R > H	p = 0.00 H < C	p = 0.86 C = R

Figure 20 Non-parametric (assumes no underlying distribution) plots of all lumped MS4 data (IN and OUT) by hydrologic function units (HFUs) and land uses for total and organic nitrogen. Median and sample size (n) and of each plot are reported. Comparison of the medians of two groups by Mann-Whitney U test (MW) are also reported (see statistical analysis for details).



MW test	BMP vs CB	CB vs SS	BMP vs SS	R vs H	H vs C	R vs C
NO_x	p = 0.07 BMP \geq CB	p = 0.20 CB = SS	p = 0.00 SS < BMP	p = 0.71 R = H	p = 0.95 H = C	p = 0.70 C = R
NH_4^+	p = 0.00 BMP > CB	p = 0.04 CB > SS	p = 0.00 SS < BMP	p = 0.15 R = H	p = 0.67 H = C	p = 0.32 C = R

Figure 21 Box plots of all lumped MS4 data (IN and OUT) by hydrologic function units (HFUs) and land uses for leached nitrogen (NO_x and NH_4^+). Median and sample size (n) and of each plot are reported. Comparison of the medians of two groups by Mann-Whitney U test (MW) are also reported.

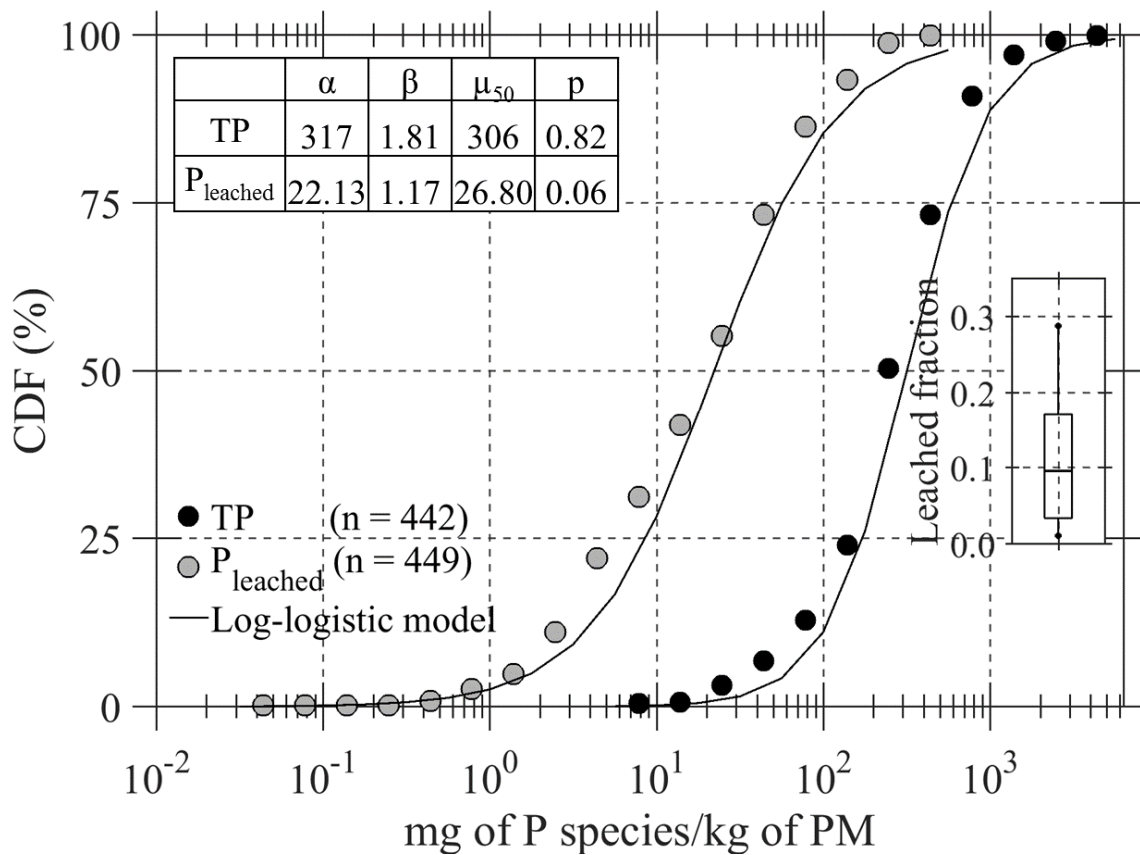

Figure 22 Cumulative distribution function (CDF) of all lumped MS4 data (IN and OUT) for total and leached phosphorus. Median values (μ_{50}) are reported. Kolmogorov–Smirnov test ($p > 0.05$) indicates data fit log-logistic distribution with parameters α and β within 95% confidence intervals. Parameters α is a model index for the model median (central tendency) and β is a model index for the model scale (range of concentrations). The symbols represent histogram equivalents of the measured data. Box plot summarized the median, upper and lower quartiles for leached fraction which is the ratio of leached phosphorus to TP. Small differences in sample number (n) are due to selected samples provided without sufficient mass.

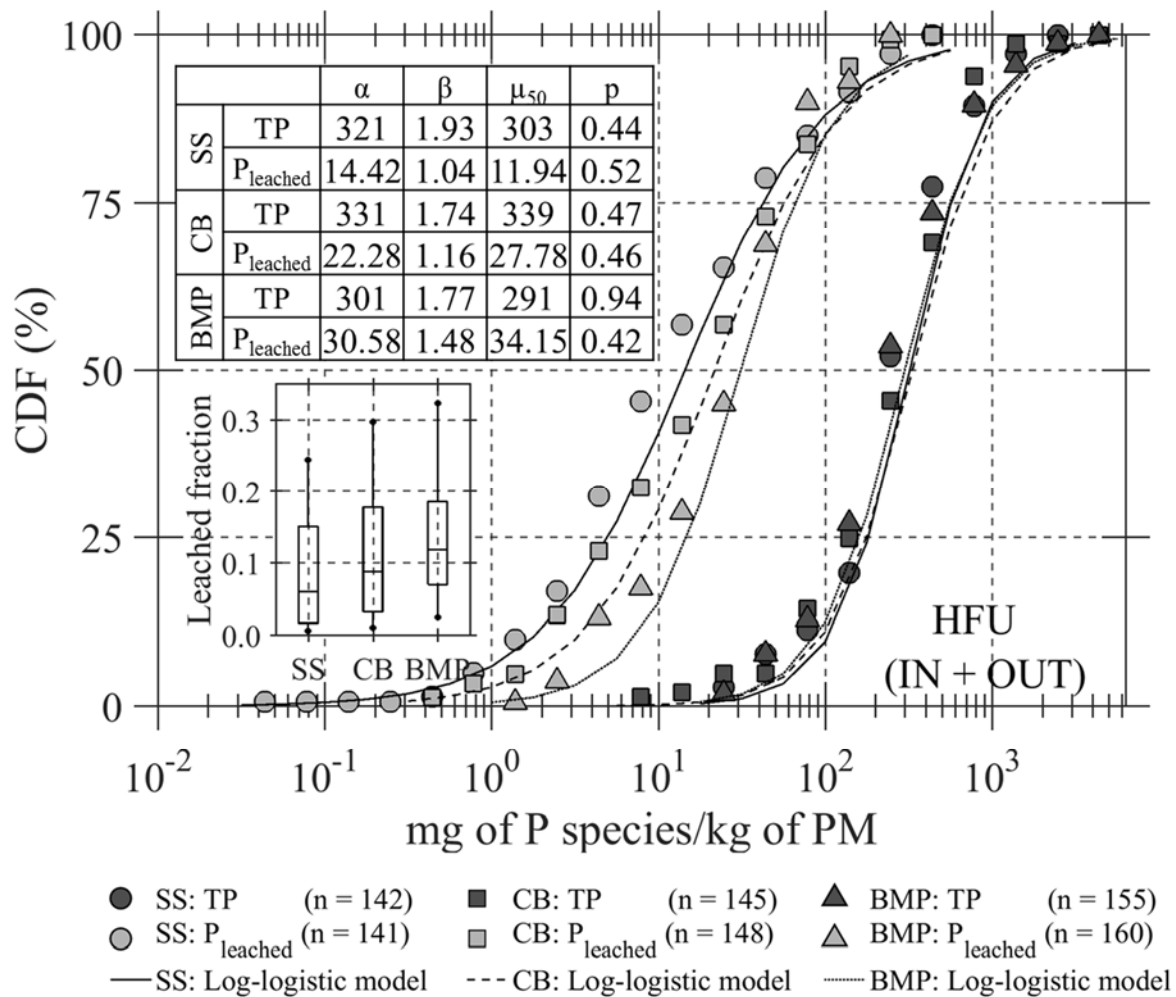

Figure 23 Cumulative distribution function (CDF) of all lumped MS4 data by hydrologic function units for total and leached phosphorus. Median values (μ_{50}) are reported. Kolmogorov-Smirnov test ($p > 0.05$) indicates data fit log-logistic distribution with parameters α and β within 95% confidence intervals. Parameters α is a model index for the model median (central tendency) and β is a model index for the model scale (range of concentrations). The symbols represent histogram equivalents of the measured data. Box plot summarized the median, upper and lower quartiles for leached fraction which is the ratio of leached phosphorus to TP. Small differences in sample number (n) are due to selected samples provided without sufficient mass.

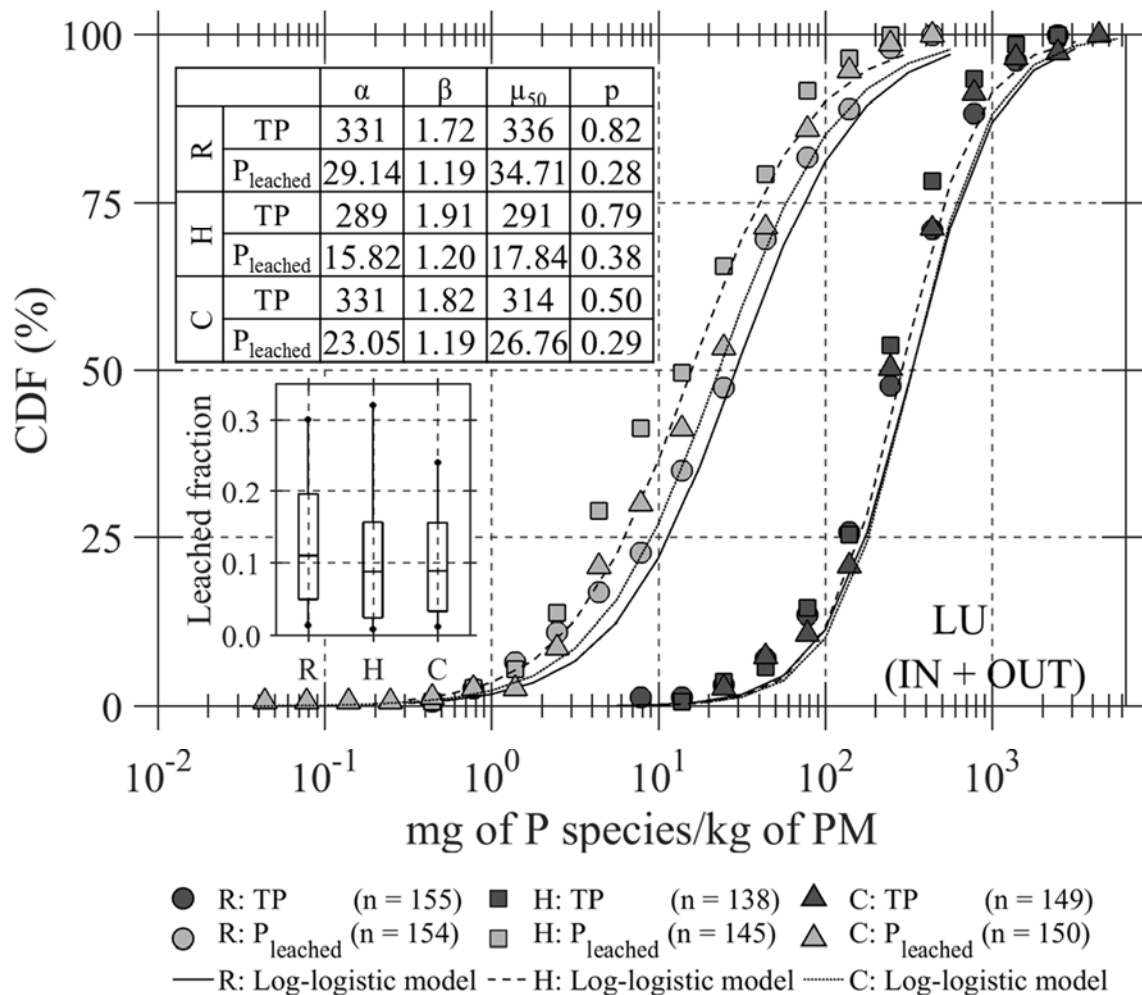
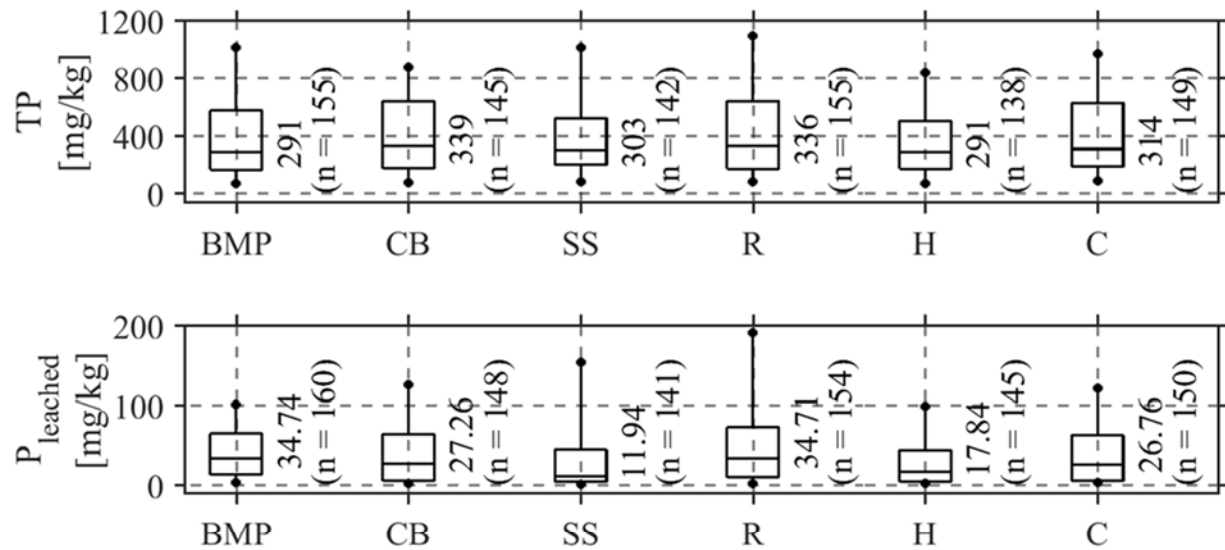

Figure 24 Cumulative distribution function (CDF) of all lumped MS4 data (IN and OUT) by land uses for total and leached phosphorus. Median values (μ_{50}) are reported. Kolmogorov–Smirnov test ($p > 0.05$) indicates data fit log-logistic distribution with parameters α and β within 95% confidence intervals. Parameters α is a model index for the model median (central tendency) and β is a model index for the model scale (range of concentrations). The symbols represent histogram equivalents of the measured data. Box plot summarized the median, upper and lower quartiles for leached fraction which is the ratio of leached phosphorus to TP. Small differences in sample number (n) are due to selected samples provided without sufficient mass.



MW test	BMP vs CB	CB vs SS	BMP vs SS	R vs H	H vs C	R vs C
TP	p = 0.43 BMP = CB	p = 0.63 CB = SS	p = 0.52 SS = BMP	p = 0.20 R = H	p = 0.23 H = C	p = 0.97 C = R
P _{leached}	p = 0.09 BMP ≥ CB	p = 0.05 CB ≥ SS	p = 0.00 SS < BMP	p = 0.00 R > H	p = 0.03 H < C	p = 0.24 C = R

Figure 25 Box plots of all lumped MS4 data (IN and OUT) by hydrologic function units (HFUs) and land uses for total and leached phosphorus. Median and sample size (n) and of each plot are reported. Comparison of the medians of two groups by Mann-Whitney U test (MW) are also reported.

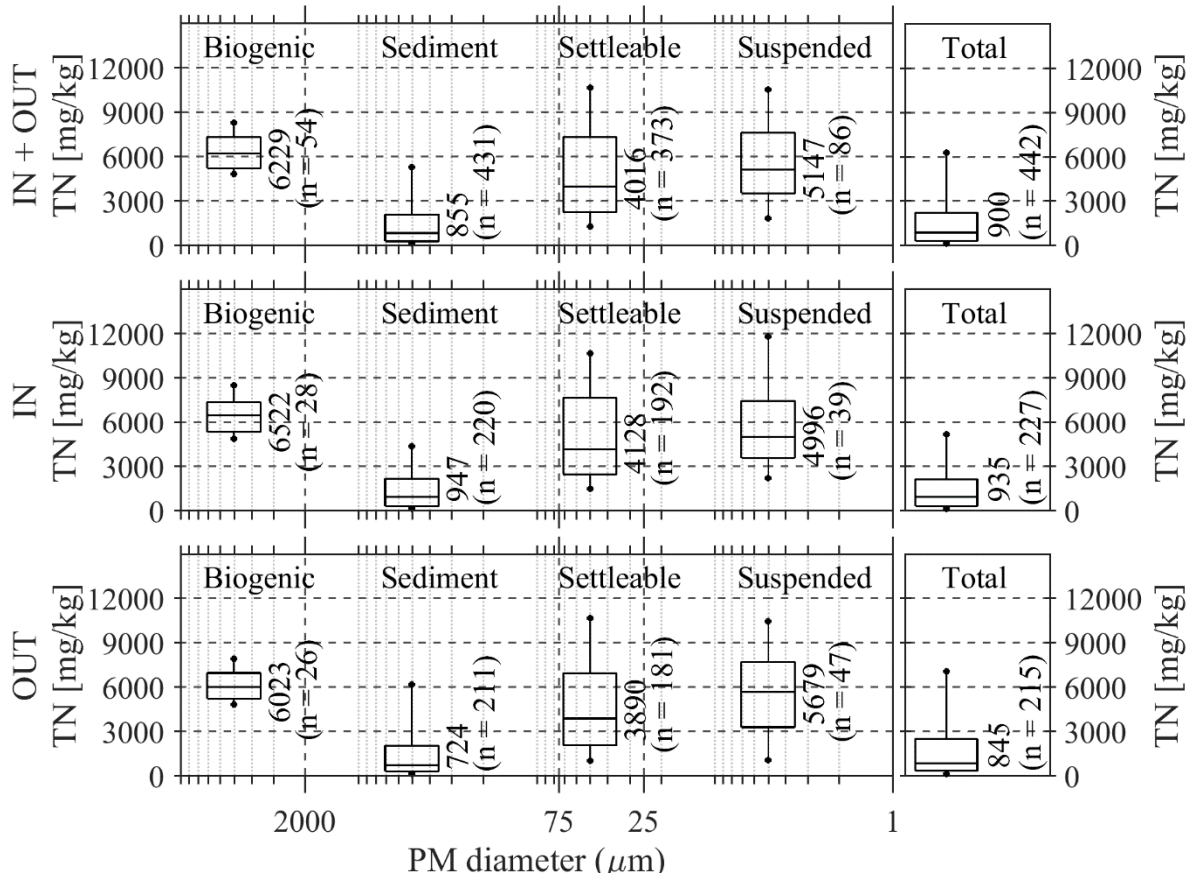

Figure 26 Box plots of all lumped and then separated MS4 data from reclaimed IN and OUT area for total nitrogen (TN) across total and each PM fraction. Biogenic matter is selected from PM with diameters greater than 2000 μm . For all results, sediment is a PM fraction with diameters between 75 and 2000 μm (by definition and separated before the Imhoff Cone procedure). Settleable is PM with diameters between 25 and 75 μm . Suspended is PM with diameters under 25 μm . For all results reported as operational PM size classes or fractions, settleable and suspended PM are operational separated at one hour of quiescent settling in an Imhoff Cone. Median and sample size (n) and of each plot are reported.

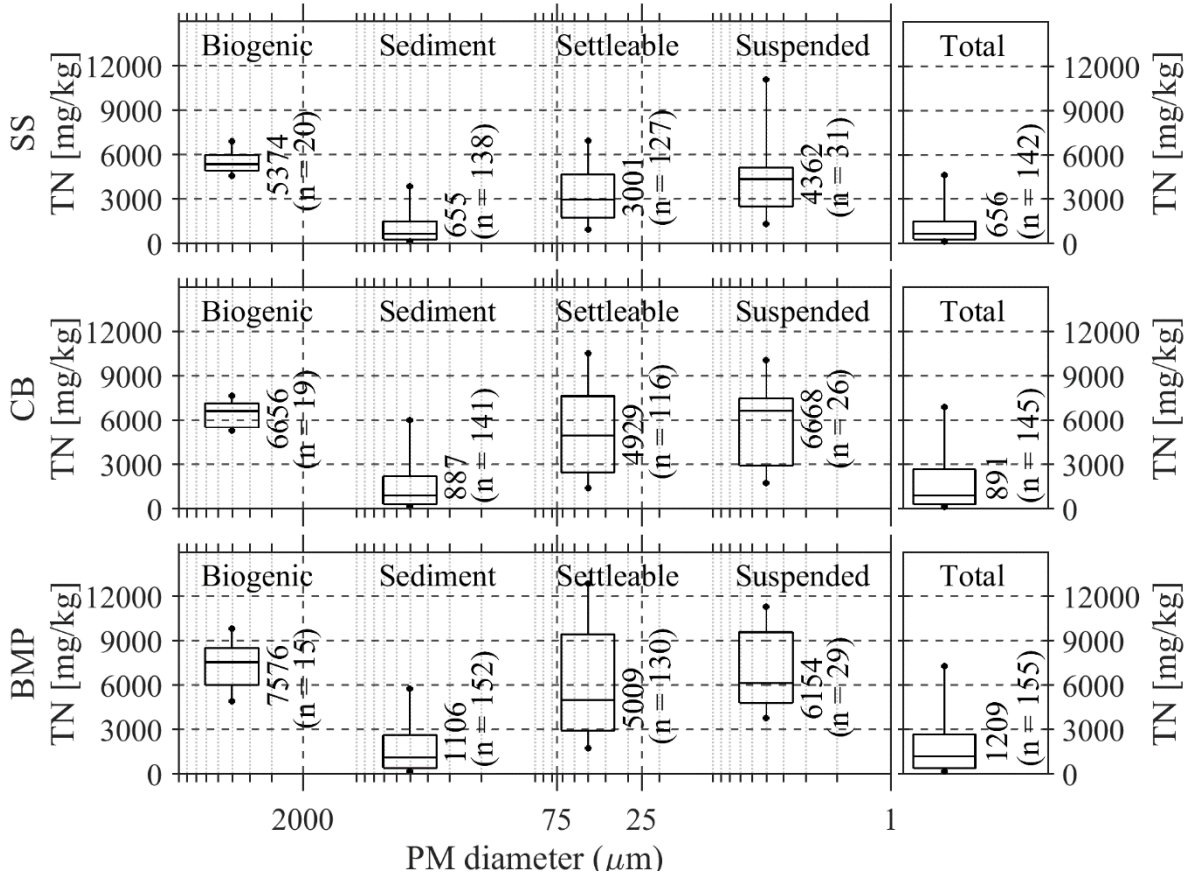

Figure 27 Box plots of all lumped MS4 data (IN and OUT) by hydrologic functional units (HFUs) for total nitrogen (TN) across total and each PM fraction. Biogenic matter is selected from PM with diameters greater than 2000 μm . Sediment is PM with diameters between 75 and 2000 μm . Settleable is PM with diameters between 25 and 75 μm . Suspended is PM with diameters under 25 μm . Median and sample size (n) and of each plot are reported.

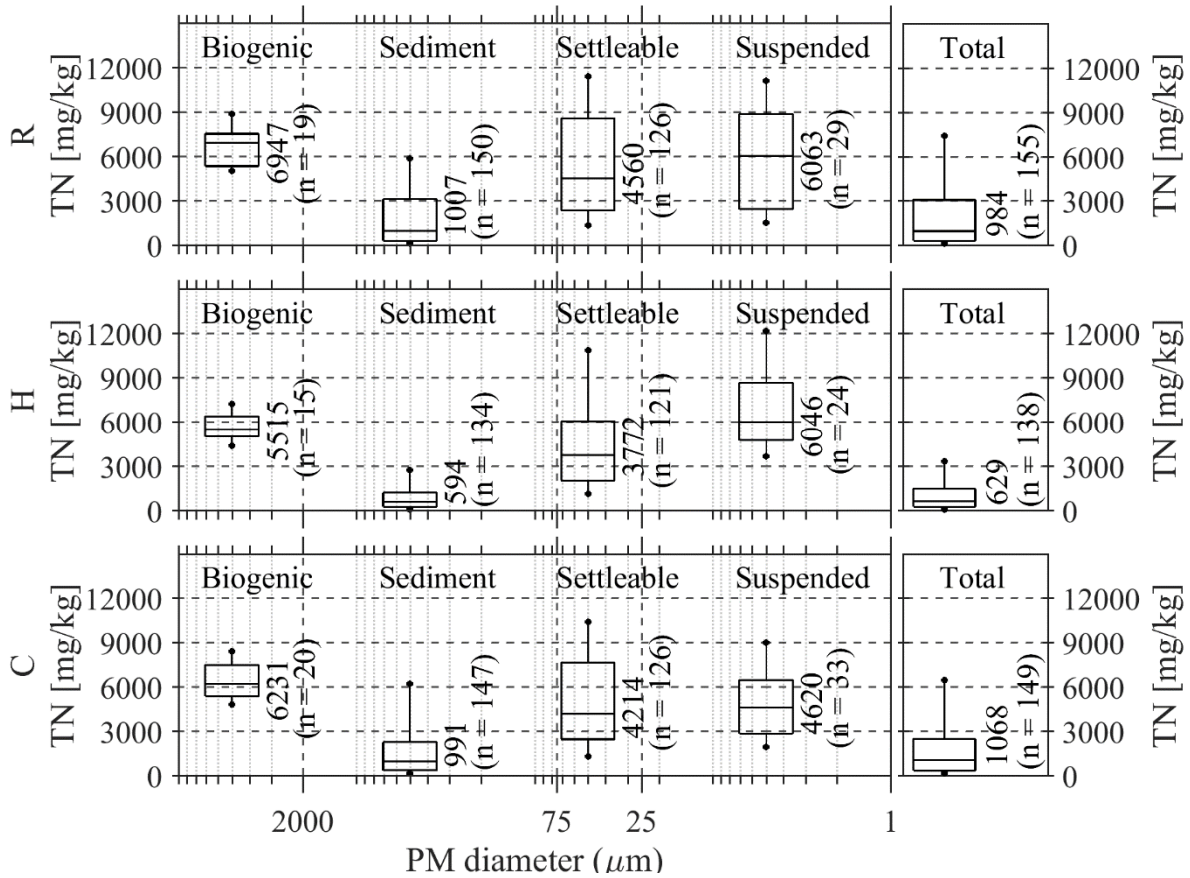

Figure 28 Box plots of all lumped MS4 data (IN and OUT) by land uses for total nitrogen (TN) across total and each PM fraction. Biogenic matter is selected from PM with diameters greater than 2000 μm . Sediment is PM with diameters between 75 and 2000 μm . Settleable PM with diameter between 25 and 75 μm . Suspended is PM with diameters under 25 μm . Median and sample size (n) and of each plot are reported.

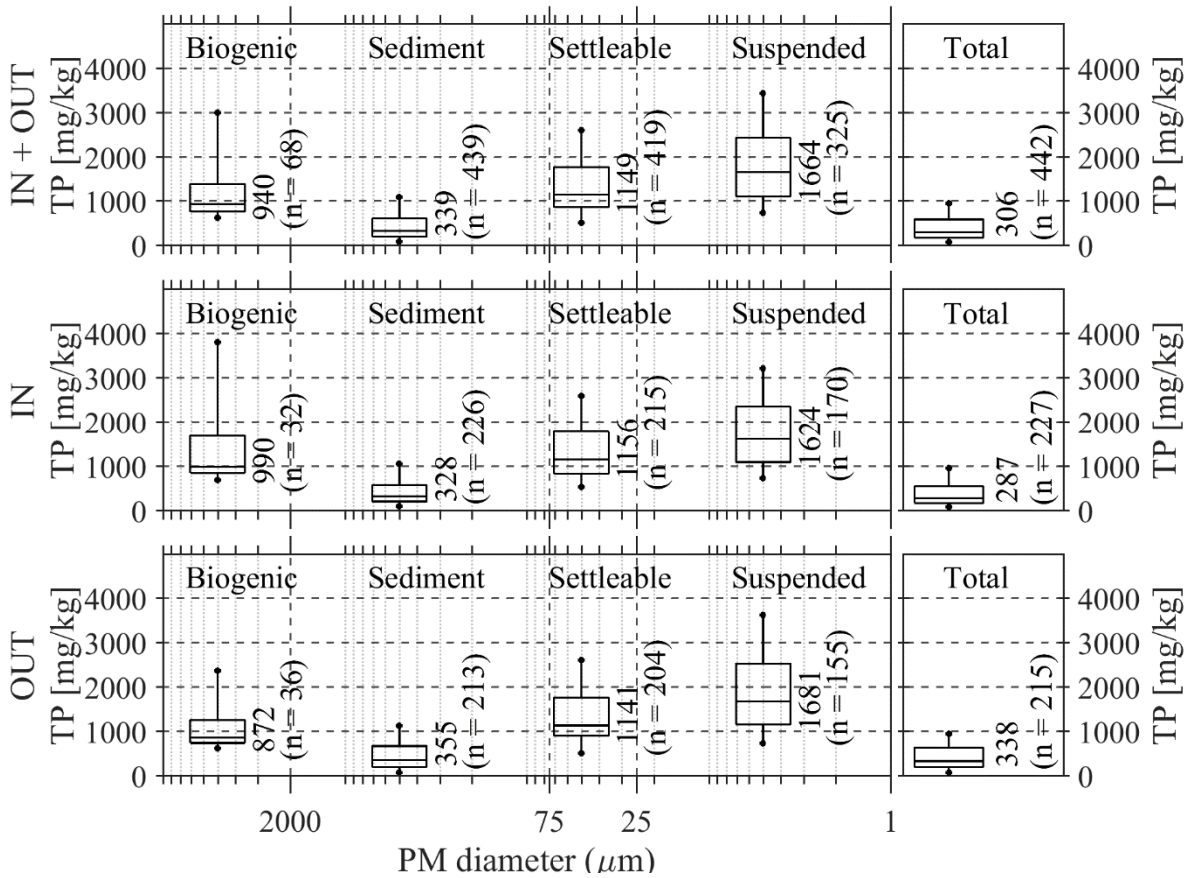

Figure 29 Box plots of all lumped and then separated MS4 data from reclaimed IN and OUT area for total phosphorus (TP) across total and each PM fraction. Biogenic matter is selected from PM with diameters greater than 2000 μm . Sediment is PM with diameters between 75 and 2000 μm . Settleable is PM with diameters between 25 and 75 μm . Suspended is PM with diameters under 25 μm . Median and sample size (n) and of each plot are reported.

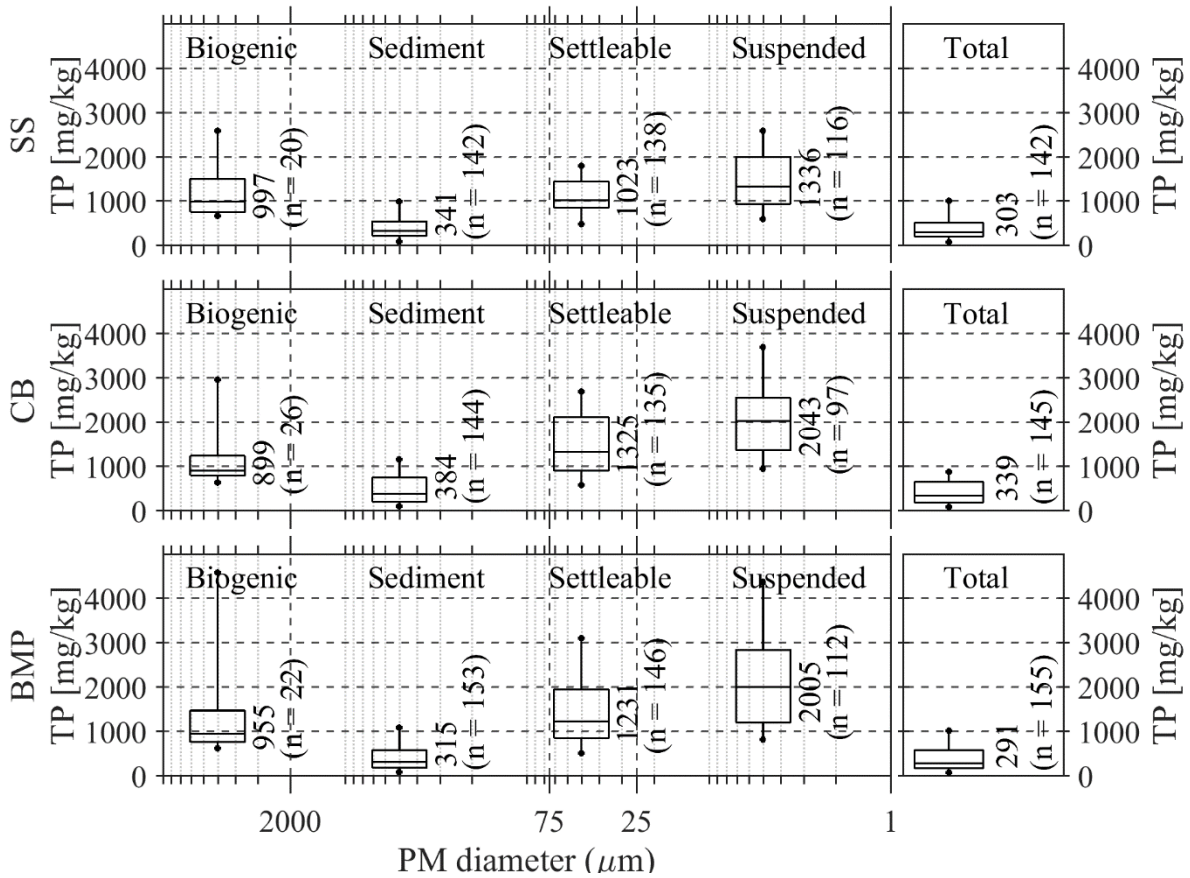

Figure 30 Box plots of all lumped MS4 data (IN and OUT) by hydrologic functional units (HFUs) for total phosphorus (TP) across total and each PM fraction. Biogenic matter is selected from PM with diameters greater than 2000 μm . Sediment is PM with diameters between 75 and 2000 μm . Settleable is PM with diameters between 25 and 75 μm . Suspended is PM with diameters under 25 μm . Median and sample size (n) and of each plot are reported.

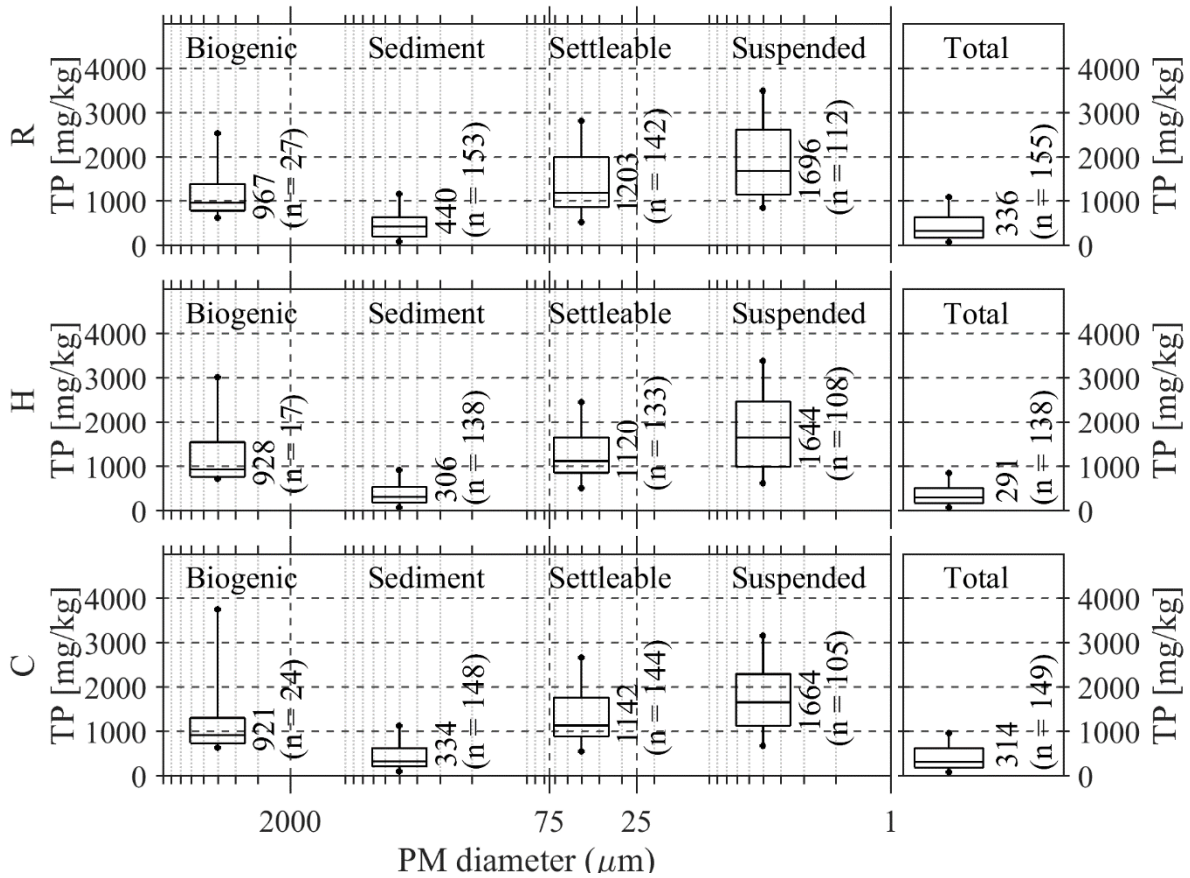

Figure 31 Box plots of all lumped MS4 data (IN and OUT) by land uses for total phosphorus (TP) across total and each PM fraction. Biogenic matter is selected from PM with diameters greater than 2000 μm . Sediment is PM with diameters between 75 and 2000 μm . Settleable is PM with diameters between 25 and 75 μm . Suspended is PM with diameters under 25 μm . Median and sample size (n) and of each plot are reported.

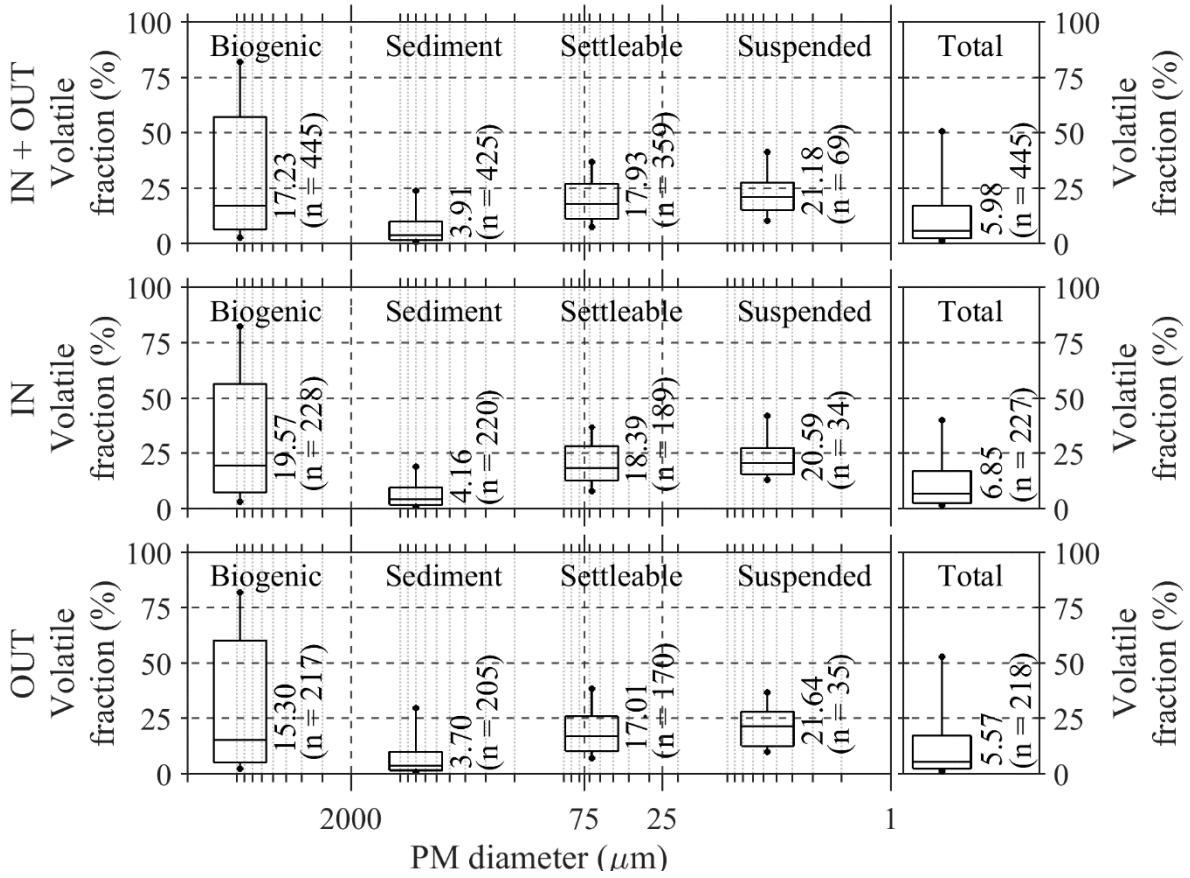

Figure 32 Box plots of all lumped and then separated MS4 data from reclaimed IN and OUT area for volatile fraction (VF) across total and each PM fraction. Biogenic matter is selected from PM with diameters greater than 2000 μm . Sediment is PM with diameters between 75 and 2000 μm . Settleable is PM with diameters between 25 and 75 μm . Suspended is PM with diameters under 25 μm . Median and sample size (n) and of each plot are reported.

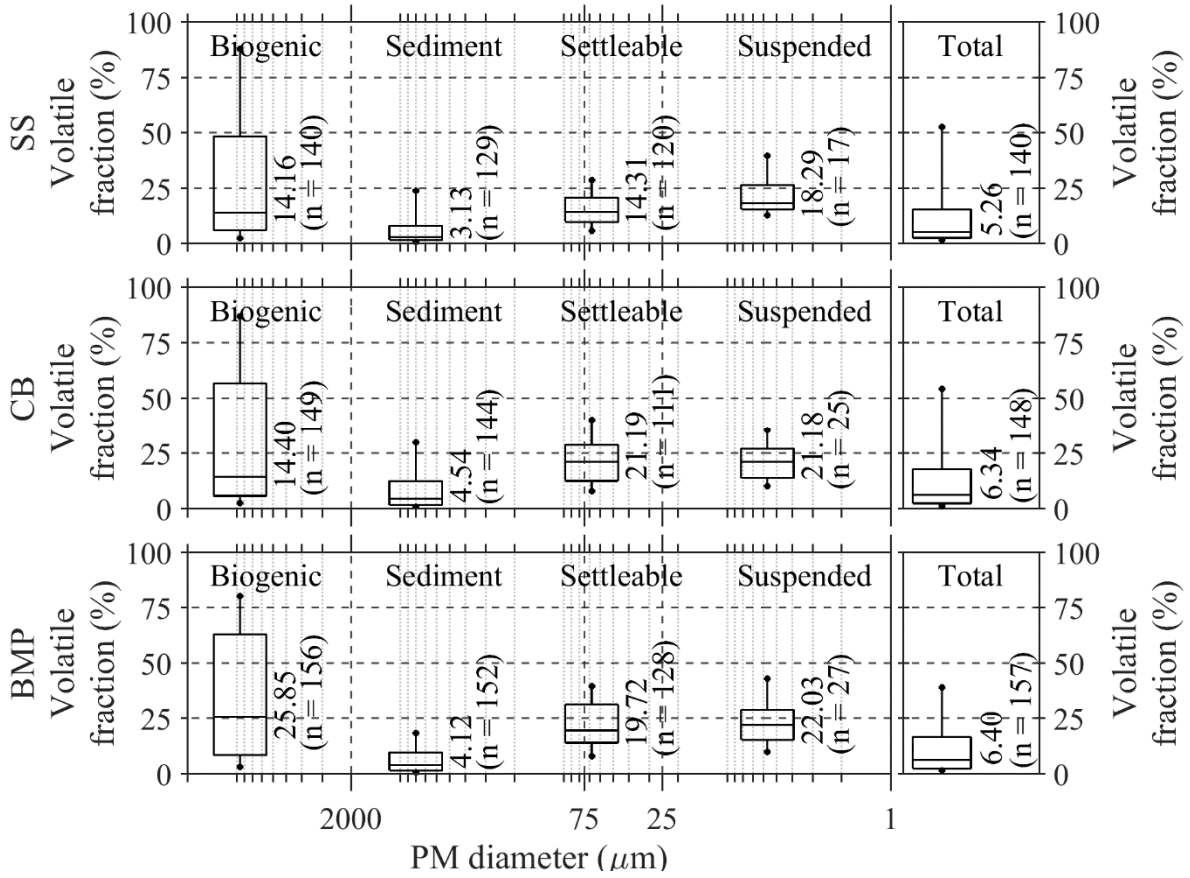

Figure 33 Box plots of all lumped MS4 data (IN and OUT) by hydrologic functional units (HFUs) for volatile fraction (VF) across total and each PM fraction. Biogenic matter is selected from PM with diameter greater than 2000 μm . Sediment is PM with diameter between 75 and 2000 μm . Settleable is PM with diameters between 25 and 75 μm . Suspended is PM with diameters under 25 μm . Median and sample size (n) and of each plot are reported.

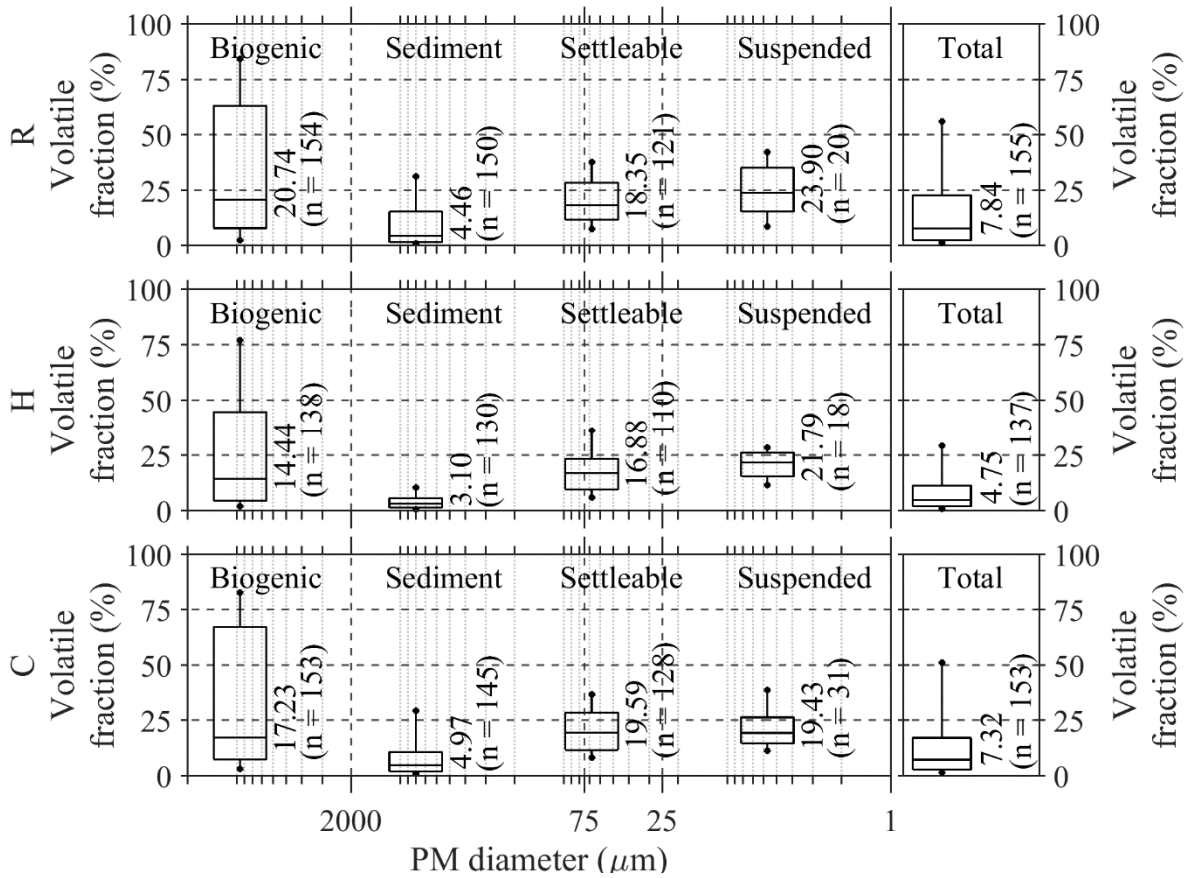

Figure 34 Box plots of all lumped MS4 data (IN and OUT) by land uses for volatile fraction (VF) across total and each PM fraction. Biogenic matter is selected from PM with diameters greater than 2000 μm. Sediment is PM with diameters between 75 and 2000 μm. Settleable is PM with diameters between 25 and 75 μm. Suspended is PM with diameters under 25 μm. Median and sample size (n) and of each plot are reported.

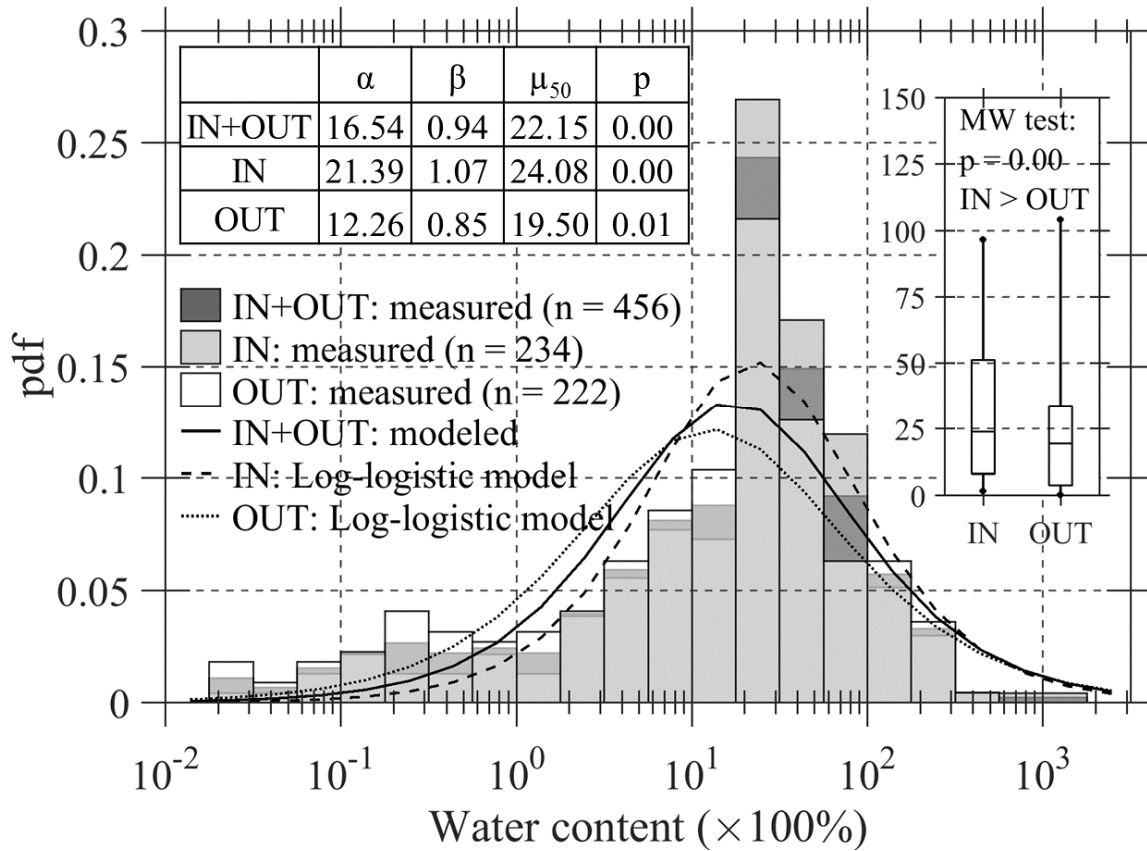

Figure 35 Probability density distribution (PDF) of all lumped and then separated MS4 data from reclaimed IN and OUT area for water content (WC). Median values (μ_{50}) are reported. Kolmogorov–Smirnov test ($p > 0.05$) indicates data fit log-logistic distribution with parameters α and β within 95% confidence intervals. Parameters α is a model index for the model median (central tendency) and β is a model index for the model scale (range of concentrations). The symbols represent histogram equivalents of the measured data. Comparison of the medians of IN and OUT data by Mann-Whitney U (MW) test are also reported (see statistical analysis for details).

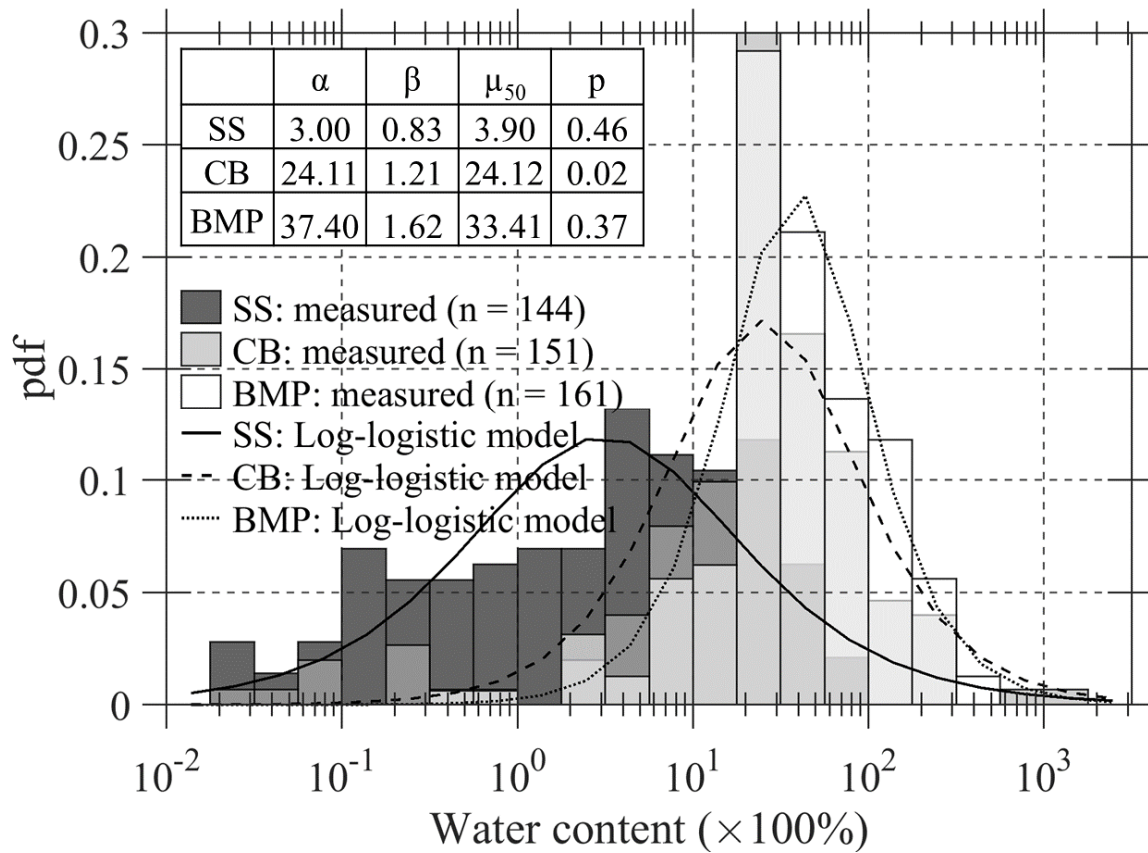

Figure 36 Probability density distribution (PDF of all lumped MS4 data (IN and OUT) by hydrologic functional units (HFUs) for water content (WC). Median values (μ_{50}) are reported. Kolmogorov–Smirnov test ($p > 0.05$) indicates data fit log-logistic distribution with parameters α and β within 95% confidence intervals. Parameters α is a model index for the model median (central tendency) and β is a model index for the model scale (range of concentrations). The symbols represent histogram equivalents of the measured data.

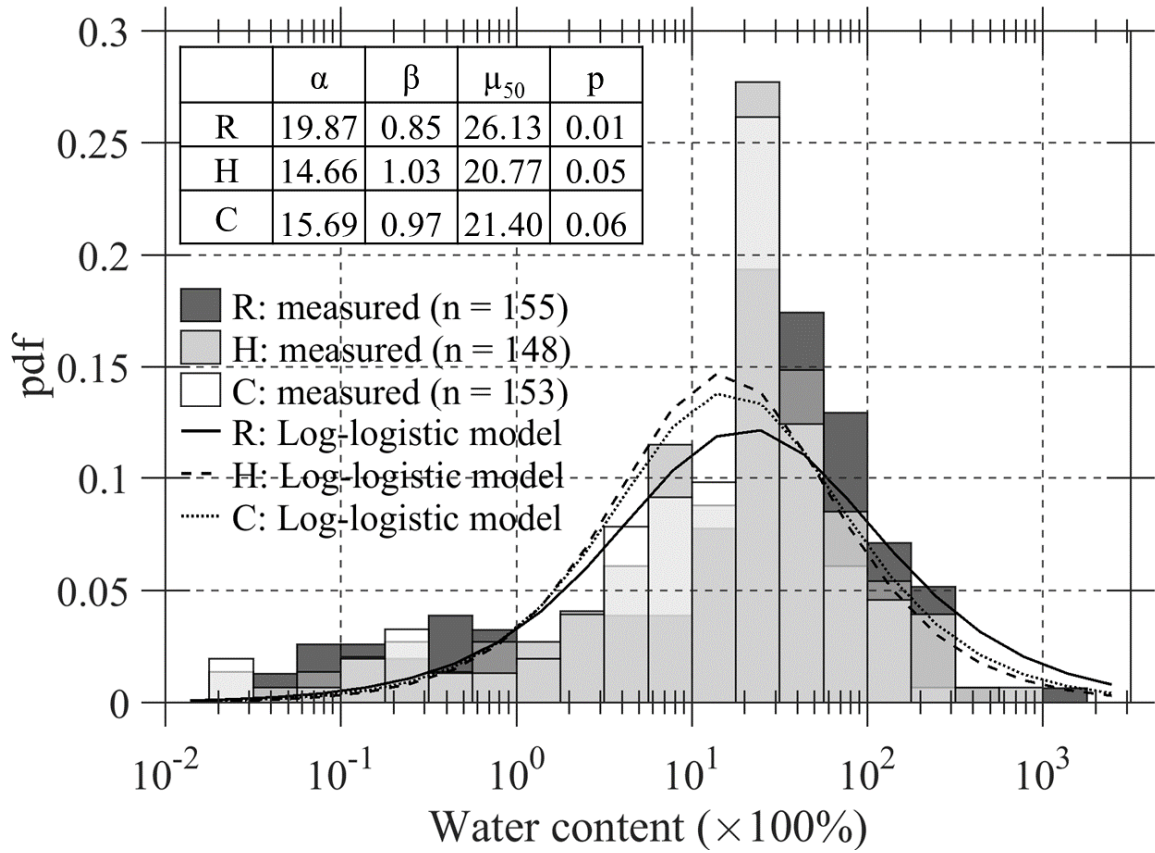

Figure 37 Probability density distribution (PDF of all lumped MS4 data (IN and OUT) by land uses for water content (WC). Median values (μ_{50}) are reported. Kolmogorov–Smirnov test ($p > 0.05$) indicates data fit log-logistic distribution with parameters α and β within 95% confidence intervals. Parameters α is a model index for the model median (central tendency) and β is a model index for the model scale (range of concentrations). The symbols represent histogram equivalents of the measured data.

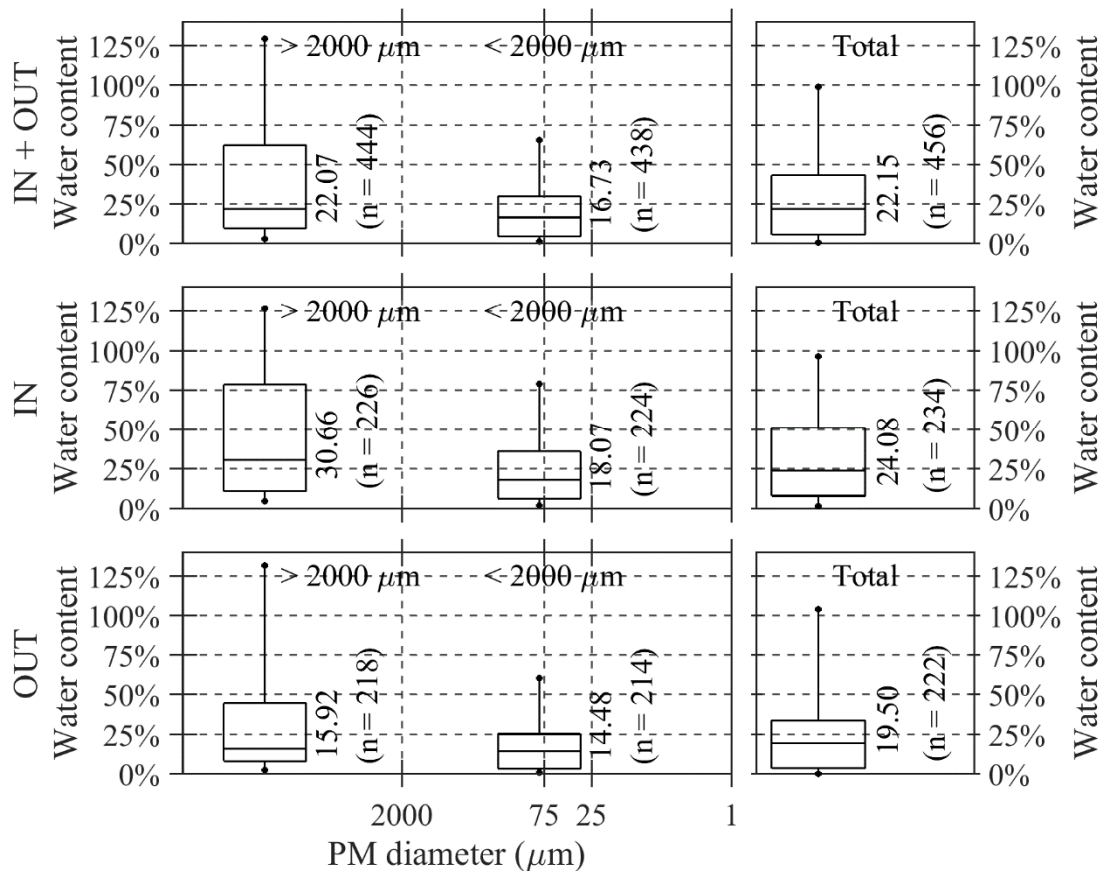

Figure 38 Box plots of all lumped and then separated MS4 data from reclaimed IN and OUT area for total and fractional water content (WC) across PM fractions that are coarser and finer than 2000 μm. Median and sample size (n) and of each plot are reported.

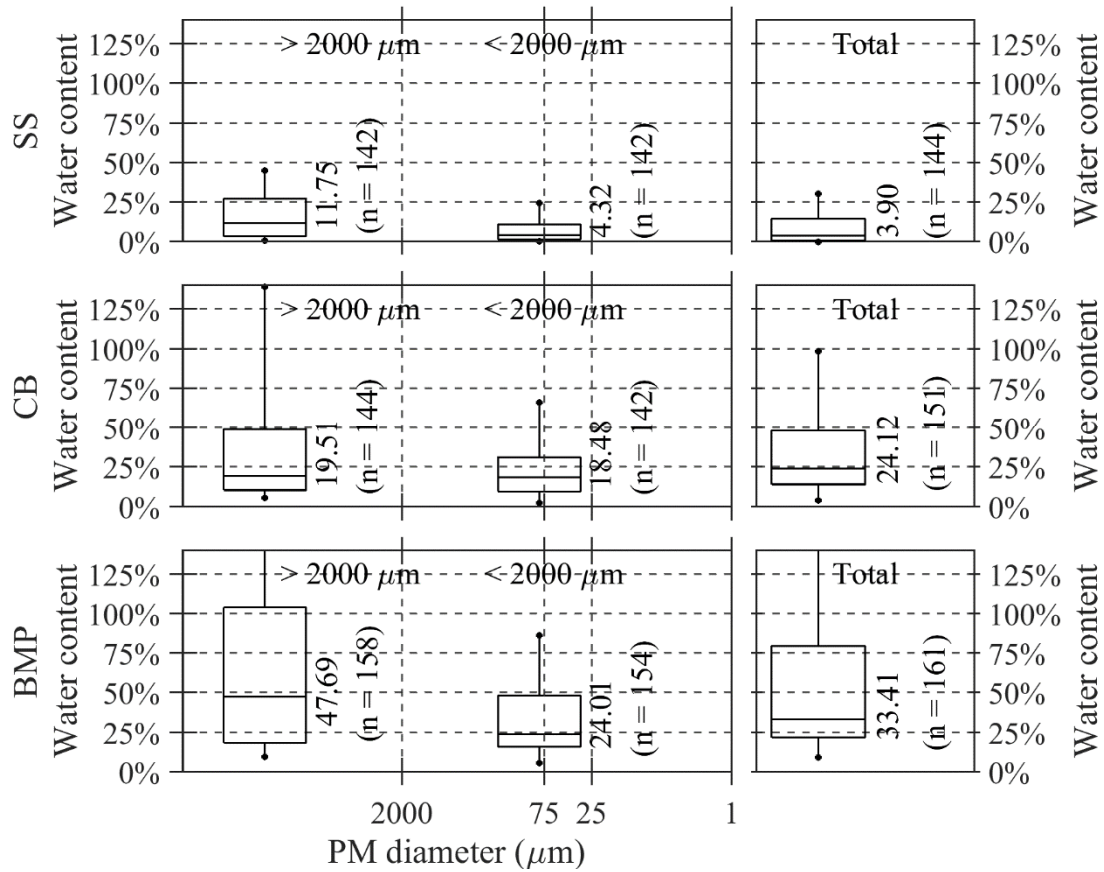

Figure 39 Box plots of all lumped MS4 data (IN and OUT) by hydrologic functional units (HFUs) for total and fractional water content (WC) across PM fractions that are coarser and finer than 2000 μm . Median and sample size (n) and of each plot are reported.

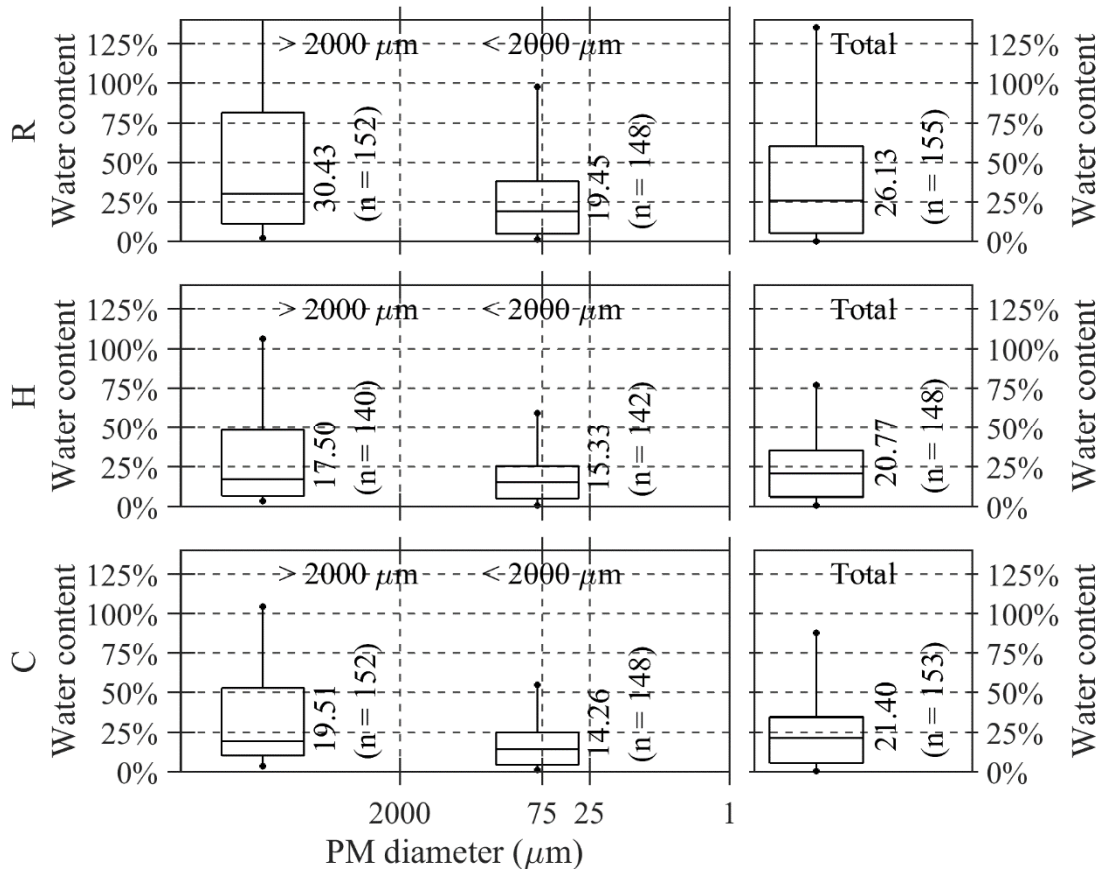

Figure 40 Box plots of all lumped MS4 data (IN and OUT) by land uses for total and fractional water content (WC) across PM fractions that are coarser and finer than 2000 μm. Median and sample size (n) and of each plot are reported.

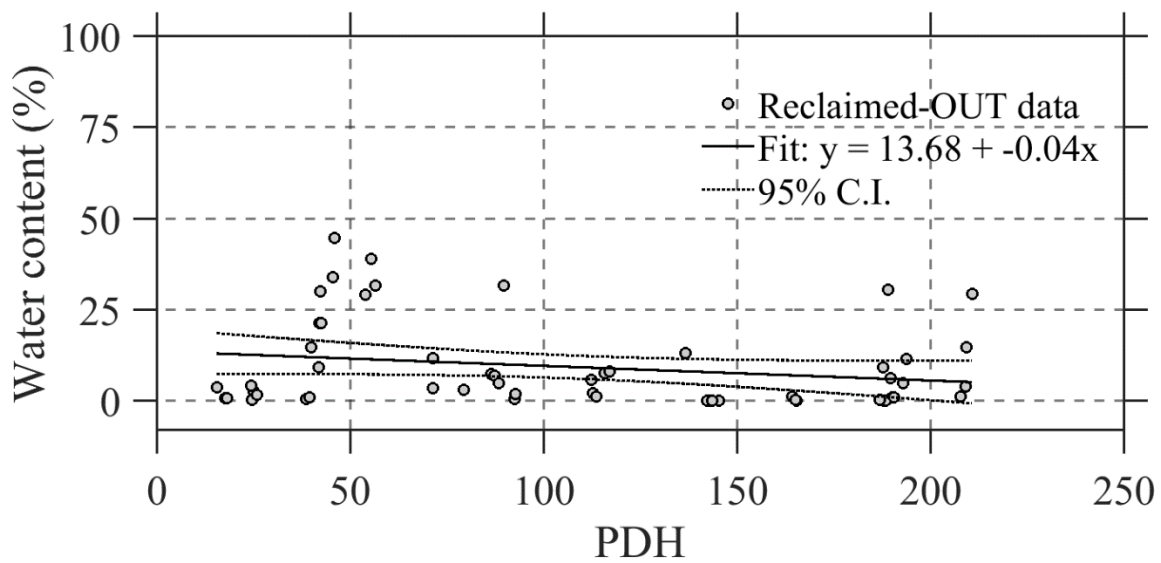
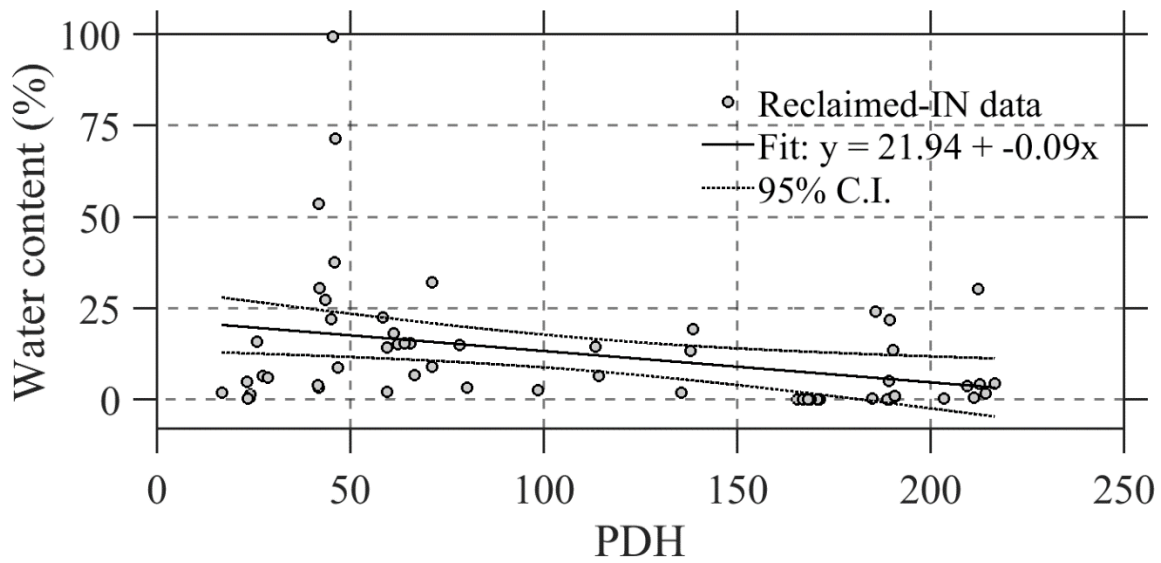

Figure 41 Correlation between previous dry hour (PDH) and water content of samples collected by street sweeping (SS) from inside (IN) or outside (OUT) reclaimed area. Linear regression is reported with 95% confidence interval (C.I.).

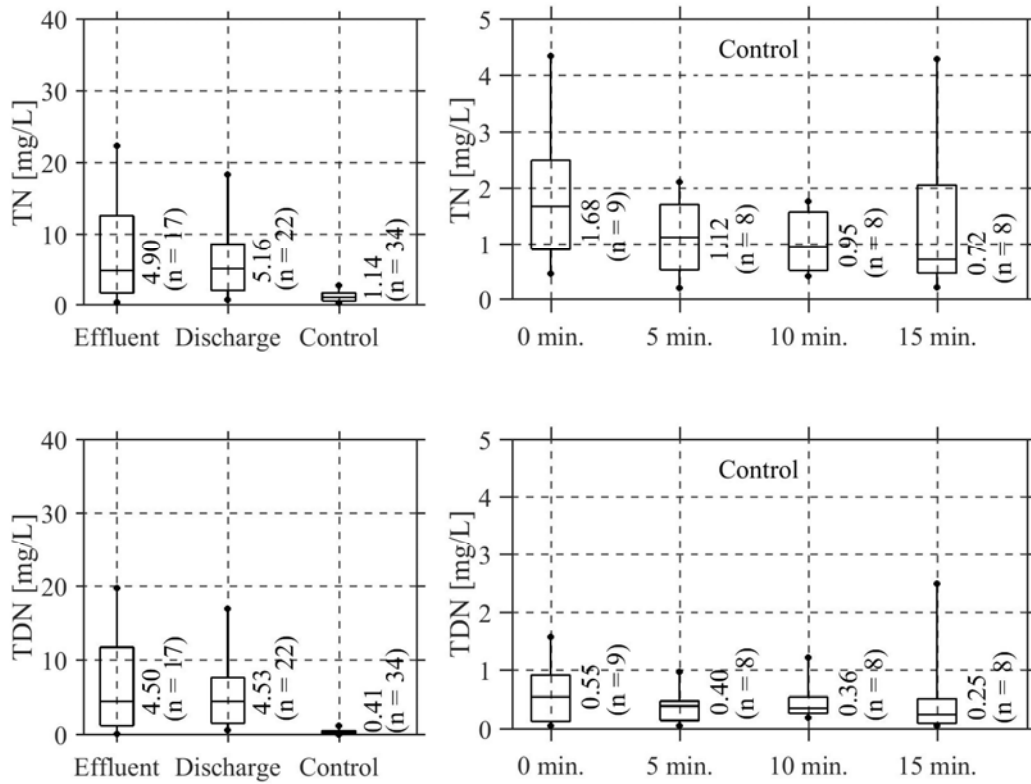

Figure 42 Box plots of all MS4 water samples for total nitrogen (TN) and total dissolved nitrogen (TDN) by WWTP effluent and distribution nozzle discharges inside reclaimed water area, control runoff samples (t = 0, 5, 10, 15 minutes) outside reclaimed water area. Time 0 represents the beginning of runoff. Median and sample size (n) and of each plot are reported.

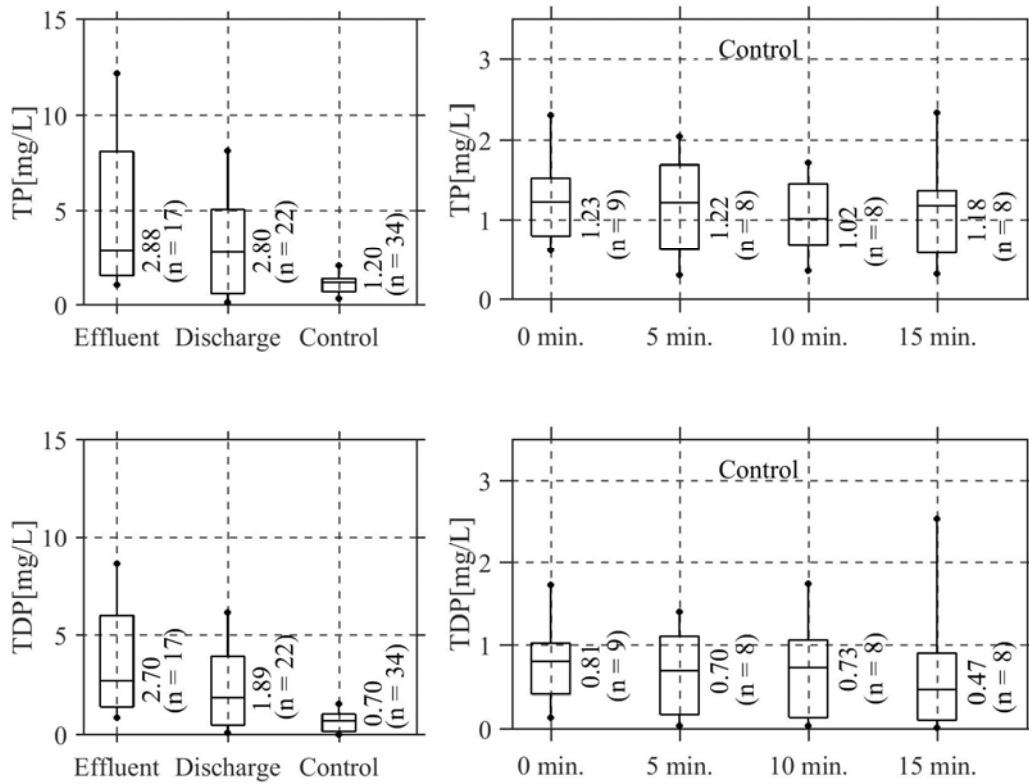

Figure 43 Box plots of all MS4 water samples for total phosphorus (TP) and total dissolved phosphorus (TDP) by WWTP effluent and distribution nozzle discharges inside reclaimed water area, control runoff samples (t = 0, 5, 10, 15 minutes) outside reclaimed water area. Time 0 represents the beginning of runoff. Median and sample size (n) and of each plot are reported.

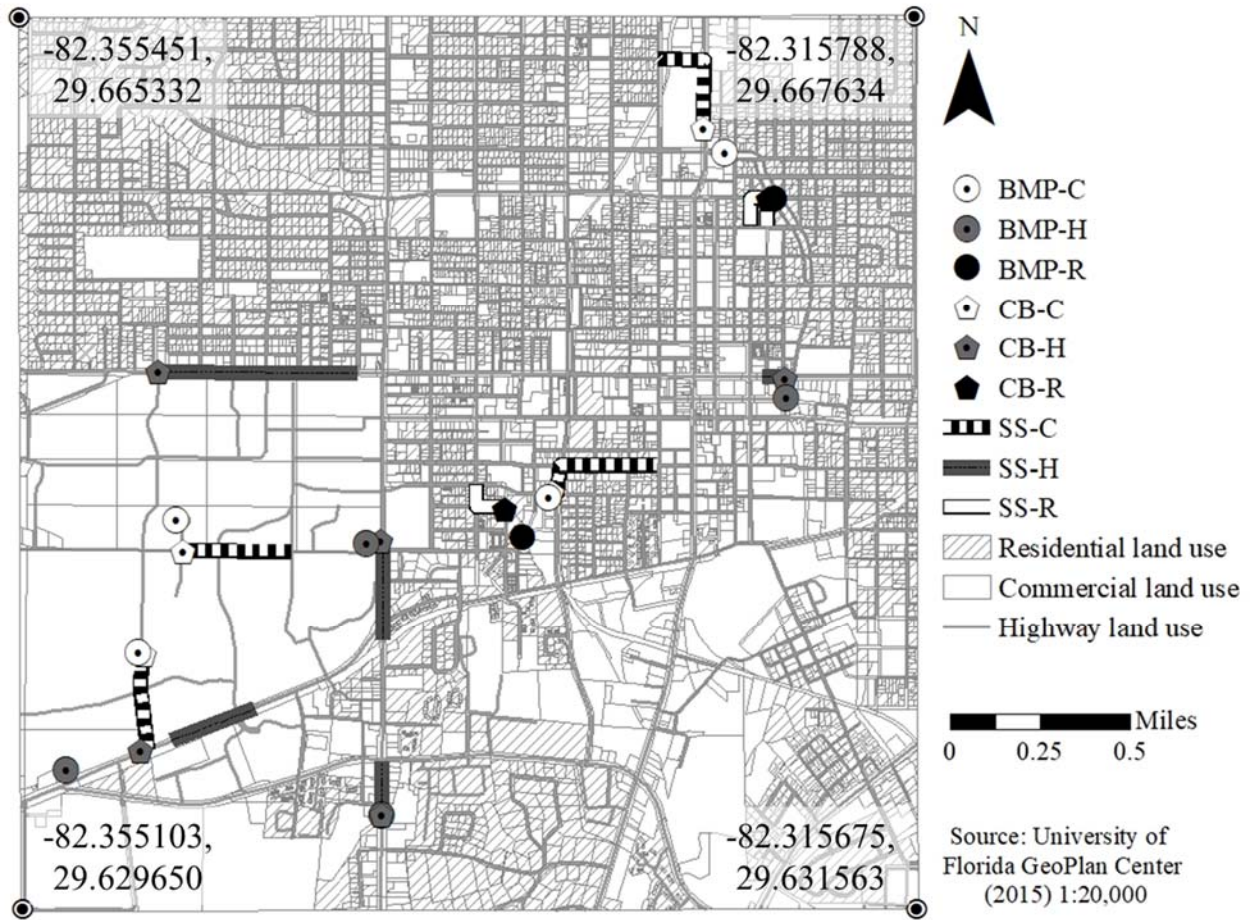

Figure 44 Example of unit area in GNV.

Table 1 Summary of applicable laboratory analyses for particulate and biogenic samples.

Parameter	Unit	Lab Method or Standard	Preservatives
Total Particulate P	[mg/kg]	USEPA 365.1 ¹	Cool to 4°C
Total Extractable P	[mg/kg]	Mehlich 3 ² , USEPA 200.7	Cool to 4°C
Leachable P	[mg/kg]	USEPA 1311	Cool to 4°C
Total Extractable NO ₃ ⁻	[mg/kg]	1 M KCl, USEPA 353.2	None required
Total Extractable NH ₃ +NH ₄ ⁺	[mg/kg]	USEPA 350.1	None required
Total Kjeldahl N	[mg/kg]	USEPA 351.2	None required
Leachable N	[mg/kg]	USEPA 1311	Cool to 4°C; acidify to pH < 2
Volatile suspended solids (VSS)	[mg/L]	SM.2540-A, G ³	Cool to 4°C
Particle size distribution (PSD)	—	ASTM D422 ⁴	None required
Moisture Content ⁵	(%)	ASTM D2216-98	Immediately after refrigeration

Notes:

1. USEPA Test Method, SW-846 (USEPA, 1998)
2. Extraction solution to extract P: Mehlich 3; Extraction solution to extract N: 1 M KCl
3. SM: Standard Methods for the examination of water and waste water, 20th Ed. (APHA, 1998)
4. American Standard Test Method (ASTM, 1998)
5. Moist: Moisture content between (1) an equilibrium condition with ambient atmosphere moisture content and (2) a visually detectable level of drainable porosity; in other words, separation of free water by gravity.

Table 2 Summary of applicable laboratory analyses for aqueous samples.

Parameter	Unit	Lab Method or Standard	Preservatives
Conductivity	[μ S/cm]	SM.2510	None required
Salinity	(ppm)	SM.2510	None required
Total dissolved solids (TDS)	[mg/L]	SM.2510	None required
Dissolved oxygen (DO)	[mg/L]	ASTM D888	None required
Turbidity	(NTU)	SM.2130	None required
Redox (Oxidation-Reduction Potential)	(mV)	SM.2580	None required
pH	[mg/kg]	ASTM D1293-18	None required
Alkalinity	[mg/L]	SM.2320	None required
Particle size distribution (PSD)	—	Laser diffraction ¹	None required
Suspended sediment concentration (SSC)	[mg/L]	ASTM D-3977-97	None required
Volatile suspended solids (VSS)	(%)	SM.2540-E	None required
Suspended PM concentration	[mg/L]	SM.2540-D	None required
Settleable PM concentration	[mg/L]	SM.2540-F	None required
Sediment PM concentration	[mg/L]	Sansalone and Kim, 2008 ²	None required
Total nitrogen (TN)	[mg/L]	Persulfate Digestion Method	Cool to 4°C; acidify to pH < 2
Total dissolved ³ nitrogen (TDN)	[mg/L]	Persulfate Digestion Method	Cool to 4°C; acidify to pH < 2
Total phosphorous (TP)	[mg/L]	SM.4500-P-B Acid Hydrolysis	Freeze
Total dissolved phosphorous (TDP)	[mg/L]	SM.4500-P-B Acid Hydrolysis	Freeze
Chemical oxygen demand (COD)	[mg/L]	Reactor Digestion Method ⁴	Cool to 4°C

Notes:

1. This study utilizes a Malvern Mastersizer 2000 with a particle size range from 0.02 to 2000 μ m, which is used to measure PSD (Piro et al. 2010). The principle of the instrument is based on laser diffraction.
2. Kim, J. Y., and Sansalone, J. J. (2008). Event-based size distributions of particulate matter transported during urban rainfall–runoff events. *Water Research*, 42(10–11), 2756–2768
3. The term “dissolved” is defined as the fraction of a constituent that passes through a 0.45 μ m membrane filter (4500-P A and 4500 N). Dissolved fraction is operationally defined as a binary separation between nominal “dissolved” and particulate (PM) phases of a constituent. (APHA, 1998, Dean et al. 2005)
4. Jirka, A.M.; Carter, M.J., *Analytical Chemistry*, 1975, 47(8), 1397

Table 3 This table represents the Florida-based metrics developed in this study to convert dry PM mass to a PM-based TP or TN in units of [mg/TP or TN per dry mass in kg of PM recovered] when considering water content (WC) as %. The metrics are presented as a function of HFU from PM recovered by street sweeping (SS), catch basin (CB) cleaning, and BMP maintenance. IN+OUT in the table represents the 50th percentile values for each HFU considering IN and OUT of reclaimed wastewater areas. The metrics are quantified as medians (50th percentile) and are used to illustrate a concise summary of the results in this report.

[mg/kg]	TN			TP			Water content (WC)		
	SS	CB	BMP	SS	CB	BMP	SS	CB	BMP
Inside	881	846	1209	259	315	283	4.71	28.24	41.68
Outside	561	909	1212	325	396	329	2.86	21.20	31.38
IN+OUT	656	891	1209	303	339	291	3.90	24.12	33.41

Table 4 Florida-based PM total phosphorus (TP) concentration 25th, median, and 75th percentile values as a function of each HFU and land use.

TP [mg/kg]	Street Sweeping (SS)			Catch Basin (CB)			BMP		
	25 th	Median	75 th	25 th	Median	75 th	25 th	Median	75 th
R	209	378	506	143	297	608	186	327	670
H	176	277	566	194	327	530	169	291	441
C	209	285	525	241	423	806	163	256	510

Table 5 Florida-based PM total nitrogen (TN) concentration 25th, median, and 75th percentile values as a function of each HFU and land use.

TN [mg/kg]	Street Sweeping (SS)			Catch Basin (CB)			BMP		
	25 th	Median	75 th	25 th	Median	75 th	25 th	Median	75 th
R	345	784	2191	288	857	3462	456	1493	4141
H	238	499	1076	208	581	1221	507	925	2253
C	365	881	1671	506	1231	4109	305	1256	2634

Table 6 Florida-based PM water content (WC) 25th, median, and 75th percentile values as a function of each HFU and land use.

Water content (%)	Street Sweeping (SS)			Catch Basin (CB)			BMP		
	25 th	Median	75 th	25 th	Median	75 th	25 th	Median	75 th
R	0.38	2.60	15.60	20.28	29.01	76.47	24.49	49.88	124.59
H	0.82	3.38	13.64	11.13	22.97	41.52	19.76	30.83	50.95
C	1.07	4.44	13.71	8.01	24.12	42.82	21.55	31.59	72.04

Table 7 Florida-based PM total phosphorus (TP) and total nitrogen (TN) concentration 25th, median and 75th percentile values for each HFU independent of land use.

[mg/kg]	TN			TP		
	25 th	Median	75 th	25 th	Median	75 th
Street Sweeping (SS)	306	656	1527	203	303	523
Catch Basin (CB)	294	891	2649	179	339	644
BMP	380	1209	2684	170	291	578

Table 8 PM mass fraction (%) as 4 PM operational size gradations (fractions) for all MS4s and each MS4 by total and 3 land uses (R, H, C), 3 hydrologic functional units (BMP, CB, SS).

PM Fractions (%)		All	LC	GNV	VC	SAC	MCO	ST	PC	APF	EC	SEC	BC	PIE
R	> 2000 μm	21.2	7.9	47.3	12.0	26.3	12.8	27.3	12.1	22.0	11.8	24.1	14.4	24.9
	75 - 2000 μm	76.3	84.7	52.0	87.5	69.0	83.2	71.0	86.2	76.2	85.1	72.6	85.1	72.7
	25 - 75 μm	2.4	7.1	0.6	0.5	4.6	3.9	1.6	1.7	1.7	3.0	3.3	0.5	2.2
	< 25 μm	0.1	0.4	0.1	0.0	0.1	0.0	0.0	0.0	0.0	0.0	0.1	0.0	0.2
H	> 2000 μm	23.5	9.9	35.1	14.1	23.2	13.9	28.9	17.5	41.9	30.3	38.6	8.3	22.2
	75 - 2000 μm	75.1	88.7	63.7	82.9	74.6	84.5	69.8	81.3	57.7	69.2	60.8	90.5	76.3
	25 - 75 μm	1.3	1.2	1.0	3.0	2.1	1.6	1.3	1.1	0.4	0.5	0.6	1.2	1.5
	< 25 μm	0.1	0.2	0.2	0.1	0.1	0.0	0.0	0.0	0.0	0.0	0.0	0.1	0.0
C	> 2000 μm	16.9	13.4	32.1	26.0	13.5	23.4	23.2	5.1	9.6	14.0	17.9	12.0	11.7
	75 - 2000 μm	81.7	85.4	66.4	73.1	81.9	75.3	76.5	93.7	89.8	85.2	81.5	86.8	86.0
	25 - 75 μm	1.3	1.1	1.2	0.9	4.5	1.3	0.4	1.2	0.6	0.8	0.6	1.1	2.2
	< 25 μm	0.1	0.2	0.3	0.0	0.1	0.0	0.0	0.0	0.0	0.0	0.0	0.0	0.1
SS	> 2000 μm	23.7	8.2	43.2	18.4	25.6	23.5	12.6	11.2	31.8	30.1	40.9	15.8	26.8
	75 - 2000 μm	74.5	87.1	55.5	80.9	70.5	73.5	85.3	87.7	67.5	68.8	57.9	83.4	71.3
	25 - 75 μm	1.7	4.3	1.0	0.7	3.8	3.0	2.1	1.1	0.7	1.1	1.2	0.9	1.6
	< 25 μm	0.1	0.3	0.2	0.0	0.1	0.0	0.0	0.0	0.0	0.0	0.0	0.0	0.2
CB	> 2000 μm	17.8	15.3	31.4	9.4	22.2	14.9	29.7	11.4	22.1	13.7	20.4	7.6	16.0
	75 - 2000 μm	80.6	81.7	67.8	88.3	74.8	82.8	69.6	87.3	76.4	85.0	79.2	92.0	82.3
	25 - 75 μm	1.5	2.9	0.7	2.2	3.0	2.2	0.6	1.2	1.4	1.2	0.4	0.4	1.6
	< 25 μm	0.1	0.2	0.2	0.1	0.0	0.0	0.0	0.0	0.0	0.0	0.0	0.0	0.1
BMP	> 2000 μm	19.7	7.6	38.9	24.3	15.3	11.7	37.0	12.1	19.5	14.3	20.2	9.5	19.1
	75 - 2000 μm	78.5	89.9	59.8	74.3	80.3	86.8	62.3	86.3	79.9	84.2	78.5	88.8	78.1
	25 - 75 μm	1.7	2.2	1.1	1.4	4.3	1.5	0.7	1.6	0.6	1.5	1.2	1.6	2.7
	< 25 μm	0.1	0.3	0.2	0.0	0.1	0.0	0.0	0.0	0.0	0.0	0.0	0.1	0.1
Total	> 2000 μm	20.4	10.4	38.3	17.4	21.0	16.7	26.5	11.6	24.5	19.6	27.7	11.6	19.7
	75 - 2000 μm	77.8	86.3	60.6	81.2	75.2	81.0	72.4	87.1	74.6	79.2	71.4	87.4	78.2
	25 - 75 μm	1.6	3.1	0.9	1.4	3.7	2.2	1.1	1.3	0.9	1.3	1.0	1.0	2.0
	< 25 μm	0.1	0.3	0.2	0.1	0.1	0.0	0.0	0.0	0.0	0.0	0.0	0.1	0.1

Table 9. Calculation of total nitrogen (TN) and total phosphorus (TP) as areal-weighting value for only residential (R) land use in unit area.

Sample ID	i	Contributing area A_i (ft ²)	TN C_i [mg/kg]	TP C_i [mg/kg]
GNV-BMP-R-OUT-2	1	21528	3879	912
GNV-BMP-R-OUT-3	2	21528	9345	1877
GNV-CB-R-OUT-2	3	10000	7444	775
GNV-CB-R-OUT-3	4	10000	1833	554
GNV SS R OUT 2	5	49850	1547	533
GNV SS R OUT 3	6	37650	4092	1599
$C_{average}$ for R = $\Sigma C_i A_i / \Sigma A_i$			4042	1063

Table 10 Result and calculation of total nitrogen (TN) and total phosphorus (TP) as areal-weighting value for whole unit area. Area of residential (R), highway (H), and commercial (C) are also reported.

Land use	Unit area	TN	TP
	A_i (mi ²)	C_i (mg/kg)	C_i (mg/kg)
R	2.23	4042	1063
H	0.12	2880	818
C	3.65	5093	1160
Result = $\Sigma C_i A_i / \Sigma A_i$		4659	1117

APPENDIX

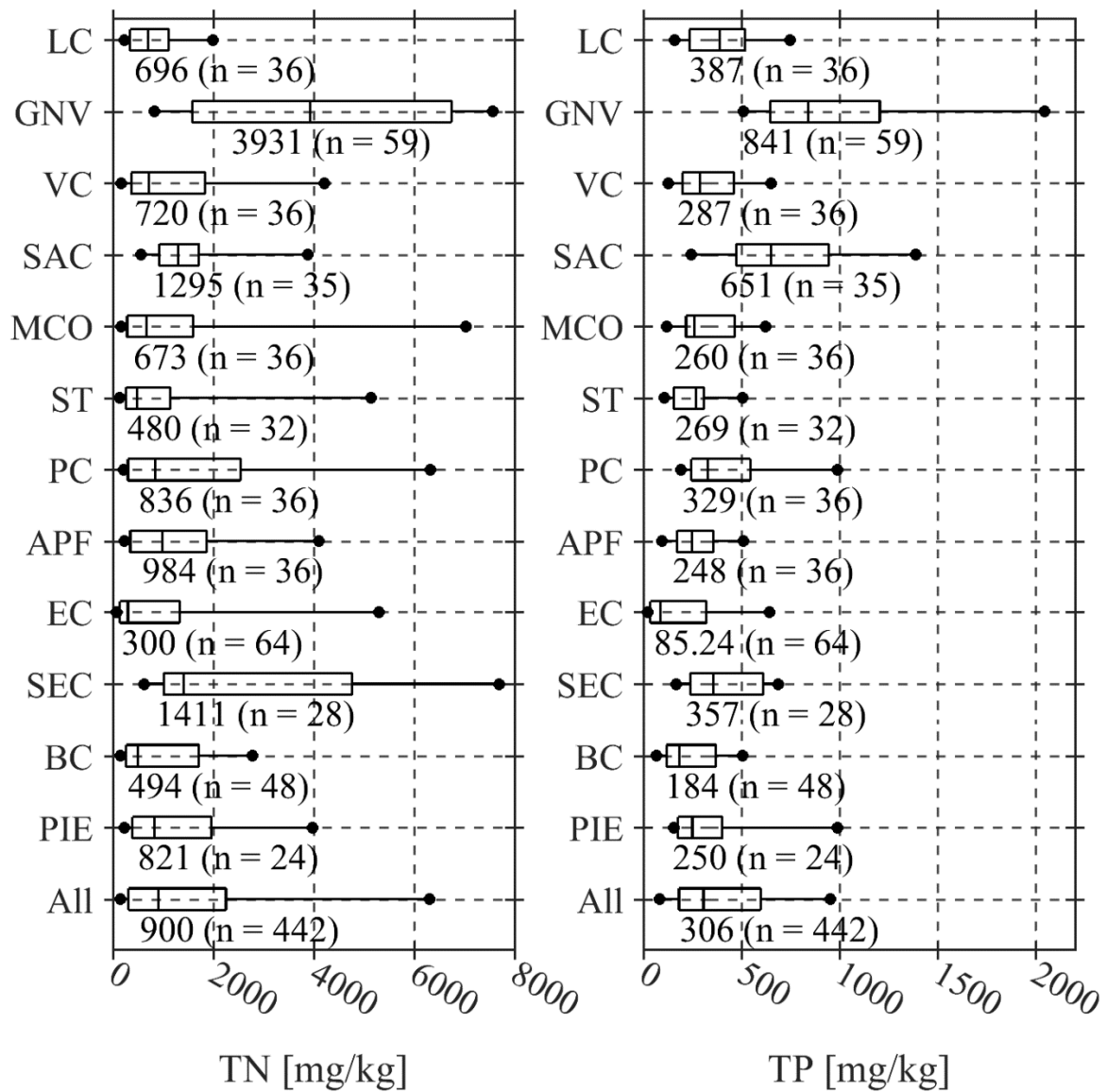

Figure 45 Non-parametric box plots of all lumped data (IN and OUT) by individual MS4 for total nitrogen (TN) and total phosphorus (TP). Median and sample size (n) of each plot are reported.

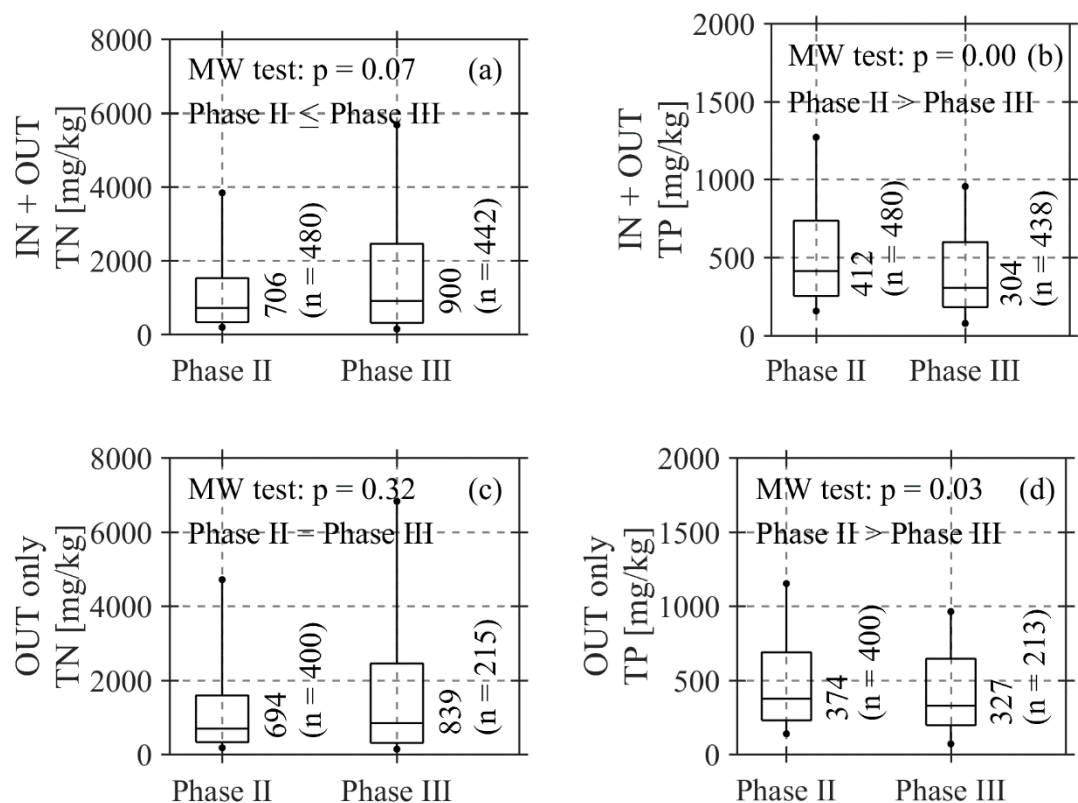

Figure 46 This figure provides an alternative comparison to Figure 11. This figure examines results based on the statistical equivalence of IN and OUT concentrations [mg/kg] as determined for Phase III and tests these (IN + OUT) results against the combination of (IN + OUT) from Phase II. Therefore plot (a) is (IN + OUT) and indicates the median TN is statistically less than or equal in Phase II compared to Phase III when testing the combined (IN + OUT) datasets from each phase. However, plot (c) compares TN based only on OUT datasets from each phase and results in a statistical equivalence between Phase II and III. Plot (b) indicates the median TP of Phase II is statistically greater than Phase III when comparing (IN + OUT) and plot (d) which compares only the OUT databases of each phase indicates that Phase II is greater than Phase III for TP. Comparison of the medians of IN and OUT data by the Mann-Whitney U test (MW) are also reported (see Methodology for statistical testing details).

The comparison using Mann-Whitney U test had three steps:

- 1) two-tailed hypothesis: median of x1 is equal to median of x2
- 2) right-tailed hypothesis: median of x1 is less or equal to median of x2
- 3) left-tailed hypothesis: median of x1 is greater or equal to median of x2

For plot (a), step 1 test gives p-value of 0.07 indicating that there's no significant difference. But the step 2 yields a p-value larger than 0.05 that Phase II could be smaller or equal to Phase III. Only step 3 has a p-value smaller than 0.05 that Phase II is not larger than Phase III. Therefore, the result of plot (a) is that TN from Phase II has a less or equal to the median of Phase III using IN+OUT data.