

**MARCH 2010 DRAFT**

**DEPARTMENT OF ENVIRONMENTAL PROTECTION AND  
WATER MANAGEMENT DISTRICTS**

**ENVIRONMENTAL RESOURCE PERMIT  
STORMWATER QUALITY  
APPLICANT'S HANDBOOK**

**DESIGN REQUIREMENTS FOR  
STORMWATER TREATMENT SYSTEMS IN FLORIDA**

<insert effective date>



**Southwest Florida  
Water Management District**



TABLE OF CONTENTS

**PART I – GENERAL CRITERIA ..... 1**

    1.0      *Introduction* ..... 1

    1.1      *Applicability* ..... 1

    1.2      *Off-site Stormwater Treatment* ..... 1

    1.3      *Best Management Practices (BMP) Treatment Train Nutrient  
            Reduction Credits* ..... 2

    1.4      *Alternative Designs* ..... 2

    1.5      *Inspection and Recertification of Stormwater Treatment Systems* ..... 2

**PART II – DEFINITIONS ..... 4**

    2.0      *Definitions* ..... 4

**PART III – STORMWATER QUALITY PERMITTING REQUIREMENTS ..... 6**

    3.1      *Performance Standards* ..... 6

    3.2      *Additional Permitting Requirements to Protect Ground Water* ..... 8

    3.3      *Calculating Required Nutrient Load Reduction* ..... 8

    3.4      *Calculating Pollutant Loading for Natural Vegetative Community  
            Types (pre-development)* ..... 9

    3.5      *Calculation of Post-Development Loading* ..... 10

    3.6      *Oil and Grease Control* ..... 19

    3.7      *Hazardous or Toxic Substances* ..... 19

    3.8      *Off-site Stormwater* ..... 19

**PART IV – EROSION AND SEDIMENT CONTROL..... 21**

    4.0      *Erosion and Sediment Control*..... 21

    4.1      *Overview* ..... 21

    4.2      *Development of an Erosion and Sediment Control Plan*..... 22

    4.3      *Development of a Stormwater Pollution Prevention Plan (SWPPP) for  
            NPDES Requirements*..... 23

    4.4      *Sediment Sump Design Example*..... 27

**PART V – BEST MANAGEMENT PRACTICES ..... 29**

    5.0      **RETENTION BASIN DESIGN CRITERIA**..... 29

        5.1      *Description*..... 29

        5.2      *Required Treatment Level and Associated Treatment Volume* ..... 29

        5.3      *Calculating Load Reduction Efficiency for a Given Retention Volume* ..... 30

        5.4      *Design Criteria* ..... 30

        5.5      *Required Site Information* ..... 31

        5.6      *Retention Basin Construction*..... 31

        5.7      *Inspections, Operation and Maintenance* ..... 32

    6.0      **EXFILTRATION TRENCH DESIGN CRITERIA** ..... 34

        6.1      *Description*..... 34

        6.2      *Required Level of Treatment and Associated Treatment Volume*..... 34

6.3	<i>Calculating Load Reduction Efficiency for a Given Retention Volume</i> .....	36
6.4	<i>Design and Performance Criteria</i> .....	36
6.5	<i>Required Site Information</i> .....	37
6.6	<i>Construction requirements</i> .....	40
6.7	<i>Inspections, Operation and Maintenance</i> .....	41
<b>7.0</b>	<b>UNDERGROUND STORAGE AND RETENTION SYSTEMS</b>	
	<b>DESIGN CRITERIA</b> .....	<b>43</b>
7.1	<i>Description</i> .....	43
7.2	<i>Required Treatment Volume</i> .....	43
7.3	<i>Calculating Load Reduction Efficiency for a Given Retention Volume</i> .....	43
7.4	<i>Design Criteria</i> .....	43
7.5	<i>Required Site Information</i> .....	45
7.6	<i>Construction requirements</i> .....	45
7.8	<i>Inspections, Operation and Maintenance</i> .....	46
<b>8.0</b>	<b>UNDERGROUND RETENTION VAULT / CHAMBER</b>	
	<b>SYSTEMS DESIGN CRITERIA</b> .....	<b>49</b>
8.1	<i>Description</i> .....	49
8.2	<i>Required Treatment Volume</i> .....	49
8.3	<i>Calculating Load Reduction Efficiency for a Given Retention Volume</i> .....	50
8.4	<i>Design Criteria</i> .....	50
8.5	<i>Required Site Information</i> .....	51
8.5	<i>Construction requirements</i> .....	51
8.6	<i>Inspections, Operation and Maintenance Requirements</i> .....	53
<b>9.0</b>	<b>SWALES</b> .....	<b>56</b>
9.1	<i>Description</i> .....	56
9.2	<i>Swales with Swale Blocks or Raised Driveway Culverts (Linear Retention Systems)</i> .....	56
9.3	<i>Swales without Swale Blocks or Raised Driveway Culverts (Conveyance Swales)</i> .....	56
9.4	<i>Design Criteria for Swales</i> .....	58
9.5	<i>Soil Requirements and Testing Requirements</i> .....	59
9.6	<i>Construction and Stabilization Requirements</i> .....	59
9.7	<i>Inspections, Operation and Maintenance Requirements</i> .....	60
<b>10.0</b>	<b>VEGETATED NATURAL BUFFERS</b> .....	<b>62</b>
10.1	<i>Description</i> .....	62
10.2	<i>Required Treatment</i> .....	62
10.3	<i>Calculating Load Reduction Efficiency for a Given Retention Volume</i> .....	63
10.4	<i>Design Criteria</i> .....	64
10.5	<i>Required Site Information</i> .....	65
10.6	<i>Construction requirements</i> .....	65
10.7	<i>Inspections, Operation and Maintenance</i> .....	65

<b>11.0</b>	<b>PERVIOUS PAVEMENT SYSTEMS .....</b>	<b>68</b>
11.1	<i>Description.....</i>	68
11.2	<i>Applicability.....</i>	68
11.3	<i>Required Treatment Volume.....</i>	69
11.4	<i>Calculating Load Reduction Efficiency for a Given Retention Volume .....</i>	70
11.5	<i>Design Criteria .....</i>	70
11.6	<i>Required Site Information .....</i>	73
11.7	<i>Construction requirements .....</i>	73
11.8	<i>Inspection, Operation and Maintenance.....</i>	74
<b>12.0</b>	<b>GREEN ROOF/CISTERN SYSTEM DESIGN CRITERIA.....</b>	<b>83</b>
12.1	<i>Description.....</i>	83
12.2	<i>Required Treatment Volume.....</i>	83
12.3	<i>Classification of Greenroof Surfaces .....</i>	83
12.4	<i>Design Criteria .....</i>	85
12.5	<i>Design Criteria for Management of the Filtrate .....</i>	87
12.8	<i>Greenroof Cistern/Harvesting Design Curves and Equations .....</i>	89
<b>13.0</b>	<b>WET DETENTION SYSTEMS .....</b>	<b>109</b>
13.1	<i>Description.....</i>	109
13.2	<i>Treatment required.....</i>	109
13.3	<i>Bleed-down Volume .....</i>	109
13.4	<i>Design Criteria .....</i>	110
13.5	<i>Required Site Information .....</i>	115
13.6	<i>Detention Pond Construction .....</i>	117
13.7	<i>Inspections, Operation and Maintenance .....</i>	118
<b>14.0</b>	<b>MANAGED AQUATIC PLANT SYSTEM (MAPS) DESIGN CRITERIA .....</b>	<b>120</b>
14.1	<i>Description.....</i>	120
14.2	<i>Nutrient Removal Effectiveness and Credits.....</i>	120
14.3	<i>Littoral Zone Design Criteria .....</i>	120
<b>15.0</b>	<b>STORMWATER HARVESTING DESIGN CRITERIA .....</b>	<b>128</b>
15.1	<i>Description.....</i>	128
15.2	<i>Treatment required.....</i>	128
15.3	<i>Equivalent Impervious Area .....</i>	129
15.4	<i>Design Criteria .....</i>	129
15.5	<i>Construction requirements .....</i>	132
15.6	<i>Inspections, Operation and Maintenance .....</i>	133
15.7	<i>Rate-Efficiency-Volume (REV) Curves.....</i>	133
<b>16</b>	<b>DESIGN CRITERIA FOR WETLAND STORMWATER TREATMENT TRAINS .....</b>	<b>137</b>
16.1	<i>Description.....</i>	137



16.2	<i>Types of Wetlands that May Be Used for Stormwater Treatment</i> .....	137
16.3	<i>Required Treatment</i> .....	137
16.4	<i>Nutrient Treatment Credit</i> .....	137
16.5	<i>Design Criteria and Other Requirements for Incorporating Wetlands into Stormwater BMP Treatment Trains</i> .....	138
16.6	<b>Construction requirements</b> .....	139
16.7	<b>Inspection, Operation, and Maintenance</b> .....	139
<b>17.0</b>	<b>UNDERDRAIN FILTRATION SYSTEM DESIGN CRITERIA</b> .....	140
17.1	<i>Description</i> .....	140
17.2	<i>Required Treatment Volume</i> .....	140
17.3	<i>Design Criteria</i> .....	140
17.4	<i>Required Site Information</i> .....	143
17.5	<i>Construction requirements</i> .....	143
17.6	<i>Inspections, Operation and Maintenance</i> .....	144
<b>18.0</b>	<b>LOW IMPACT DESIGN BMPS – DESIGN AND LOAD REDUCTION CREDITS</b> .....	146
18.1	<i>Natural Area Conservation Credit</i> .....	146
18.2	<i>Site Reforestation Credit</i> .....	147
18.3	<i>Disconnection of Impervious Area Credit</i> .....	148
18.4	<i>Florida-friendly Landscaping Credit</i> .....	149
18.5	<i>Rural Subdivisions</i> .....	150
<b>19.0</b>	<b>CHEMICAL TREATMENT CRITERIA</b> .....	152
19.1	<i>Description</i> .....	152
19.2	<i>Treatment Process Background</i> .....	152
19.3	<i>Applicability</i> .....	153
19.4	<i>Treatment Efficiency</i> .....	153
19.5	<i>Preliminary Design Evaluation to Determine Alum Dosage</i> .....	154
19.6	<i>Stormwater Retrofit Systems</i> .....	154
19.7	<i>Alum Treatment for New Development Projects</i> .....	155
19.8	<i>Laboratory Jar Testing</i> .....	155
19.9	<i>Design Criteria</i> .....	156
19.10	<i>System Safeguards</i> .....	157
19.11	<i>Floc Collection and Disposal</i> .....	157
19.12	<i>System Discharge</i> .....	158
19.13	<i>Maintenance Requirements and Entities</i> .....	158
19.14	<i>Inspections</i> .....	158
19.15	<i>Monitoring Requirements</i> .....	158
19.16	<i>Operational Reporting Requirements</i> .....	159
<b>20.0</b>	<b>URBAN STORMWATER RETROFIT PROJECTS</b> .....	160
20.1	<i>Description</i> .....	160

20.2	<i>Goals and Performance Standards</i> .....	160
20.3	<i>Design and Selection of Applicable BMPs</i> .....	160
<b>PART V – METHODOLOGIES AND DESIGN EXAMPLES</b> .....		<b>161</b>
<b>21.0</b>	<b>METHODOLOGIES, RECOVERY ANALYSIS, AND SOIL TESTING FOR RETENTION SYSTEMS</b> .....	<b>161</b>
21.1	<i>Description</i> .....	161
21.2	<i>Required Treatment Volume (RTV)</i> .....	162
21.3	<i>Recovery Time of the RTV</i> .....	162
21.4	<i>Infiltration Processes</i> .....	163
21.5	<i>Accepted Methodologies for Determining Retention BMP Recovery</i> .....	164
21.6	<i>Requirements, Guidance and Recommendations for Manual Computations or Computer Simulations</i> .....	165
21.7	<i>Requirements, Guidance and Recommendations for BMP Soil Testing</i> .....	169
<b>22.0</b>	<b>DESIGN EXAMPLES FOR RETENTION SYSTEMS</b> .....	<b>172</b>
22.1	<i>To Achieve 85% Post-Development Nutrient Load Reduction</i> .....	172
22.2	<i>To Calculate Post-Development Not To Exceed Pre-Development Conditions</i> .....	173
22.3	<i>Dry Retention In Series – Calculating Treatment Efficiency Example</i> .....	175
<b>23.0</b>	<b>METHODOLOGY AND DESIGN EXAMPLE FOR GREENROOF/CISTERN SYSTEMS</b> .....	<b>179</b>
23.1	<i>To Achieve 85% Post-Development Nutrient Load Reduction</i> .....	179
23.2	<i>To Calculate Post-Development Not To Exceed Pre-Development Conditions</i> .....	179
<b>24.0</b>	<b>METHODOLOGY AND DESIGN EXAMPLE FOR PERVIOUS PAVEMENT</b> .....	<b>181</b>
<b>25.0</b>	<b>METHODOLOGY AND DESIGN EXAMPLE FOR WET DETENTION SYSTEMS</b> .....	<b>182</b>
25.1	<i>BMP Treatment Train To Achieve 85% Post-Development Nutrient Load Reduction</i> .....	182
25.2	<i>Wet Detention System Treatment Train to Meet Post=Pre Loading Design Example</i> .....	187
25.3	<i>Wet Detention In Series – Calculating Treatment Efficiency Example</i> .....	190
<b>26.0</b>	<b>METHODOLOGY AND DESIGN EXAMPLE FOR STORMWATER HARVESTING SYSTEMS</b> .....	<b>198</b>
26.1	<i>Design Examples for Stormwater Harvesting Systems</i> .....	198
<b>27.0</b>	<b>METHODOLOGY AND DESIGN EXAMPLE FOR SWALES</b> .....	<b>201</b>
<b>28.0</b>	<b>METHODOLOGY AND DESIGN EXAMPLE FOR VEGETATED NATURAL BUFFER SYSTEMS</b> .....	<b>202</b>
<b>29.0</b>	<b>METHODOLOGY AND DESIGN EXAMPLE FOR UNDERDRAIN FILTRATION SYSTEMS</b> .....	<b>203</b>

30.0	SPECIAL BASIN CRITERIA: SENSITIVE KARST AREAS.....	204
31.0	INSPECTION, OPERATION, AND MAINTENANCE OF STORMWATER TREATMENT SYSTEMS.....	209
32.0	OPERATION AND MAINTENANCE ENTITIES AND REQUIREMENTS FOR STORMWATER TREATMENT SYSTEMS.....	218
APPENDIX A	OTHER RULE & STATUTORY REFERENCES RELATED TO THIS HANDBOOK.....	224
APPENDIX B	CORRELATION OF NATURAL VEGETATIVE COMMUNITY TYPES WITH SOIL SERIES.....	241
APPENDIX C	DESCRIPTION OF LAND USE CATEGORIES AND RELATED EVENT MEAN CONCENTRATIONS.....	256
APPENDIX D:	DRY RETENTION DEPTHS FOR 85% MASS REMOVAL.....	257
APPENDIX E:	CALCULATED ANNUAL RUNOFF COEFFICENTS FOR DESIGNATED METEOROLOGICAL ZONES AS A FUNCTION OF CURVE NUMBER AND DCIA .....	260
APPENDIX F:	DRY RETENTION SYSTEM MEAN ANNUAL NUTRIENT LOAD REDUCTION EFFICIENCY FOR VARIOUS RUNOFF DEPTHS AND METEROLOGICAL ZONES AS A FUNCTION OF DCIA AND NON-DCIA CURVE NUMBER .....	266
APPENDIX G	SENSITIVE KARST AREA MAPS AND LEGAL DESCRIPTIONS .....	322
APPENDIX H	INSPECTION CHECKLIST FORMS.....	371
APPENDIX I	REFERENCES AND OTHER EDUCATIONAL MATERIALS TO ASSIST USERS IN DESIGNING BETTER STORMWATER TREATMENT SYSTEMS.....	385

List of Tables

<b>Table 1.1</b>	<b>Stormwater Treatment System Recertification Frequency</b> .....	3
Table 3.1	Stormwater Treatment Performance Standards.....	7
Table 3.2	Natural Vegetative Community Areal Loading Rates .....	10
Table 3-3	Counties Included in the Designated Meteorological Zones .....	13
Table 3.4	Summary of Literature-based Runoff Characterization Data for General Land Use Categories in Florida .....	19
Table 12-1	Plants that have been successfully used on greenroofs in Florida.....	86
Table 14.1	Nutrient Removal Credits for MAPS .....	120
Table 14-2	Native Plant Species Suitable for Littoral Zone Plantings or Adjacent to Wet Detention Ponds .....	122

<i>Table 21.1 Accepted Methodologies for Retention BMP Recovery.....</i>	<i>164</i>
<i>Table 25.4-1 Basin Characteristics for Example Problem .....</i>	<i>192</i>
<i>Table 25.4-2 Generated Runoff Loadings for Example Problem .....</i>	<i>193</i>
<i>Table 25.4-3 Pond Characteristics – Short Detention Times .....</i>	<i>194</i>
<i>Table 25.4-4. Pond Removal Calculations for Total P (Short Detention Times) .....</i>	<i>196</i>

## List of Figures

<i>Figure 3.1 Designated Meteorological Regions (Zones) in Florida .....</i>	<i>12</i>
<i>Figure 3.2 Rainfall Isopleth Map for Florida.....</i>	<i>14</i>
<i>Figure 3.3 Rainfall Isopleth Map for Northwest Florida.....</i>	<i>15</i>
<i>Figure 3.4 Rainfall Isopleth Map for Northeast-North Central Florida.....</i>	<i>16</i>
<i>Figure 3.5 Rainfall Isopleth Map for Central Florida .....</i>	<i>17</i>
<i>Figure 3.6 Rainfall Isopleth Map for South Florida.....</i>	<i>18</i>
<i>Figure 3.7 Oil Skimmer Detail for a Typical Outfall Structure (N.T.S.).....</i>	<i>20</i>
<i>Figure 5.1 Typical Cross-section of “Dry” Retention Basin.....</i>	<i>30</i>
<i>Figure 6.1 Cross-section of a “DRY” Exfiltration Trench (N.T.S.) .....</i>	<i>35</i>
<i>Figure 6.2 Generic “WET” exfiltration trench .....</i>	<i>35</i>
<i>Figure 6.3 Typical Exfiltration Trench Sumps and Dead End Details .....</i>	<i>38</i>
<i>Figure 6.4 Detail for Exfiltration Trench Trash Baffle .....</i>	<i>39</i>
<i>Figure 6.5 Generic Detail for a Typical Exfiltration Trench Trash Tee .....</i>	<i>40</i>
<i>Figure 7.1 Generic Underground Retention System .....</i>	<i>45</i>
<i>Figure 8.1 Generic Underground Retention Vault or Chamber.....</i>	<i>49</i>
<i>Figure 8.2 Generic Detail for an Up-Gradient Underground Vault/Chamber System.....</i>	<i>52</i>
<i>Sediment &amp; Trash Baffle .....</i>	<i>52</i>
<i>Figure 8.3 Alternate Generic Detail for an Up-Gradient Underground Vault/Chamber System Sediment &amp; Trash Tee.....</i>	<i>53</i>
<i>Figure 9.1 Typical Cross-section of a Conveyance Swale without Swale Blocks.....</i>	<i>57</i>
<i>Figure 10.1 Plan View Schematic of Typical Vegetative Natural Buffer.....</i>	<i>63</i>
<i>Figure 10.1 – Typical Pervious Pavement Cross Section .....</i>	<i>69</i>
<i>Figure 11.2 - Pervious Pavement System Cross Section #1 .....</i>	<i>75</i>
<i>Figure 11.3 - Pervious Pavement System Cross Section #2 .....</i>	<i>76</i>
<i>Figure 11.4 – Typical Pervious Pavement System Cross Section .....</i>	<i>77</i>
<i>Figure 11.5 Plan View of ERIK In-Situ Infiltrometer .....</i>	<i>78</i>
<i>Figure 11.6 ERIK Measuring Tube .....</i>	<i>79</i>
<i>Figure 11.7 Pervious Pavement Site Plan.....</i>	<i>80</i>
<i>Figure 11.8 Pervious Pavement Site Plan.....</i>	<i>81</i>
<i>Figure 11.9 Pervious Pavement Site Plan.....</i>	<i>82</i>
<i>Figure 12.1a Extensive Greenroof Section (Usually Passive Function) .....</i>	<i>84</i>
<i>Figure 12.1b Intensive Greenroof Section (Usually Active Function.....</i>	<i>84</i>
<i>Figure 13.1 Typical Cross Section of a Wet Detention System .....</i>	<i>110</i>

<i>Figure 13.2 Removal Efficiency of Total Phosphorus in Wet Detention Ponds as a Function of Residence Time.....</i>	<i>111</i>
<i>Figure 13.3 Removal Efficiency of Total Nitrogen in Wet Detention Ponds as a Function of Residence Time.....</i>	<i>112</i>
<i>Figure 13.4a Typical Wet Detention Outfall Structure (N.T.S.).....</i>	<i>115</i>
<i>Figure 13.5 Typical Wet Detention Outfall Structure with "V"-notch Weir (N.T.S.) .....</i>	<i>116</i>
<i>Figure 13.6 Typical Wet Detention Outfall Structure With and Without Baseflow Conditions (N.T.S.) .....</i>	<i>116</i>
<i>Figure 13.7 Examples of Good and Poor Wet Detention Pond Configurations (N.T.S.) .....</i>	<i>117</i>
<i>Figure 15.1 Typical Cross Section of a Stormwater Harvesting System.....</i>	<i>130</i>
<i>Figure 15.2 Schematic for a Typical Stormwater Harvesting Pond(from FDOT BD 521-03, Regional Stormwater Facilities, December 2007).....</i>	<i>131</i>
<i>Figure 15.3 Example Schematic for Stormwater Harvesting Withdrawal System.....</i>	<i>132</i>
<i>Figure 15.4 REV Curve for Meteorological Region 1 .....</i>	<i>134</i>
<i>Figure 15.5 REV Curve for Meteorological Region 2.....</i>	<i>135</i>
<i>Figure 15.6 REV Curve for Meteorological Region 3.....</i>	<i>135</i>
<i>Figure 15.7 REV Curve for Meteorological Region 4.....</i>	<i>136</i>
<i>Figure 15.8 REV Curve for Meteorological Region 5.....</i>	<i>136</i>
<i>Figure 17.1 Cross-section of Underdrain System (N.T.S.).....</i>	<i>141</i>
<i>Figure 17.2 Top View of Underdrain System (N.T.S.) .....</i>	<i>143</i>
<i>Figure 21.1 Ground Water Mounding Beneath a Retention System.....</i>	<i>164</i>
<a href="#"><u><i>Figure 22.3-1 Cascading Dry Retention Basin Series Example. ....</i></u></a>	<a href="#"><u><i>176</i></u></a>
<i>Figure 22.3-1 Cascading Dry Retention Basin Series Example. ....</i>	<i>176</i>
<i>Table 22.3-1 Dry Retention Treatment Effectiveness for Parallel BMPs.....</i>	<i>177</i>
<i>Table 22.3-2 Dry Retention Treatment Effectiveness for BMPs in Series.....</i>	<i>177</i>
<i>Figure 25.4 -1 Cascading Wet Detention Pond Example.....</i>	<i>191</i>
<i>Figure 25.4-2 Relationship Between Detention Time and Total Phosphorus Removal in Wet Ponds .....</i>	<i>195</i>
<i>Figure 30.1. Generalized Geologic Section in Sensitive Karst Area with Limestone at and near Land Surface .....</i>	<i>205</i>
<i>Figure 30.2. Retention Basin Added to Figure 30.1.....</i>	<i>205</i>
<i>Figure 30.3. Potential Sinkhole Resulting from Change in Physical Conditions Due to Constructed Retention Basin Depicted in Figure 30.2 .....</i>	<i>206</i>

**NOTE TO READERS AND REVIEWERS: While the DEP-WMD Stormwater Rule team is seeking comments on the entire draft Applicant's Handbook, there are several areas that are highlighted in yellow for which we are especially seeking comments or alternatives.**

## **PART I – GENERAL CRITERIA**

### **1.0 Introduction**

Chapter 62-347, F.A.C., entitled “Stormwater Treatment Systems,” provides statewide regulatory criteria for stormwater treatment systems which are designed and constructed to control stormwater pollutant loads. Stormwater treatment systems usually are components of a surface water management system. Together these systems may incorporate methods to collect, convey, store, absorb, inhibit, treat, use or reuse water to prevent or reduce flooding, overdrainage, environmental degradation and pollution, or otherwise affect the quality and quantity of discharges.

The regulation of stormwater treatment systems is established pursuant to Chapter 373, F.S. This rule is a technology-based rule which includes all of the following components:

- (a) Performance standards (the minimum level of treatment for nutrients);
- (b) Design criteria for best management practices (BMPs) used to treat stormwater;
- (c) A presumption that a stormwater treatment system designed in compliance with the BMP design criteria within this rule will not cause or contribute to violations of surface water standards in chapters 62-4, and 62-302, F.A.C., and ground water standards in chapters 62-520, 62- 522, and 62-550, F.A.C., including any antidegradation provisions of sections 62-4.242(1)(a) and (b), 62-4.242(2) and (3), and 62-302.300, F.A.C., and any special standards for Outstanding Florida Waters and Outstanding National Resource Waters set forth in sections 62-4.242(2) and (3), F.A.C. For the purposes of this rule, nutrients (total nitrogen and total phosphorus) will serve as a surrogate pollutant. It is assumed that treatment efficiencies attained for nutrients will be sufficient to adequately treat other pollutants that would otherwise cause or contribute to water quality violations.

### **1.1 Applicability**

This Handbook applies to the design of stormwater treatment systems authorized pursuant to Chapter 373, F.S., that do not serve agricultural or silvicultural activities. Stormwater treatment systems are further defined in **Section 2** of this Handbook.

### **1.2 Off-site Stormwater Treatment**

Off-site stormwater treatment may be used when on-site treatment is not sufficient to meet the required performance standards. The following criteria must be met when using off-site treatment:

- (a) The off-site area must discharge to the same waterbody as the proposed project;

- (b) The applicant shall use modeling, loading calculations, or other data analysis techniques to provide reasonable assurance that the off-site treatment system provides the required stormwater treatment; and
- (c) A perpetual off-site treatment easement over the area being used for treatment shall be provided using **Form XYZ** to allow perpetual access, operation, maintenance, and repair of the off-site treatment area by the permit holder. An equivalent legal instrument may be allowed if necessitated by site specific conditions.

### **1.3 Best Management Practices (BMP) Treatment Train Nutrient Reduction Credits**

It is frequently desirable that stormwater treatment systems be designed to include a combination of BMPs in series to achieve the required pollutant removal efficiency. This concept is called the “BMP Treatment Train”. However, treatment efficiencies of BMPs in series must account for the reduced loading transferred to subsequent downstream treatment devices. After treatment occurs in the first system, a load reduction has occurred which is a function of the type of BMP used to provide treatment. After load reduction in the initial BMP, the remaining load consists of pollutant mass which was not removed. This mass is then treated by the second BMP with the nutrient reduction efficiency determined by the particular type of BMP used.

As stormwater pollutant concentrations are reduced in each BMP in the treatment train, the ability of a BMP to further reduce stormwater pollutant concentrations and loads is reduced. The treatment efficiency used for downstream BMPs must account for the diminishing effectiveness of stormwater treatment. Examples of how to calculate the overall pollutant load reduction effectiveness of a BMP Treatment Train, including where there are multiple inflow locations, are contained in the Design Example sections of this Handbook. Additionally, examples are provided in the Design Example sections when multiple wet ponds and multiple dry retention basins are used in series.

### **1.4 Alternative Designs**

An applicant may propose alternative designs to the presumptive BMP design criteria provided in this Handbook. Alternative designs will be considered by the Agency in determining whether, based on plans, monitoring data, test results, or other information, that the alternative design is necessary for the specific site conditions, and provides equivalent treatment to that required by the performance standards in this Handbook. In otherwise determining whether reasonable assurance has been provided for compliance with this paragraph, the Agency shall consider:

- (a) Whether the proposed system will provide the level of treatment required by the performance standards in this Handbook; and
- (b) Whether reasonable provisions have been made to ensure that the system will be effectively operated and maintained.

### **1.5 Inspection and Recertification of Stormwater Treatment Systems**

**Issue: The DEP-WMD stormwater team will be focusing over the next few months on how to best address OM of stormwater treatment systems. We are seeking input on the frequency of inspections, the requirements for inspections, the frequency of recertifying whether a stormwater treatment system is operating as designed and permitted, and whether the recertification forms should be submitted to the Agency or retained by the permittee. Also see Section 32 of this Handbook.**

All stormwater treatment systems shall be inspected by the permittee on a regular basis as set forth in this Handbook for each of the individual BMPs to assure that it continues to function as permitted. In addition to the regular inspections required by each BMP, the permittee shall employ a registered professional to inspect the stormwater treatment system permitted under Chapter 62-347, F.A.C., and to submit a report describing the results of the inspection and recertifying that the stormwater treatment system is operating as designed and permitted as set forth in the table below. A report shall also be submitted to the Agency within 30 days of inspection, a system failure, or deviation from the permit. The results of all such inspections shall be filed with the Agency using Form 62-347.xyz, "Operation and Maintenance Inspection Certification." Inspection frequency can be modified as set forth in a permit or for systems within Sensitive Karst Areas.

**Table 1.1 Stormwater Treatment System Recertification Frequency**

<b>TYPE OF STORMWATER TREATMENT SYSTEM</b>	<b>DURING THE FIRST TWO YEARS OF OPERATION</b>	<b>AFTER THE FIRST TWO YEARS OF SUCCESSFUL OPERATION</b>
Retention basins	Annually	Once every 5 years
Exfiltration trenches	Annually	Once every 18 months? 24 months?
Underground retention	Annually	Once every 18 months? 24 months?
Underground vault/chambers	Annually	Once every 18 months? 24 months?
Swales	Annually	Once every 5 years
Vegetated Natural Buffers	Annually	Once every 18 months? 24 months?
Pervious pavements	Annually	Once every 18 months? 24 months?
Greenroof/cisterns	Annually	Once every 18 months? 24 months?
Wet detention basins	Annually	Once every 5 years
Managed aquatic plant systems	Annually	Once every 18 months? 24 months?
Stormwater harvesting	Annually	Once every 18 months? 24 months?
Wetland treatment trains	Annually	Once every 5 years
Underdrain filtration	Annually	Once every 18 months? 24 months?
Low impact design	Annually	Once every 18 months? 24 months?
Alum injection	Annually	Once every 18 months? 24 months?

All copies of plans and drawings, together with supporting calculations and documentation submitted to the Agency must be signed, sealed, and dated by a registered professional, as required by Chapters 471, 472, 481 or 492, F.S., as applicable, when the design of the system requires the services of a registered professional.



## PART II – DEFINITIONS

### 2.0 Definitions

In the event of conflicts with other rules of the Department or water management districts related to stormwater quality, when applied to the design and permitting of stormwater treatment systems, the definitions in Sections 373.019, 373.403, 403.031, and 403.803, F.S, Chapter 62-347, F.A.C, and this Handbook will control. For the user’s convenience, many of these definitions which are relevant to the design of stormwater treatment systems are included in Appendix A.

- (1) “Agency” or “responsible agency” means the Department of Environmental Protection or a water management district established under Section 373.069, F.S., including any local governments delegated to implement the rules adopted under Part IV of Chapter 373, F.S., in accordance with Section 373.441, F.S.
- (2) “Confining unit” means a strata or layer of clay, hardpan, organic mucks, or other material that restrict the movement of water below that strata or layer.
- (3) “Control elevation” means the lowest elevation at which water can be released through a control device.
- (4) “Detention” means the collection and temporary storage of stormwater with subsequent gradual release of the stormwater.
- (5) “Directly connected impervious area,” or “DCIA” means the area covered by a building, impermeable pavement, and/or other impervious surfaces, which drains directly into the conveyance without first flowing across sufficient permeable vegetated land area to allow for infiltration of runoff.
- (6) “Discharge” means to allow or cause water to flow to receiving waters or off-site properties.
- (7) “Existing land use” means the land uses that exist on the project site as of the effective date of this Handbook.
- (8) “Hydrologic Unit Code” or “HUC” means the hydrologic cataloging unit assigned to a geographic area representing a surface drainage basin.
- (9) “Impervious” means land surfaces that do not allow, or minimally allow, the penetration of water; such as building roofs, non-porous concrete and asphalt pavements, and some fine grained or compacted soils.
- (10) “Littoral zone” means that portion of a wet detention pond that is designed to contain rooted aquatic plants.
- (11) “Natural vegetative community type” means the landscape that currently exists or is likely to have existed prior to disturbance based on the vegetation community associated with the natural soil type of the project area, using information such as soil surveys, aerial photographs, and the vegetation communities that can reasonably be expected to have existed on the site before disturbance.
- (12) “Net improvement” means the performance standard for treating stormwater wherein the pollutant loads discharged from the existing land use of the project area are reduced.
- (13) “Off-line” means the storage of a specified volume of stormwater so that subsequent runoff in excess of the specified volume does not flow into the BMP storing the initial volume of stormwater.
- (14) “Operate” or “operation” means to cause or to allow a system to function.
- (15) “Pre-development” means the natural vegetative community type of the project area.
- (16) “Post-development” means the land use on the project area that will exist after the project is completed.
- (17) “Permanent pool” means that portion of a wet detention pond that holds water between the normal water level and the top of the anoxic zone excluding any water volume claimed as wet detention bleeddown volume.

- (18) “Post equals pre” or “post = pre” means the performance standard for treating stormwater in which the post-development average annual loading of total phosphorus and nitrogen does not exceed the loading from natural vegetative community types.
- (19) “Project area” means the area being modified or altered in conjunction with an activity requiring a permit.
- (20) “Redevelopment” means the construction of a stormwater treatment system on sites having existing commercial, industrial, institutional, or multi-family land uses where the existing impervious surface will be removed as part of the proposed activity.
- (21) “Registered professional” means a professional registered or licensed by and in the State of Florida and who possesses the expertise and experience necessary for the competent preparation, submittal and certification of documents and materials, and performing other services required in support of permitting, constructing, altering, inspecting, and operating a proposed or existing activity regulated under Part IV of Chapter 373, F.S. Examples of registered professionals, authorized pursuant to Chapter 455, F.S., and the respective practice acts by which they are regulated, are professional engineers licensed under Chapter 471, F.S., professional landscape architects licensed under Chapter 481, F.S., professional surveyors and mappers under Chapter 472, F.S., and professional geologists licensed under Chapter 492, F.S.
- (22) “Retention” means a stormwater treatment system designed to prevent the discharge of a given volume of stormwater runoff into surface waters by complete on-site storage of that volume.
- (23) “Soil Survey” means a document prepared by the U.S. Natural Resources Conservation Service that provides soil maps and interpretations useful for guiding decisions about soil selection, use, and management.
- (24) “Stormwater harvesting” means the beneficial use of treated stormwater to reduce the volume of stormwater and the associated pollutant load discharged from a stormwater treatment system, but specifically does not include reclaimed water as defined in Chapter 62-610, F.A.C.
- (25) “Seasonal high ground water table” (SHGWT) means the zone of water saturated soil at the highest average depth during the wettest season of the year during periods of normal rainfall, based upon site specific factors described in Section 21 of this Handbook.
- (26) “Sensitive karst areas” means those areas described in Section 30 and **Appendix G** of this Handbook, where the Floridan aquifer is at or near the land surface.
- (27) “Stormwater treatment system” means a system which is designed and constructed or implemented to reduce the discharge of pollutants in stormwater by incorporating methods to collect, convey, store, absorb, treat, use, or reuse stormwater.

## PART III – STORMWATER QUALITY PERMITTING REQUIREMENTS

### 3.1 Performance Standards

**Issue: What is the appropriate performance standard to assure that nutrients in stormwater discharges do not cause or contribute to violations of nutrient criteria, either individually or cumulatively? Since the post-development total phosphorus loading increases by a factor of about 10 above predevelopment loading and that total nitrogen post-development loading increases by a factor of about 4, should there be one performance standard for TP and a different one for TN? If so, what should they be?**

A stormwater treatment system shall be designed to meet the following performance standards (the minimum level of treatment):

- (a) Except as provided below, all stormwater treatment systems shall provide a minimum level of treatment sufficient to accomplish the lesser of the following:
  - (i) an 85% reduction of the post-development average annual loading of nutrients from the project; or,
  - (ii) a reduction such that the post-development average annual loading of nutrients do not exceed the nutrient loading from the project area's natural vegetative community types. (See Chapter 6 of the 2007 report "Evaluation of Current Stormwater Design Criteria within the State of Florida" for information on the amount of load reduction required to achieve post=pre).
- (b) Stormwater treatment systems for activities within drainage basins defined by the 12 unit HUC of an Outstanding Florida Waters shall provide a minimum level of treatment that results in a reduction such that the post-development average annual loading of nutrients do not exceed the nutrient loading from the project area's natural vegetative community types (post=pre). **The 12-unit HUC maps are available at: TO BE ADDED**
- (c) Stormwater treatment systems serving redevelopment activities that occur on lands with two or less acres shall meet the appropriate minimum level of treatment set forth above. However, an applicant may request approval by the Agency of a lower level of treatment. The lower level of treatment will be determined by the applicant conducting and submitting a feasibility analysis which considers the applicability of currently available treatment technologies relative to:
  - The current and proposed land use and level of imperviousness
  - Physical site constraints such as soil and water table characteristics
  - Hydraulic constraints such as tailwater elevations
  - Connections to existing infrastructure
  - Local government requirements (zoning, land use intensity, codes)
  - Availability of regional facilities and opportunities for offsite treatmentThe Agency shall review the feasibility analysis and determine the final level of treatment that will be required for the activity.
- (d) Stormwater treatment systems for activities within drainage basins defined by the 12-unit HUC of a water body that does not meet water quality standards, including waters on the adopted Verified List of Impaired Waters, or for which a Total Maximum Daily Load (TMDL) or a Basin Management Action Plan (BMAP) has been adopted, shall provide:
  - (i) the level of stormwater treatment required in (a), (b), or (c) above, as applicable, and

- (ii) the greater of:
  - a. net improvement for the pollutant that is not meeting water quality standards, or
  - b. the percent reduction specified in an adopted TMDL or BMAP for the pollutant that is not meeting water quality standards.

Table 3.1 summarizes the Performance Standards in this rule.

**Table 3.1 Stormwater Treatment Performance Standards**

NON-OFWs	OFWs	IMPAIRED WATERS	IMPAIRED WATERS WITH ADOPTED TMDL OR BMAP
<p><b>REDEVELOPMENT SITES ≤ 2 ACRES</b></p> <p>85% or Post=Pre, whichever is less unless feasibility analysis demonstrates lower level is appropriate</p>	<p><b>REDEVELOPMENT SITES ≤ 2 ACRES</b></p> <p>Post=Pre, unless feasibility analysis demonstrates lower level is appropriate</p>	<p><b>REDEVELOPMENT SITES ≤ 2 ACRES</b></p> <p>85% or Post=Pre, whichever is less unless feasibility analysis demonstrates lower level is appropriate AND Net improvement for pollutant not meeting water quality standards</p>	<p><b>REDEVELOPMENT SITES ≤ 2 ACRES</b></p> <p>85% or Post=Pre, whichever is less unless feasibility analysis demonstrates lower level is appropriate AND Net improvement or TMDL/BMAP % reduction, whichever is greater, pollutant not meeting water quality standards</p>
<p><b>ALL OTHER ACTIVITIES</b></p> <p>85% or Post=Pre, Whichever is less</p>	<p><b>ALL OTHER ACTIVITIES</b></p> <p>Post = Pre</p>	<p><b>ALL OTHER ACTIVITIES</b></p> <p>85% or Post=Pre, Whichever is less, or, if the water body is an OFW Post=Pre AND in either case net improvement for the pollutant not meeting water quality standards</p>	<p><b>ALL OTHER ACTIVITIES</b></p> <p>85% or Post=Pre, Whichever is less, or, if the water body is an OFW Post=Pre AND in either case net improvement or TMDL/BMAP % reduction, whichever is greater, for the pollutant not meeting water quality standards</p>

A showing by the applicant that a stormwater treatment system complies with the applicable BMP design criteria in Part IV of this Handbook, shall create a rebuttable presumption that the applicant has provided reasonable assurance that the proposed activity meets the requirements in Section 3.1 (a) through (d), above.

Alternatively, an applicant can provide site-specific information to demonstrate that total phosphorus and total nitrogen loadings discharged to waters do not have the potential, either individually or cumulatively with all other existing and reasonably anticipated projects and pollutant sources in the basin, to cause or contribute to water quality violations in the basin. When an applicant affirmatively demonstrates that nutrient discharges do not have the potential to cause or contribute to water quality violations in the basin, the applicant may propose an alternative treatment level that will reduce the annual nutrient loading such that the discharge will not cause or contribute to violations of state water quality standards, now or in the future.

### **3.2 *Additional Permitting Requirements to Protect Ground Water***

State water quality standards for ground water are set forth in Chapter 62-520, F.A.C. In addition to the minimum criteria, Class G-I and G-II ground water must meet primary and secondary drinking water quality standards for public water systems established pursuant to the Florida Safe Drinking Water Act, which are listed in Rules 62-550.310 and 62-550.320, F.A.C.

Only the minimum criteria apply within a zone of discharge, as determined by Rule 62-520.400, F.A.C. A zone of discharge is defined as a volume underlying or surrounding the site and extending to the base of a specifically designated aquifer or aquifers, within which an opportunity for the treatment, mixture or dispersion of wastes into receiving ground water is afforded. Generally, stormwater systems have a zone of discharge 100 feet from the system boundary or to the project's property boundary, whichever is less.

Stormwater retention and detention systems are classified as moderate sanitary hazards with respect to public and private drinking water wells. Accordingly, stormwater treatment facilities shall not be constructed within 50 feet of a public or private drinking water supply well.

To assure protection of ground water quality, all stormwater treatment systems shall be designed and constructed to:

- (1) Assure adequate treatment of stormwater before it enters any aquifer system used for potable water supply such that no violation of ground or drinking water standards exist outside the authorized Zone of Discharge (the property boundary).
- (2) Avoid breaching an aquitard that will allow direct mixing of untreated water between surface water and an aquifer system used for drinking water. Where an aquitard is not present, the depth of the stormwater treatment system shall be limited to prevent any excavation within three (3) feet of the underlying limestone which is part of a drinking water aquifer.

### **3.3 *Calculating Required Nutrient Load Reduction***

To determine the required stormwater nutrient load reduction for a project, the following steps should be undertaken:

- Determine the type of water body to which the stormwater will discharge and select the appropriate performance standard from **Section 3.1** of this Handbook.
- Calculate the project's post-development nutrient loading without treatment for both TN and TP.
- Calculate the required level of TP load reduction, either 85% or "post=pre", as appropriate.

- Determine which BMPs will be used to meet the required TP load reductions. Information on the nutrient load reduction credits for individual BMPs is provided in Part IV of this Handbook. Information on how to calculate nutrient load reduction credits for BMP Treatment Trains is found in **Section 1.3** and **Part V** of this Handbook.
- Determine the percent TN reduction needed to meet the “post=pre” load reductions. Compare the percent reduction to see which is less, 85% or “post=pre”. (Note: The TN load percent reduction to meet “post=pre” varies from approximately 55% to 99%).
- Calculate the percent TN reduction that will occur from the BMPs used to obtain the required TP load reduction.
- Determine if the BMPs used to obtain the required TP load reduction will achieve the required level of TN load reduction. If it does, complete the design of your stormwater treatment system. If it does not, add BMPs to increase the TN reduction until it meets the required amount of load reduction.

Pre- and post-development loadings are calculated, and subsequently compared, based on the annual mass of total phosphorus and total nitrogen discharged. The required treatment efficiency in percent reduction is calculated based on the equation:

**Equation 3-1: Required % reduction =**

$$\left( 1 - \left( \frac{\text{Predevelopment Loading [kg/yr]}}{\text{Postdevelopment Loading [kg/yr]}} \right) \right) \times 100$$

The specific method for calculating pre and post-development loadings is described in **Sections 3.4** and **3.5** of this Handbook.

### **3.4** *Calculating Pollutant Loading for Natural Vegetative Community Types (pre-development)*

The methodology for calculating site-specific annual pollutant loadings from natural vegetative community types is provided herein and shall be used with results from **Section 3.5** for calculation of specific post-development annual loadings. Required treatment efficiencies are then calculated using **Equation 3-1**.

#### **3.4.1** *Determining Vegetative Community Types and Associated Areal Loading Rates (pre-development)*

Natural vegetative community types are assigned areal loading rates for total nitrogen and total phosphorus as provided in **Table 3.2**. Natural vegetative community types that exist at the project site (for undisturbed sites) or that would have existed at the site (for disturbed sites) will be determined by association with soil types as determined in **Appendix B**. The following steps shall be taken to determine the natural vegetative community types at a project site:

- Determine the soil series that exist on the site.
- Use the table in **Appendix B** to identify the vegetative community types associated with the project site’s soils. From the vegetative community or communities listed for the site’s soil, select the TN and TP Vegetative Community Groups appropriate for the vegetative community or communities at the project site.

- Using **Table 3.2**, determine the appropriate TP and TN areal loading rates for the Vegetative Community Groups identified above.
- Wetlands are excluded from loading calculations in both the pre-development and post-development conditions.

An applicant may propose to use locally collected TN and TP areal loading rates instead of those shown in **Table 3.2** when it can be affirmatively demonstrated that they were collected using stormwater monitoring techniques consistent with those used in the studies from which the area loading rates in **Table 3.2** were obtained.

**Table 3.2 Natural Vegetative Community Areal Loading Rates**

METEROLOGICAL ZONE	TP LOAD (kg/ac-inch-yr)		TN LOAD (kg/ac-inch-yr)	
	Group 1	Group 2	Group 1	Group 2
1	0.00025	0.00372	0.00131	0.01199
2	0.00015	0.00226	0.00064	0.00769
3	0.00023	0.00333	0.00141	0.00978
4	0.00016	0.00236	0.00080	0.00752
5	0.00027	0.00396	0.00157	0.01217

### 3.4.2 Calculating Predevelopment Pollutant Loadings

Predevelopment annual mass loadings for total phosphorus and total nitrogen are calculated by multiplying the TP and TN areal loading rates for the natural vegetative community types times the number of acres of each vegetative community type times the mean annual rainfall for the rainfall zone in which the project site is located (**Figure 3.2**). This is shown in the equation below:

#### Equation 3-2

**Predevelopment Loading =**  
**TN or TP areal loading rate (kg/ac-inch-yr) \* Size of Vegetative Community Types (acres) \***  
**Annual Rainfall (inches/yr)**

### 3.5 Calculation of Post-Development Loading

The methodology for calculating site-specific post-development annual pollutant loadings is provided herein and shall be used along with results from **Section 3.4** in which predevelopment annual loadings were calculated. However, other continuous simulation methods such as EPA SWMM may also be used to calculate post-development hydrology and loadings. Required treatment efficiencies are then calculated using **Equation 3-1**.

#### 3.5.1 Calculation of Post-Development Hydrology

For the purposes of this Handbook, estimates of annual runoff volumes shall be performed using the method described herein or another methodology based on continuous simulation modeling such as EPA SWMM. The Handbook's methodology provides tabular solutions to a series of calculations for determining annual runoff volumes for each of the State's designated meteorological regions or zones as indicated in **Figure 3.1**. A listing of the counties included in each meteorological zone is given in **Table 3-3**.

A summary of calculated mean annual runoff coefficients (“C value”) as a function of curve number and DCIA is given in **Appendix E** for each of the five designated meteorological zones. The values summarized in **Appendix E** reflect the average long-term runoff coefficients (C Values) for each of the five designated zones over a wide range of DCIA and curve number combinations.

For the purposes of this section, the information contained in **Appendix E** is used to estimate the annual runoff volume for a given parcel under either pre- or post-development conditions by multiplying the mean annual rainfall depth for the given area obtained from **Figure 3.2**, times the appropriate runoff coefficient (C value) based upon the DCIA and curve number characteristics for the meteorological zone in which the parcel is located, listed in **Appendix E** as follows:

**Annual Runoff Volume (ac-ft) =**

$$\text{Area (acres)} \times \text{Mean Annual Rainfall (inches)} \times \text{C Value} \times \frac{1 \text{ ft}}{12 \text{ in}}$$

Linear interpolation can be used to estimate annual runoff coefficients for combinations of DCIA and curve numbers which fall between the values included in **Appendix E**.

For “naturally occurring” undeveloped conditions, it should be assumed that the percent DCIA is equal to 0.0.

### 3.5.2 Calculation of Post-Development Loading

The post-development annual mass loadings of total phosphorus and total nitrogen are calculated by multiplying the post-development annual runoff volume (derived in **Section 3.5.1**) by the land use specific runoff characterization data (event mean concentrations or EMCs) for total phosphorus and total nitrogen listed in **Table 3.4** for post-development conditions. The mass loading calculation is provided as **Equation 3-2**, below.

$$\text{Annual Mass Loading} = \text{Annual Runoff Volume} \times \text{EMC} \quad (\text{Equation 3-2})$$

The various components of **Equation 3-2** are expressed in different units and require some conversion factors, as provided below.

$$\text{Annual Mass Loading (kg/year)} = \text{Annual Runoff Volume (ac-ft/year)} \times \text{EMC (mg/l)}$$

$$\text{Annual Mass Loading (kg/year)} =$$

$$= \text{Volume (ac-ft/year)} \times 43,560 \text{ ft}^2/\text{ac} \times 7.48 \text{ gal/ft}^3 \times 3.785 \text{ liter/gal} \times \text{EMC (mg/l)} \times 1 \text{ kg}/10^6 \text{ mg}$$

Upon determining the pre- and post-development annual pollutant loadings for total nitrogen and total phosphorus, the required treatment efficiency (% reduction) is calculated using **Equation 3-1**.



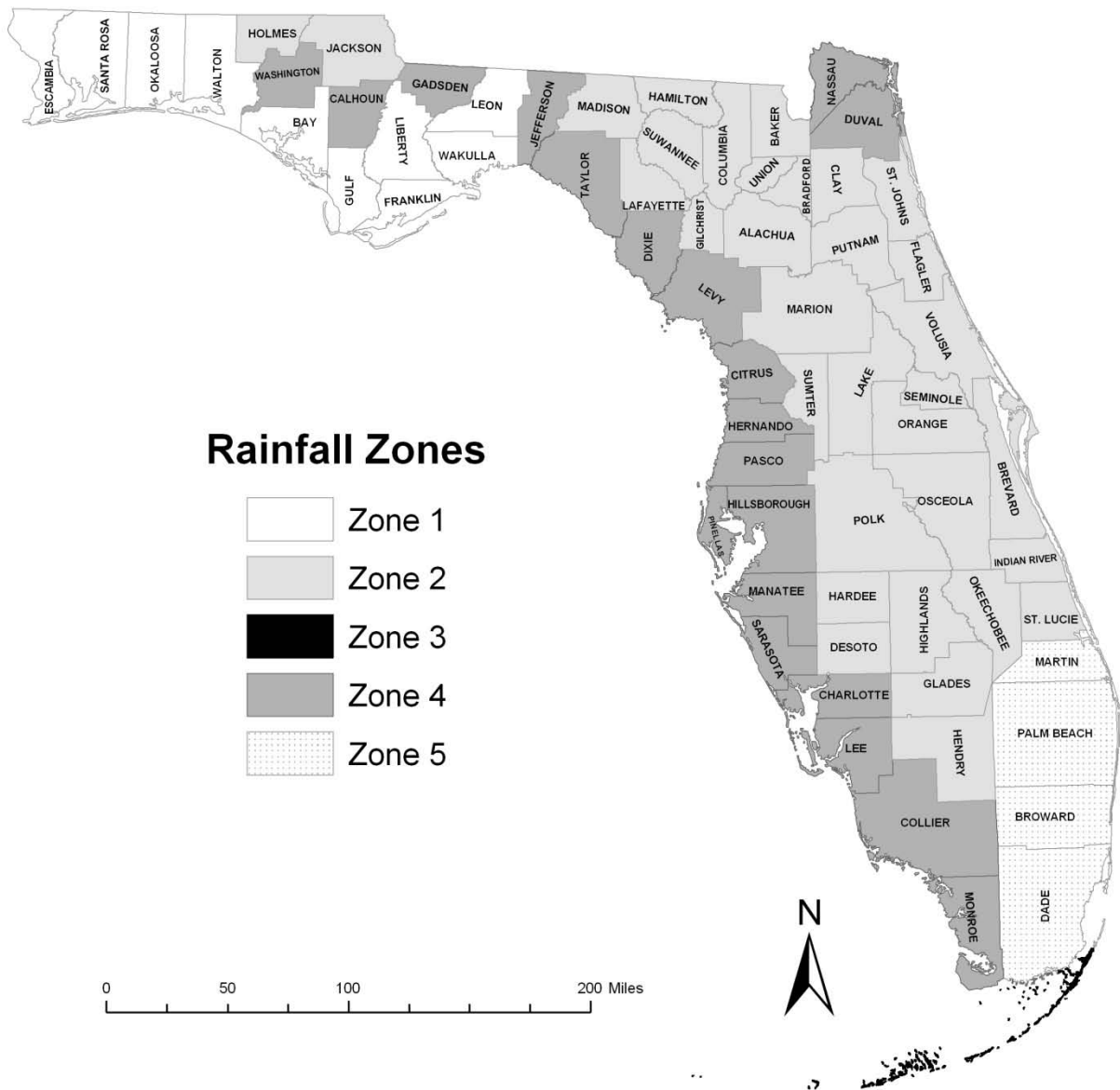

**Figure 3.1 Designated Meteorological Regions (Zones) in Florida**

**Table 3-3 Counties Included in the Designated Meteorological Zones**

<b>Meteorological Zone</b>				
<b>ZONE 1</b>	<b>ZONE 2</b>	<b>ZONE 3</b>	<b>ZONE 4</b>	<b>ZONE 5</b>
Bay Escambia Franklin Gulf Leon Liberty Okaloosa Santa Rosa Wakulla Walton	Alachua Baker Bradford Brevard Calhoun Clay Columbia Desoto Flagler Gadsden Gilchrist Glades Hamilton Hardee Hendry Highlands Holmes Indian River Jackson Lafayette Lake Madison Marion Okeechobee Orange Osceola Polk Putnam Seminole St. Johns St. Lucie Sumter Union Volusia	Monroe County - Florida Keys from Key Largo to Key West	Charlotte Citrus Collier Dixie Duval Hernando Hillsborough Jefferson Lee Levy Manatee Mainland Monroe Nassau Pasco Pinellas Sarasota Taylor Washington	Broward Miami-Dade Martin Palm Beach

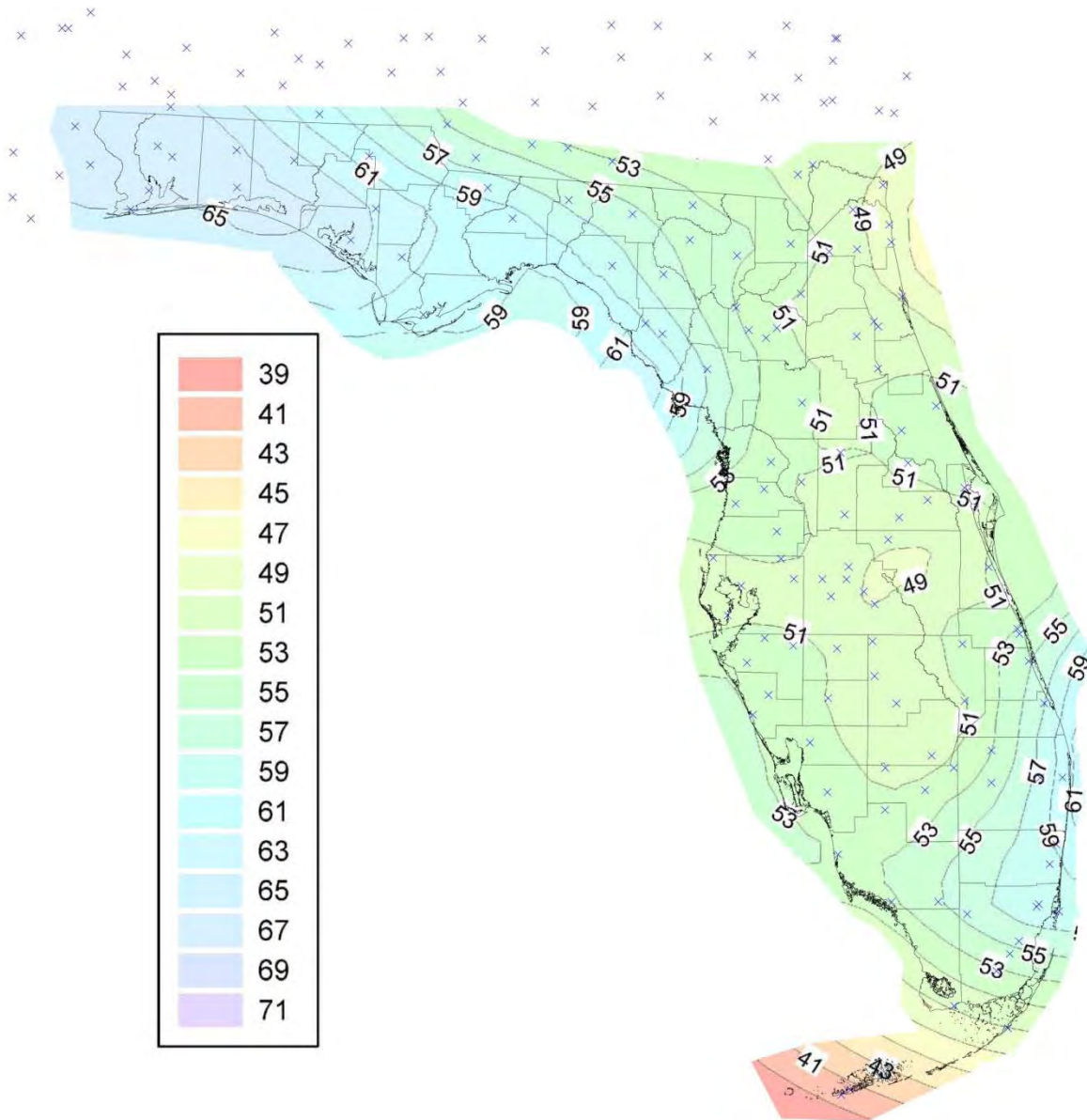

Figure 3.2 Rainfall Isopleth Map for Florida

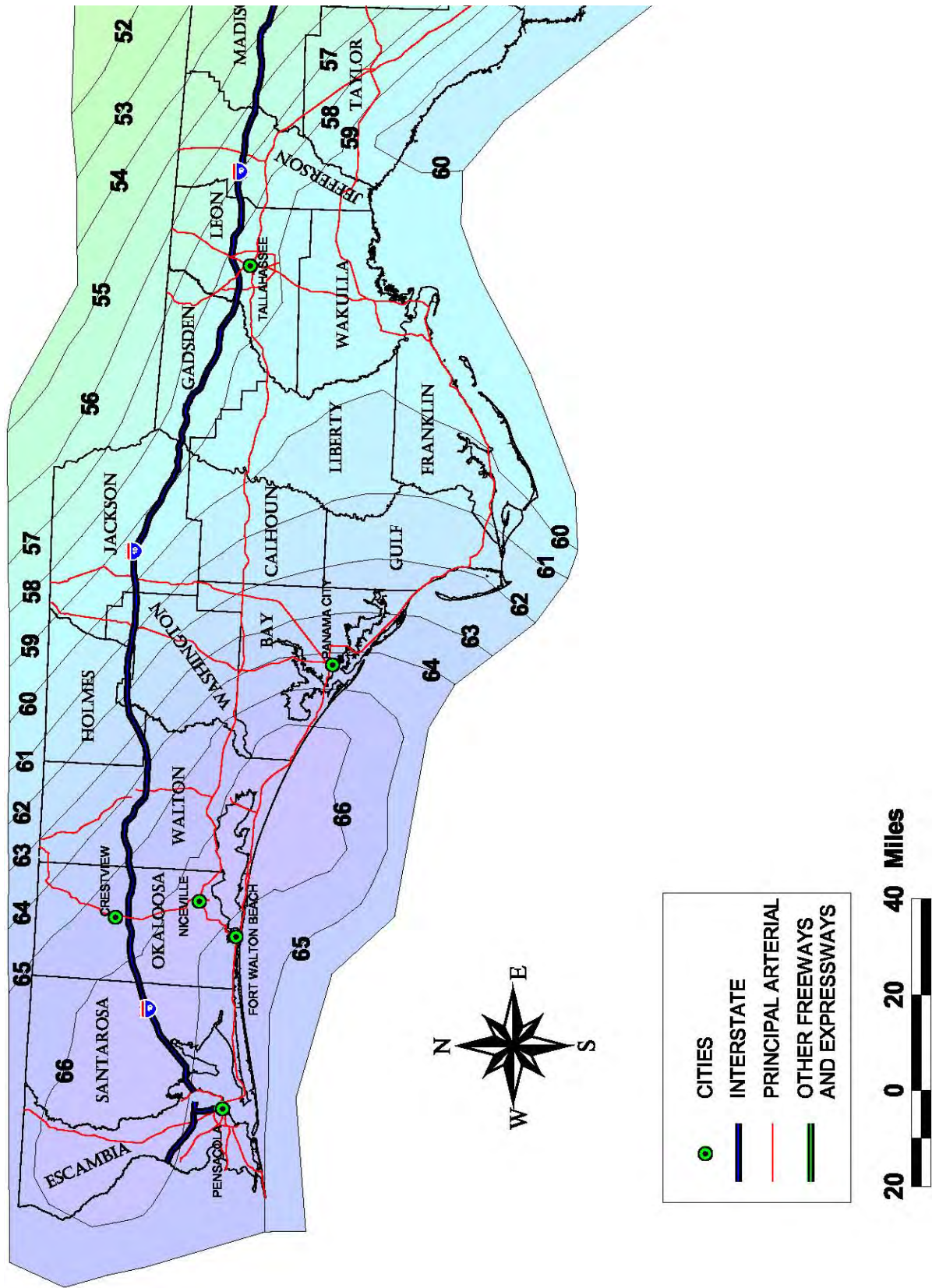

Figure 3.3 Rainfall Isopleth Map for Northwest Florida



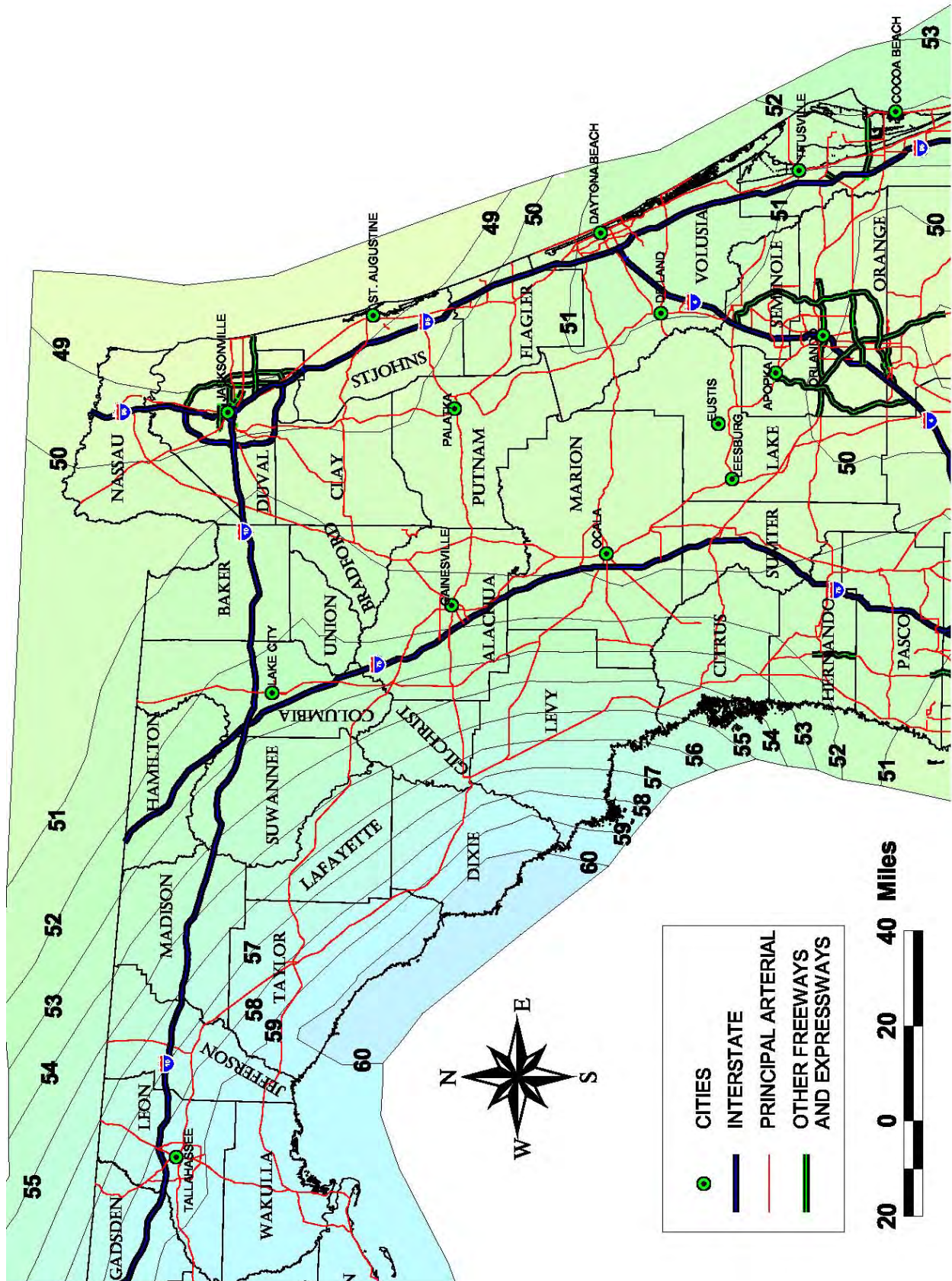

Figure 3.4 Rainfall Isopleth Map for Northeast-North Central Florida



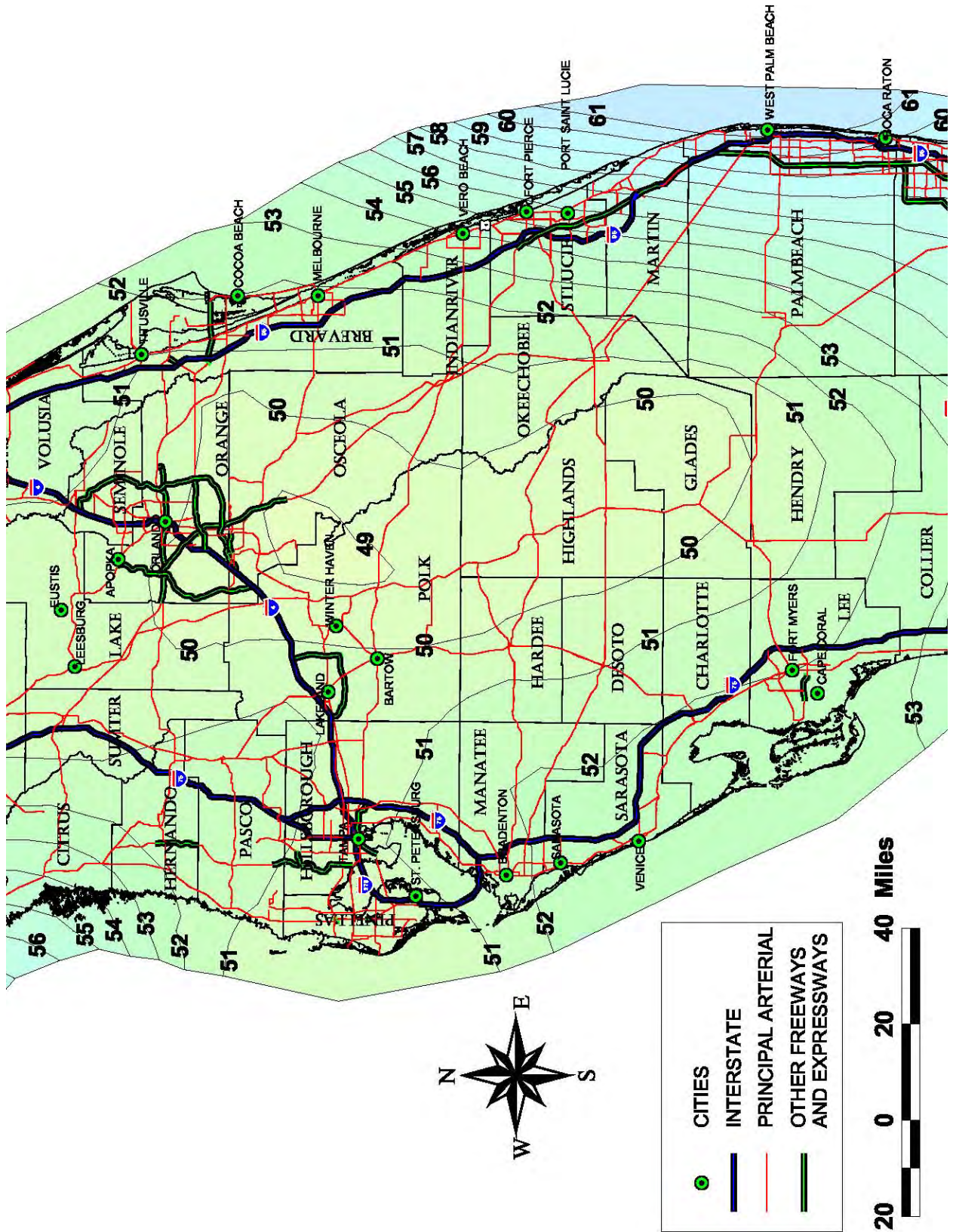

Figure 3.5 Rainfall Isopleth Map for Central Florida

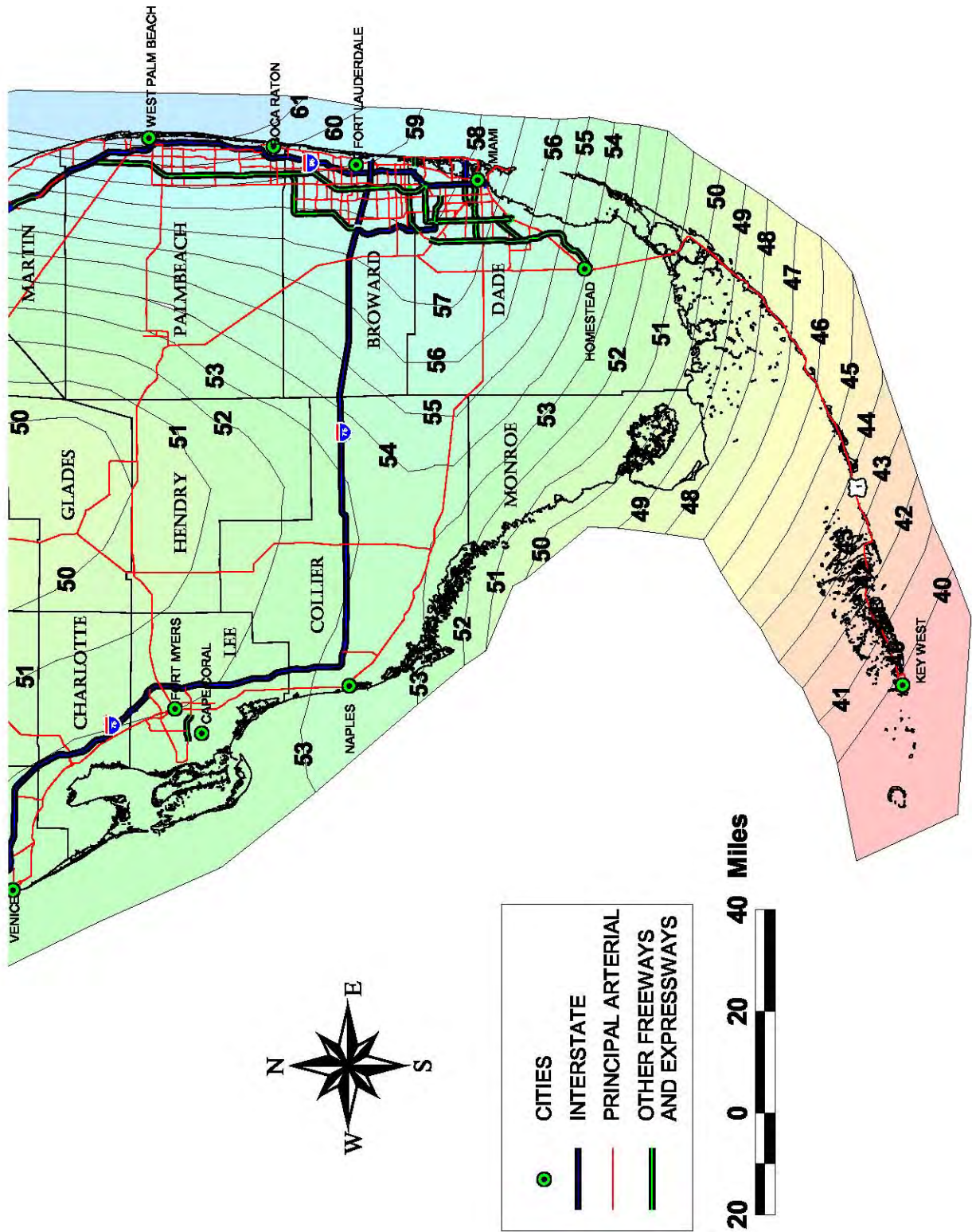

Figure 3.6 Rainfall Isopleth Map for South Florida



**Table 3.4 Summary of Literature-based Runoff Characterization Data for General Land Use Categories in Florida**

Land Use Category	Event Mean Concentration (mg/l)	
	Total Nitrogen	Total Phosphorus
Low-Density Residential <sup>1</sup>	1.50	0.18
Single-Family	1.85	0.31
Multi-Family	1.91	0.48
Low-Intensity Commercial	0.93	0.16
High-Intensity Commercial	2.48	0.23
Light Industrial	1.14	0.23
Highway	1.37	0.17
<u>Agricultural</u>		
Pasture	2.48	0.70
Citrus	2.31	0.16
Row Crops	2.47	0.51
General Agriculture <sup>2</sup>	2.42	0.46
Mining/Extractive	1.18	0.15

1. Average of single-family and undeveloped loading rates
2. Mean of pasture, citrus, and row crop land uses

For detailed descriptions of the characteristics of each of the above land use categories and the data that was used in developing **Table 3.4**, please see **Appendix C**.

### 3.6 *Oil and Grease Control*

Systems that receive stormwater from areas with impervious area that are subject to vehicular traffic must include a baffle, skimmer, grease trap or other mechanism suitable for preventing oil and grease from leaving the stormwater treatment system in concentrations that would cause a violation of water quality standards. Designs must assure sufficient clearance between the skimmer and concrete structure or pond bottom to ensure that the hydraulic capacity of the structure is not affected. A typical illustration of a skimmer on an outlet structure is shown in **Figure 3.7**.

### 3.7 *Hazardous or Toxic Substances*

Systems serving a land use or activity that produces or stores hazardous or toxic substances shall be designed to prevent exposure of such materials to rainfall and runoff to ensure that stormwater does not become contaminated by such materials. Such land uses may not be appropriate for certain BMPs such as retention basins to minimize introduction of such materials into the ground water.

### 3.8 *Off-site Stormwater*

The volume of runoff to be treated from a site shall be determined by the minimum level of treatment set forth in **Section 3.1** of this Handbook; the type of treatment system (i.e., retention, wet detention, etc.); and the meteorological region (rainfall zone) where the project is proposed. If stormwater runoff from off-site areas is allowed to co-mingle with on-site runoff, then the effects of runoff from these off-site areas must be considered in the load reduction calculations for the project site.



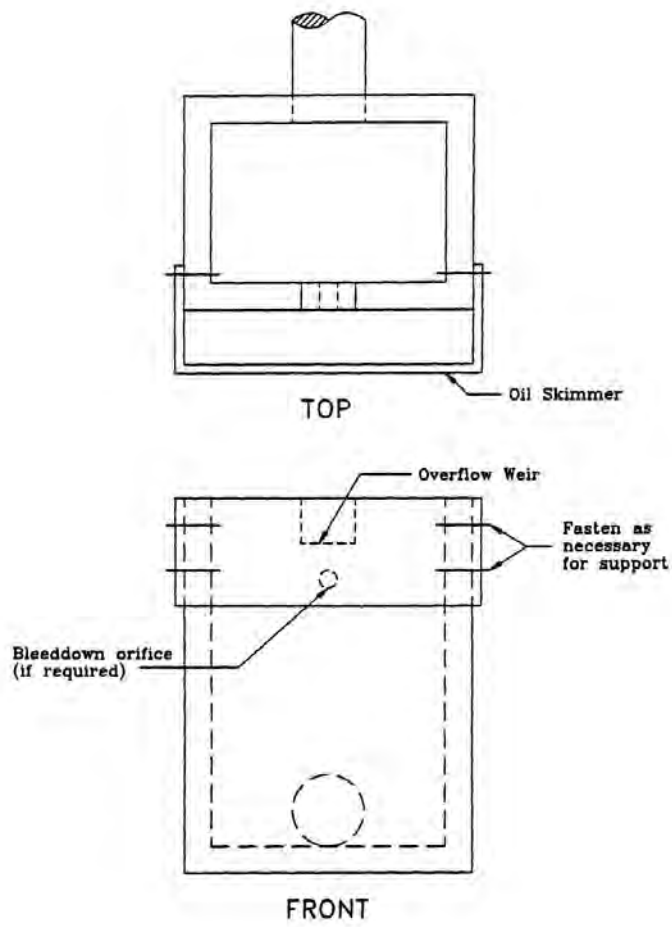

**Figure 3.7 Oil Skimmer Detail for a Typical Outfall Structure (N.T.S.)**

## PART IV – EROSION AND SEDIMENT CONTROL

### 4.0 Erosion and Sediment Control

#### 4.1 *Overview*

Uncontrolled erosion and sediment from land development activities can result in costly damage to aquatic areas and to both private and public lands. Excessive sediment blocks stormwater conveyance systems, plugs culverts, fills navigable channels, impairs fish spawning, clogs the gills of fish and invertebrates, and suppresses aquatic life.

A plan for minimizing erosion and controlling sediment through the implementation of appropriate BMPs must be included with the application for a stormwater treatment permit. The plan may be either an “erosion and sediment control plan”, as discussed in **Section 4.2** below, or a Stormwater Pollution Prevention Plan (SWPPP), as described in **Section 4.3** below.

An effective sediment and erosion control plan is essential for controlling stormwater pollution during construction. An erosion and sediment control plan is a site-specific plan that specifies the location, installation, and maintenance of best management practices to prevent and control erosion and sediment loss at a construction site. The plan is submitted as part of the permit application and must be clearly shown on the construction plans for the development. Erosion and sediment control plans range from very simple for small, single-phase developments to complex for large, multiple phased projects. If, because of unforeseen circumstances such as extreme rainfall events or construction delays, the proposed erosion and sedimentation controls no longer provide reasonable assurance that water quality standards will not be violated, additional erosion and sediment control measures shall be required that must be designed and implemented to prevent violations of water quality standards. The criteria for erosion and sediment controls are described below.

#### 4.1.1 *Erosion and Sediment Control Requirements*

Erosion and sediment control best management practices (BMPs) shall be used as necessary during construction to **retain sediment on-site and assure that any discharges from the site do not cause or contribute to a violation of Florida’s turbidity standard, which is 29 N.T.U. above background.** These management practices must be designed according to specific site conditions and shall be shown or clearly referenced on the construction plans for the development. At a minimum, the erosion and sediment control requirements described in this section shall be followed during construction of the project. Additional measures are required if necessary to protect wetlands or prevent off-site flooding. The contractor must be furnished with the information pertaining to the implementation, operation, and maintenance of the erosion and sediment control plan. In addition, sediment accumulation in the stormwater system from construction activities must be removed to prevent a loss of storage volume.

#### 4.1.2 *Erosion and Sediment Control Principles*

Factors that influence erosion potential include soil characteristics, vegetative cover, topography, climatic conditions, timing of construction, and the areal extent of land clearing activities. The following principles must be considered in planning and undertaking construction and alteration of surface water management systems:

- (a) Plan the development to fit topography, soils, drainage patterns, and vegetation;

- (b) Minimize both the extent of area exposed at one time and the duration of exposure;
- (c) Schedule activities during the dry season or during dry periods whenever possible to reduce the erosion potential;
- (d) Apply erosion control practices to minimize erosion from disturbed areas;
- (e) Apply perimeter controls to protect disturbed areas from off-site runoff and to trap eroded material on-site to prevent sedimentation in downstream areas;
- (f) Keep runoff velocities low and retain runoff on-site;
- (g) Stabilize disturbed areas immediately after final grade has been attained or during interim periods of inactivity resulting from construction delays; and
- (h) Implement a thorough maintenance and follow-up program.

These principles are usually integrated into a system of vegetative and structural measures along with other management techniques that are included in an erosion and sediment control plan to prevent erosion and control movement of sediment. In most cases, a combination of limited clearing and grading, limited time of exposure, and a judicious selection of erosion control practices and sediment trapping systems will prove to be the most practical method of controlling erosion and the associated production and transport of sediment. Permit applicants, system designers, and contractors can refer to the *State of Florida Erosion and Sediment Control Designer and Reviewer Manual (June 2007)* and the *Florida Stormwater, Erosion, and Sediment Control Inspector's Manual (FDEP 2005)*, for further information on erosion and sediment control. These manuals provide guidance for the planning, design, construction, and maintenance of erosion and sediment control practices. Copies of the *State of Florida Erosion and Sediment Control Designer and Reviewer Manual* are available from the University of Central Florida's Stormwater Management Academy's Internet site at:

[http://www.stormwater.ucf.edu/FLErosionSedimentManual\\_6\\_07.pdf](http://www.stormwater.ucf.edu/FLErosionSedimentManual_6_07.pdf). Copies of *The Florida Stormwater, Erosion, and Sediment Control Inspector's Manual* can be obtained upon request from the Florida Department of Environmental Protection, Nonpoint Source Management Section, M.S. 3570, 2600 Blair Stone Road, Tallahassee, Florida 32399-2400 (phone 850-245-7508). Copies of the above documents are also available on the Department's Internet site at: <http://www.dep.state.fl.us/water/nonpoint/erosion.htm>

#### **4.2 Development of an Erosion and Sediment Control Plan**

An erosion and sediment control plan must be submitted as part of the application as a way of providing reasonable assurance that water quality standards will not be violated. The plan must identify the location, relative timing, and specifications for all erosion and sediment control and stabilization measures that will be implemented as part of the project's construction. The plan must provide for compliance with the terms and schedule of implementing the proposed project, beginning with the initiation of construction activities. The plan may be submitted as a separate document, or may be contained as part of the plans and specifications of the construction documents.

### **4.3 Development of a Stormwater Pollution Prevention Plan (SWPPP) for NPDES Requirements**

Although the requirement to develop and submit an SWPPP under an NPDES permit is not a requirement for a permit under Part IV of Chapter 373, F.S., applicants are advised that preparation and adherence to an SWPPP is required where the permitted activity also requires a National Pollution Discharge Elimination System (NPDES) construction permit pursuant to subsection 62-621.300(4), F.A.C. Namely, **those construction activities resulting in greater than 1 acre of land clearing, soil disturbance, excavation, or deposition of dredge materials must also apply for and receive coverage under Florida's NPDES Stormwater Permitting program.** If the proposed activity requires an SWPPP for compliance with the NPDES construction permit, such a plan will generally provide the level of reasonable assurance needed as part of the review of an individual, or noticed general permit, to demonstrate that erosion and sediments will be adequately controlled during construction. Such SWPPPs must be prepared in accordance with generally accepted best management practices. An SWPPP identifies potential sources of pollution that may reasonably be expected to affect the quality of stormwater discharge associated with construction activity. In addition, an SWPPP describes and ensures the implementation of best management practices that will be used to reduce the pollutants in stormwater discharge associated with construction activities.

The details and scope of the SWPPP will depend on the potential for erosion. Projects with larger exposed areas, long duration of construction, steep slopes, erosive soils, or close proximity to streams and other watercourses generally require more detailed and comprehensive plans. The SWPPP must include consideration of the site-specific erosion potential, including slopes, soil erodibility, vegetative cover, and runoff characteristics.

#### **4.3.1 Contents of an SWPPP**

**Sections 4.3.1.1 through 4.3.1.4** are excerpted from the requirements for a NPDES construction generic permit (<http://www.dep.state.fl.us/water/stormwater/npdes/docs/cgp.pdf>) and are provided here for the convenience of the reader. A SWPPP, as described in **Section 4.3**, that contains the elements discussed in **Sections 4.3.1.1 through 4.3.1.4**, below, will generally provide the reasonable assurance that turbidity, sedimentation, and erosion can be controlled during implementation of the project.

##### **4.3.1.1 SWPPP Site Description**

Each plan shall provide a description of pollutant sources and all of the following information.

- (a) A description of the nature of the construction activity.
- (b) A description of the intended sequence and schedule of major activities that disturb soils for major portions of the site. At a minimum, the following applicable phases must be addressed: clearing and grubbing, excavation, earthwork and site grading (including embankment earthwork), site utilities, roads, and stabilization. The schedule must include estimated starting dates and duration. The description must include the limits of areas impacted by each phase.
- (c) Estimates of the total area of the site and the total area of the site that is expected to be disturbed by excavation, grading, or other construction activities.

- (d) Existing data describing the predominant soil types, the corresponding erodibility potential as described by the appropriate soil survey information or on-site investigations, the quality of any discharge from the site, and an estimate of the size of the drainage area for each discharge point.
- (e) A site map indicating existing and proposed topography, including drainage patterns and approximate slopes anticipated after major grading activities, areas of soil disturbance, an outline of areas that must not be disturbed, locations of surface waters of the state, and locations where stormwater is discharged to a surface water.
- (f) For each construction phase, a description of the individual structural, non-structural, and stabilization control measures are to be used (shown on construction plans or detail sheets), including:
  - 1. Estimated date of installation and removal;
  - 2. Location; and
  - 3. Purpose of measure and area served.
- (g) The latitude and longitude of each discharge point and the name of the receiving water(s) for each discharge point.
- (h) All supporting calculations and documentation, including referenced design standards and specifications.

#### **4.3.1.2 SWPPP Controls**

Each plan shall include a description of controls, Best Management Practices (BMPs), and measures that will be implemented at the construction site. The plan shall clearly describe for each major activity control measures and the timing during the construction process that the measures will be implemented. For example, perimeter controls for one portion of the site will be installed after the clearing and grubbing necessary for installation of the measure, but before the clearing and grubbing for the remaining portions of the site. Perimeter controls shall be actively maintained until final stabilization of those portions of the site upward of the perimeter control. Temporary perimeter controls shall be removed after final stabilization. All controls shall be designed to assure that the performance standards for erosion and sediment control and stormwater treatment as set forth in Rule 62-40.432, F.A.C, are met.

- (a) Erosion and Sediment Controls
  - 1. **Stabilization Practices.** Each plan shall provide a description of interim and permanent stabilization practices, including site-specific scheduling of the implementation of the practices. Site plans shall ensure that existing vegetation is preserved where attainable and that disturbed portions of the site are stabilized. Stabilization practices may include: temporary seeding, permanent seeding, mulching, geotextiles, sod stabilization, vegetative buffer strips, protection of trees, preservation of mature vegetation, and other appropriate measures. The plan shall include a record of the dates when major grading activities occur, when construction activities temporarily or permanently cease on a portion of the site and when stabilization measures are initiated. Stabilization measures shall be initiated as soon as practicable, but in no case more than 7 days, in portions of the site where construction activities have temporarily or permanently ceased.

2. **Structural Practices.** Each plan shall include a description of structural practices, to divert flows from exposed soils, store flows, retain sediment on-site, or otherwise limit runoff and the discharge of pollutants from exposed areas of the site. Such practices may include silt fences, earth dikes, diversions, swales, sediment traps, check dams, subsurface drains, pipe slope drains, level spreaders, storm drain inlet protection, rock outlet protection, reinforced soil retaining systems, gabions, coagulating agents and temporary or permanent sediment basins.

3. **Sediment Basins**

- a. For drainage basins with 10 or more disturbed acres at one time, a temporary (or permanent) sediment basin providing 3,600 cubic feet of storage per acre drained, or equivalent control measures, shall be provided where attainable until final stabilization of the site. The 3,600 cubic feet of storage area per acre drained does not apply to flows from offsite areas and flows from onsite areas that are either undisturbed or have undergone final stabilization where such flows are diverted around both the disturbed area and the sediment basin. For drainage basins with 10 or more disturbed acres at one time and where a temporary sediment basin providing 3,600 cubic feet of storage per acre drained, or equivalent controls is not attainable, a combination of smaller sediment basins and/or sediment traps and other BMPs shall be used. At a minimum, silt fences, or equivalent sediment controls are required for all sideslope and downslope boundaries of the construction area.
- b. For drainage basins of less than 10 acres, sediment basins and/or sediment traps are recommended but not required. At a minimum, silt fences or equivalent sediment controls are required for all side slope and down slope boundaries of the construction area.
- c. Areas that will be used for permanent stormwater infiltration treatment (e.g., stormwater retention ponds) shall not be used for temporary sediment basins unless effective measures are taken to assure timely removal of accumulated fine sediments, which may cause premature clogging and loss of infiltration capacity, and to avoid excessive compaction of soils by construction machinery or equipment.
- d. Sizing of sediment sumps or basins – Key components in sizing sediment sumps for a BMP or in sizing a sediment basin include the soil particle size(s) to be settled, the flow velocity, and the length to depth ratio. An example sediment sump design is shown in **Section 4.4** below.

(b) **Controls for Other Potential Pollutants**

1. **Waste Disposal.** The plan shall assure that waste, such as discarded building materials, chemicals, litter, and sanitary waste are properly controlled in accordance with all applicable state, local, and federal regulations. This permit does not authorize the discharge of solid materials, including building materials, to waters or a Municipal Separate Storm Sewer System (MS4).
2. The plan shall assure that off-site vehicle tracking of sediments and the generation of dust is minimized.

3. The plan shall be consistent with applicable State and local waste disposal, sanitary sewer or septic system regulations.
4. The plan shall specify application rates and methods consistent with the manufacturer's federally-approved label for the use of fertilizers, herbicides and pesticides at the construction site and set forth how these procedures will be implemented and enforced. Nutrients shall be applied only at rates necessary to establish and maintain vegetation.
5. The plan shall ensure that the application, generation, and migration of toxic substances will not cause water quality violations and that toxic materials are properly stored and disposed.

#### **4.3.1.3 Maintenance Requirements Associated with an SWPPP**

The plan shall include a description of procedures that will be followed to ensure the timely maintenance of vegetation, erosion and sediment controls, stormwater management practices, and other protective measures and BMPs so they will remain in good and effective operating condition.

#### **4.3.1.4 Inspections**

A qualified inspector (provided by the owner or operator) shall perform all necessary site inspections. A qualified inspector is defined as someone who has successfully completed the Department's Stormwater, Erosion, and Sedimentation Control Inspector Training Program. Completion of an equivalent training program shall also serve to qualify an inspector if the program is substantially equivalent to the Department's program. Site inspections must include all points of discharge into surface waters or an MS4; disturbed areas of the construction site that have not been finally stabilized; areas used for storage of materials that are exposed to precipitation; structural controls; and locations where vehicles enter or exit the site. Site inspections shall be conducted at least once every seven calendar days and within 24 hours of the end of a storm that is 0.50 inches or greater. Inspections shall include:

- (a) Disturbed areas and areas used for storage of materials that are exposed to precipitation shall be inspected for evidence of, or the potential for, pollutants entering the stormwater system. The stormwater management system and erosion and sediment control measures identified in the plan shall be observed to ensure that they are operating correctly. Discharge locations or points shall be inspected to ascertain whether erosion and sediment control and stormwater treatment measures are effective in preventing or minimizing the discharge of pollutants, including retaining sediment onsite pursuant to Rule 62-40.432, F.A.C. Locations where vehicles enter or exit the site shall be inspected for evidence of offsite sediment tracking.
- (b) Based on the results of the inspection, all maintenance operations needed to assure proper operation of all controls, BMPs, practices, or measures identified in the stormwater pollution prevention plan shall be done in a timely manner, but in no case later than 7 calendar days following the inspection. If needed, pollution prevention controls, BMPs, and measures identified in the plan shall be revised as necessary to assure proper operation of all controls, BMPs, practices, or measures identified in the stormwater pollution prevention plan. Such revisions shall provide for timely implementation of any changes to the plan within 7 calendar days following the inspection.

- (c) A report summarizing the scope of the inspection; name(s) and qualifications of personnel making the inspection; the date(s) of the inspection; rainfall data; major observations relating to the implementation of the stormwater pollution prevention plan; and actions taken in accordance with the requirements of this permit, shall be made and retained as part of the stormwater pollution prevention plan. Such reports shall identify any incidents of non-compliance. Where a report does not identify any incidents of non-compliance, the report shall contain a certification that the facility is in compliance with the stormwater pollution prevention plan and this permit.

#### 4.4 *Sediment Sump Design Example*

A horizontal-flow sump or sediment basin must remove the desired particle under peak flow conditions. The length of the sediment sump or basin will be governed by the depth required by the settling velocity of the particle, and the cross-sectional area will be governed by the rate of flow.

A length to depth ratio for the sediment sump or basin can be calculated:

$$\frac{\text{Flow through velocity (V)}}{\text{Settling velocity (V}_s\text{)}} = \frac{\text{length of sump (l)}}{\text{depth of sump (h)}}$$

The cross-sectional area (A) required for peak flow (Qp) at a flow through velocity (V):

$$Q_p = AV \quad A = Q_p/V$$

The cross-sectional area (A) is the width of the sump (W) multiplied by the depth of the sump (h):

$$A = Wh$$

The sump can be sized using the these equations:

Equation 4-1  $\frac{l}{h} = \frac{Vd}{V_s}$

Equation 4-2  $\frac{Q_p}{Wh} = Vd$

Where: Qp = design peak rate of flow  
 Vd = flow through velocity  
 Vs = settling velocity  
 l = length of sump  
 W = width of sump  
 h = depth of sump

Vs is the settling velocity for a discrete particle using Stoke's Law:

$$V_s = (g/18) ((S_s - 1)/\nu) d^2$$

Where: Vs = settling velocities  
 Ss = specific gravity of particle



- v = kinematic viscosity
- d = diameter of particle
- g = acceleration due to gravity

Remember that the Reynolds number for flow must be less than one for Stoke's Law to apply.

Given the following, calculate the settling velocity, the flow through velocity and the sump dimensions:

- d = 0.01 cm sand particle
- Ss = 2.65 for sand particle
- v =  $1.31 \times 10^{-2}$  cm<sup>2</sup>/sec with water at 20°C
- g = 981 cm/sec<sup>2</sup>

$$V_s = \frac{981}{18} \left( \frac{2.65-1}{1.31 \times 10^{-2}} \right) (0.01)^2 = 0.69 \text{ cm/sec}$$

$$V_s = (0.69 \text{ cm/sec}) (0.3937 \text{ inch/cm}) (1 \text{ ft}/12 \text{ inches}) = 0.23 \text{ ft/sec}$$

V is the flow through velocity which must be less than the velocity required to transport the design particle:

$$Vd = \left( \frac{8K'}{f} \right) g d (Ss - 1) = Vd = \left( \frac{8(0.06)}{0.03} \right) (32.2) \left( \frac{0.00394}{12} \right) (2.65 - 1) = 0.26 \text{ ft/sec}$$

- Where:
- Vd = velocity required to transport water born particle
  - d = diameter of the particle = 0.01 cm = 0.0394 inches
  - f = Weesbach-Darcy friction factor = 0.03
  - K' = Cohesiveness factor of particle = 0.06 (clean grit = 0.04, sticky = 0.8)
  - Ss = Specific gravity of particle = 2.65
  - g = acceleration due to gravity = 32.2 ft/sec<sup>2</sup>

To determine the sediment sump dimensions given the following:

$$\begin{aligned} Vd &= 0.26 \text{ ft/sec} & l &= (h Vd)/V_s \\ V_s &= 0.023 \text{ ft/sec} \\ Q_p &= 25 \text{ cfs} & w &= Q_p/(h Vd) \end{aligned}$$

By fixing one of the variables (w, h, l), the others can be calculated:

If h = 3.5 feet, then:

$$\begin{aligned} l &= (h Vd)/V_s = (3.5 * 0.26)/ 0.023 = 39.56 \text{ ft} \\ w &= Q_p/ (h Vd) = 25/ (3.5 * 0.26) = 27.47 \text{ ft} \end{aligned}$$

## PART V – BEST MANAGEMENT PRACTICES

Stormwater treatment systems are composed of best management practices (BMPs) that can be categorized into three basic types: retention BMPs, detention BMPs, and source control BMPs. Retention BMPs are also known as infiltration practices – the stormwater treatment volume is not discharged but is recovered through percolation into the soil, evaporation, and evapotranspiration. Infiltration BMPs include retention basins or trenches, exfiltration trenches, underground retention systems, underground retention vault/chamber, French drains, swales, vegetated natural buffers, pervious pavements, and greenroof/cistern systems. Detention BMPs are those that detain stormwater and discharge it at a specified rate, usually the predevelopment peak discharge rate. Detention practices include wet detention and underdrain filtration. Source control practices are nonstructural BMPs that are used to either minimize the amount of stormwater generated or minimize the amount of pollutants getting into the stormwater.

### 5.0 RETENTION BASIN DESIGN CRITERIA

#### 5.1 *Description*

A “retention system” is a recessed area within the landscape that is designed to store and retain a defined quantity of runoff, allowing it to percolate through permeable soils into the shallow ground water aquifer. This section discusses the requirements for retention systems, historically referred to as “dry retention basins”, which are constructed or natural depressional areas, often integrated into a site’s landscaping, where the bottom is typically flat, and turf, natural ground covers or other appropriate vegetation, or other methods are used to promote infiltration and stabilize the basin slopes (see **Figure 5.1**).

Soil permeability and water table conditions must be such that the retention basins can percolate the required treatment runoff volume within a specified time following a storm event. After drawdown has been completed, the basin does not hold any water, thus the system is normally “dry.” Unlike detention basins, the treatment volume for retention systems is not discharged to surface waters.

Retention basins provide numerous benefits, including reducing stormwater volume, which reduces the average annual pollutant loading that may be discharged from the system. Additionally, many stormwater pollutants such as suspended solids, oxygen demanding materials, heavy metals, bacteria, some varieties of pesticides, and nutrients are removed as runoff percolates through the soil profile.

To accomplish the desired level of pollutant load reduction, retention basins shall be designed in accordance with the following design and performance criteria.

#### 5.2 *Required Treatment Level and Associated Treatment Volume*

The Required Treatment Volume (RTV) necessary to achieve the required treatment efficiency shall be routed to the retention basin and percolated into the ground. The required nutrient load reduction will be determined by type of waterbody to which the stormwater system discharges and the associated performance standard as set forth in **Section 3.1** of this Handbook. Treatment volumes to achieve the necessary efficiencies shall be determined based on the percentage of directly connected impervious area (DCIA) and the weighted curve number for non-DCIA areas. **Appendix D** provides dry retention depths (inches of runoff over the drainage area) in order to achieve 85 percent removals for the various meteorological regions. For post=pre calculations, **Appendix F** provides performance efficiencies for dry retention runoff volumes for the various meteorological regions.

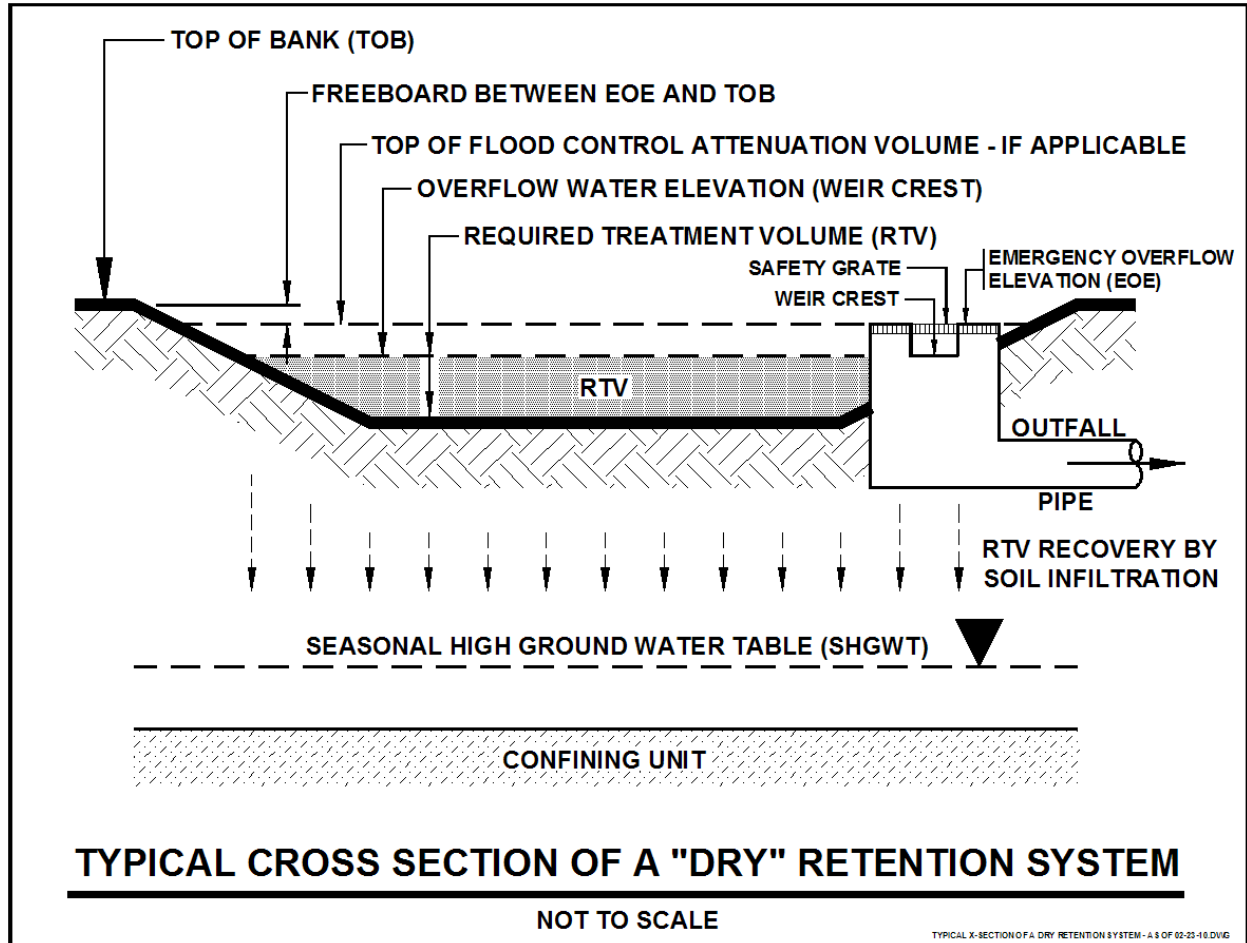

Figure 5.1 Typical Cross-section of “Dry” Retention Basin

### 5.3 Calculating Load Reduction Efficiency for a Given Retention Volume

If retention basins are being used as part of a BMP treatment train to achieve some level of pollutant load reduction but not the total amount of the required nutrient load reduction, the tables in **Appendix F** shall be used.

### 5.4 Design Criteria

- (a) The retention basin must have the capacity to retain the required treatment volume without a discharge and without considering soil storage.
- (b) The retention basin must recover the required treatment volume of stormwater within 72 hours, with a safety factor of two, assuming average Antecedent Runoff Condition (ARC 2). A recovery analysis is required that accounts for the mounding of ground water beneath the retention basin. Requirements related to safety factors, mounding analysis and supporting soil testing is provided in **Section 21.0** of this Handbook.

- (c) The seasonal high ground water table shall be at least two feet beneath the bottom of the retention basin unless the applicant demonstrates, based on plans, test results, calculations or other information, that an alternative design is appropriate for the specific site conditions.
- (d) The retention basin sides and bottom shall be stabilized with permanent vegetative cover, some other pervious material, or other methods acceptable to the Agency that will prevent erosion and sedimentation.
- (e) If retention basins are proposed within Sensitive Karst Areas, they shall be designed in accordance with the requirements in **Section 29** of this Handbook. Additional geotechnical information will be required.
- (f) Retention basins shall not be constructed within 50 feet of a public or private potable water supply well.

### **5.5 Required Site Information**

Successful design of a retention system depends greatly upon knowing conditions at the site, especially information about the soil, geology, and water table conditions. Specific data and analyses required for the design of a retention system including details related to safety factors, mounding analyses, and required soil testing are set forth in **Section 21** of this Handbook.

### **5.6 Retention Basin Construction**

Retention basin construction procedures and the overall sequence of site construction are two key factors that can control the effectiveness of retention basins. The applicant must demonstrate that the design infiltration rate will be met by minimizing soil compaction during construction and minimizing the amount of sediment deposited into the retention basin.

Because stormwater management systems are required to be constructed during the initial phases of site development, retention basins are often exposed to poor quality surface runoff. Stormwater runoff during construction contains considerable amounts of suspended solids, organics, clays, silts, trash and other undesirable materials. For example, the subgrade stabilization material used during construction of roadways and pavement areas typically consists of clayey sand or soil cement. If a storm occurs when these materials are exposed (prior to placement of the roadway wearing surface), considerable amounts of these materials end up in the stormwater conveyance system and the retention basin, hindering infiltration through the system. Another source of fine material generated during construction is disturbed surface soil that can release large quantities of organics and other fine particles. Fine particles of clay, silt, and organics at the bottom of a retention basin also create a poor infiltrating surface.

The following construction procedures are required to avoid degradation of retention basin infiltration capacity due to construction practices:

- (a) The location and dimensions of the retention basin shall be verified onsite prior to its construction. All design requirements including retention basin dimensions and distances to foundations, septic systems, wells, etc., need to be verified.
- (b) The location of retention basins shall be clearly marked at the site to prevent unnecessary vehicular traffic across the area causing soil compaction.

- (c) Initially construct the retention basin by excavating the basin bottom and sides to approximately 12 inches above final design grades.
- (d) Excavation shall be done by lightweight equipment to minimize soil compaction. Tracked, cleated equipment does less soil compaction than equipment with tires.
- (e) After the drainage area contributing to the basin has been fully stabilized, the interior side slopes and basin bottom shall be excavated to final design specifications. The excess soil and undesirable material must be carefully excavated and removed from the basin so that all accumulated silts, clays, organics, and other fine sediment material has been removed from the pond area. The excavated material shall be disposed of in a manner that assures it will not re-enter the retention basin.
- (f) Once the basin has been excavated to final grade, the entire basin bottom must be deep raked and loosened for optimal infiltration. The depth to be raked is dependent on the type, weight and contact pressure of the construction equipment used during the bulk excavation of the basin.

An applicant may propose alternative construction procedures to assure that the design infiltration rate of the constructed and stabilized retention basin is met.

### **5.7 *Inspections, Operation and Maintenance***

Maintenance issues associated with retention basins are related to clogging of the porous soils, which reduces or prevents infiltration thereby slowing recovery of the stormwater treatment volume and often resulting in standing water. Sedimentation can cause clogging and resulting sealing of the bottom or side slope soils. It can also occur from excessive loading of oils and greases or from excessive algal or microorganism growth. Standing water within a retention basin can also result from an elevated high water table or from ground water mounding, both of which can present long term operational issues that may require redesign of the system.

To determine if an infiltration system is properly functioning or whether it needs maintenance requires that an inspection be done within 72 hours after a storm. The inspection should determine if the retention basin is recovering its storage volume within its permitted time frames, generally 24 to 72 hours after a storm. If this is not occurring and there is standing water, then the cause must be determined and actions undertaken beginning with those specified in the system's Operation and Maintenance Plan.

- (a) Inspection Items:
  - (1) Inspect basin for storage volume recovery within the permitted time, generally less than 72 hours. Failure to percolate the required treatment volumes indicates reduction of the infiltration rate and a need to restore system permeability.
  - (2) Inspect and monitor sediment accumulation on the basin bottom or inflow to prevent clogging of the retention basin or the inflow pipes.
  - (3) Inspect vegetation of bottom and side slopes to assure it is healthy, maintaining coverage, and that no erosion is occurring within the retention basin.

- (4) Inspect inflow and outflow structures, trash racks, and other system components for accumulation of debris and trash that would cause clogging and adversely impact operation of the retention basin.
  - (5) Inspect the retention basin for potential mosquito breeding areas such as where standing water occurs after 72 hours or where cattails or other invasive vegetation becomes established.
- (b) Maintenance Activities As-Needed To Prolong Service:
- (1) If needed, restore the infiltration capacity of the retention basin so that it meets the permitted recovery time for the required treatment volume.
  - (2) Remove accumulated sediment from retention basin bottom and inflow and outflow pipes and dispose of properly. Please note that stormwater sediment disposal may be regulated under Chapter 62-701, F.A.C. (See **Appendix I**). Sediment removal should be done when the system is dry and when the sediments are cracking.
  - (3) Remove trash and debris inflow and outflow structures, trash racks, and other system components to prevent clogging or impeding flow.
  - (4) Maintain healthy vegetative cover to prevent erosion in the basin bottom, side slopes or around inflow and outflow structures. Vegetation roots also help to maintain soil permeability. Grass needs to be mowed and grass clippings removed from the basin to reduce internal nutrient loadings.
  - (5) Eliminate mosquito breeding habitats.
  - (6) Assure that the contributing drainage area is stabilized and not a source of sediments.

## 6.0 EXFILTRATION TRENCH DESIGN CRITERIA

### 6.1 *Description*

An exfiltration trench is a subsurface retention system consisting of a conduit such as perforated pipe surrounded by natural or artificial aggregate which temporarily stores and infiltrates stormwater runoff (**Figure 6.1**). Stormwater passes through the perforated pipe and infiltrates through the trench walls and bottom into the shallow ground water aquifer. The perforated pipe increases the storage available in the trench and helps promote infiltration by making delivery of the runoff more effective and evenly distributed over the length of the system.

Soil permeability and water table conditions must be such that the trench system can percolate the required stormwater runoff treatment volume within a specified time following a storm event. The trench system is returned to a normally “dry” condition when drawdown of the treatment volume is completed. Similar to retention basins, the treatment volume in exfiltration trench systems is not discharged to surface waters.

Like other types of retention systems, exfiltration trenches provide reduction of stormwater volume which reduces pollutant loads. Additionally, substantial amounts of suspended solids, oxygen demanding materials, heavy metals, bacteria, some varieties of pesticides and nutrients such as phosphorus may be removed as runoff percolates through the soil profile.

The operational life of an exfiltration trench depends on site conditions, system design, and maintenance. Sediment accumulation and clogging by fines can reduce the life of an exfiltration trench. Total replacement of the trench may be the only possible means of restoring the treatment capacity and recovery of the system. Periodic replacement of the trench should be considered routine operational maintenance when selecting this management practice. As such, exfiltration trenches must be located where replacement can readily occur. They shall not be placed within 10 feet of a building and must be designed with adequate accessibility for maintenance or trench replacement.

Because of the unique hydrogeological conditions found in Miami-Dade County, exfiltration trenches are not typically designed to be completely above the SHGWT as is the case in the rest of the state. These systems are termed “wet” exfiltration trenches as shown in **Figure 6.2**.

### 6.2 *Required Level of Treatment and Associated Treatment Volume*

The Required Treatment Volume (RTV) necessary to achieve the required treatment efficiency shall be routed to the exfiltration trench and percolated into the ground. The required nutrient load reduction will be determined by type of waterbody to which the stormwater system discharges and the associated performance standard as set forth in Section 3.1. of this Handbook. Treatment volumes to achieve the necessary efficiencies shall be determined based on the project’s percentage of directly connected impervious area (DCIA) and the weighted curve number for non-DCIA areas. **Appendix D** provides dry retention depths (inches of runoff over the drainage area) in order to achieve 85 percent removals for the various meteorological regions. For post=pre calculations, **Appendix F** provides performance efficiencies for dry retention runoff volumes for the various meteorological regions.

Exfiltration trenches must be designed to have the capacity to retain the required treatment volume without discharging to ground or surface waters.

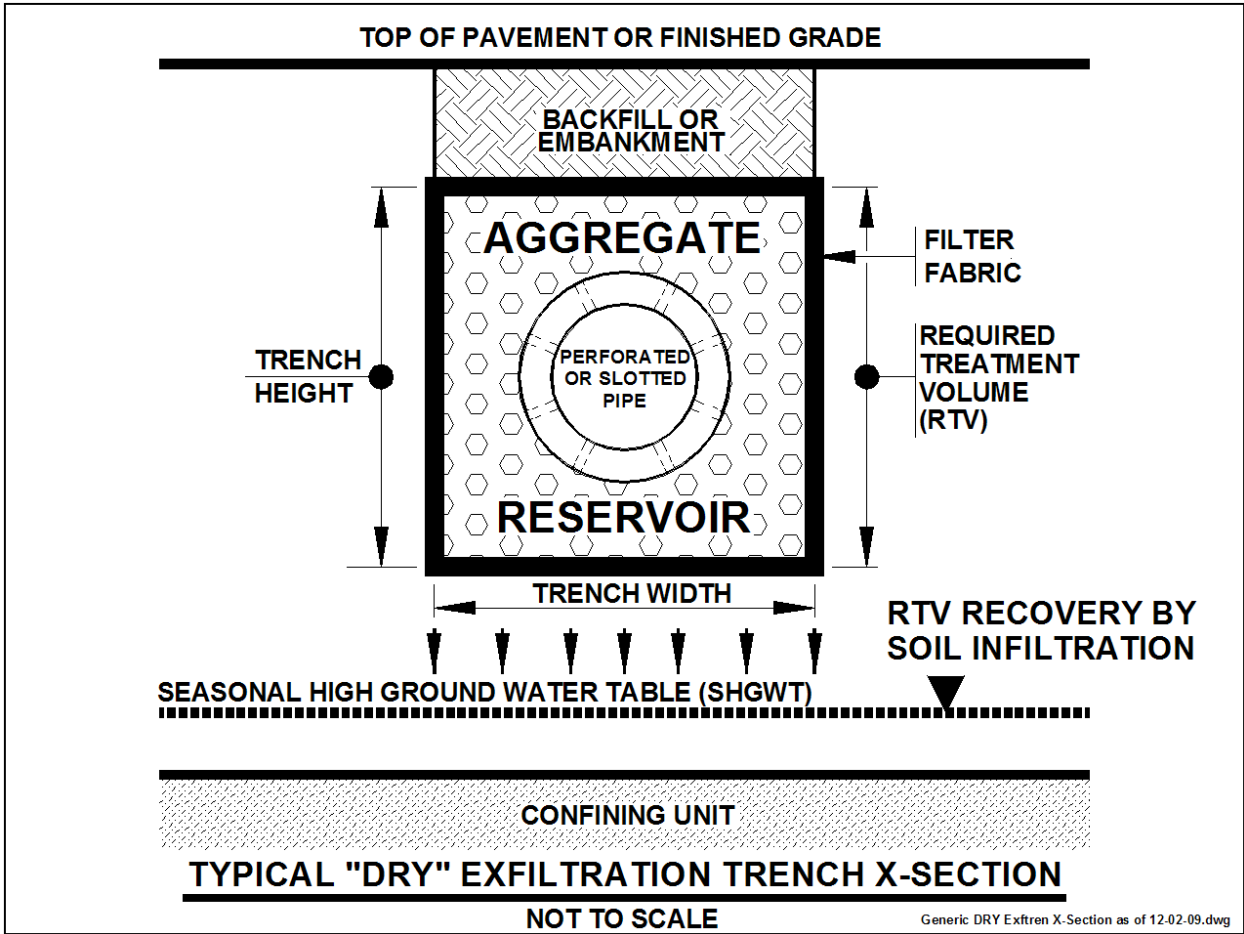

Figure 6.1 Cross-section of a “DRY” Exfiltration Trench (N.T.S.)

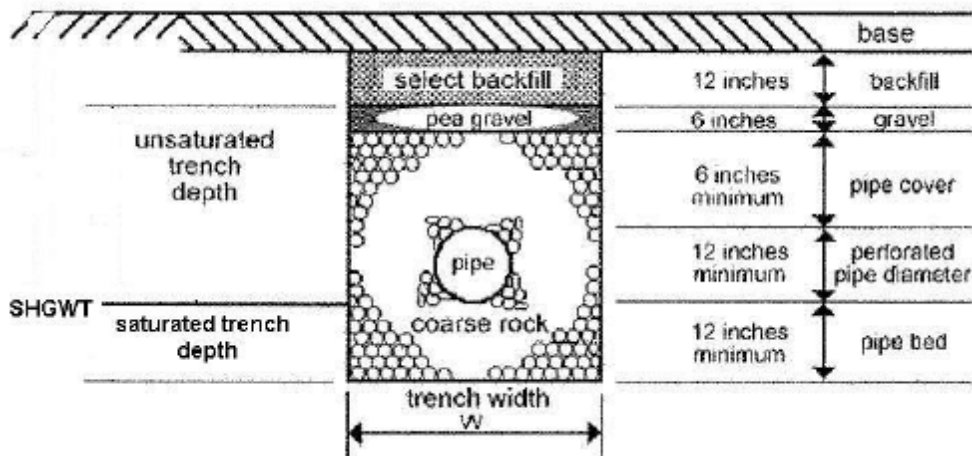

Figure 6.2 Generic “WET” exfiltration trench



### **6.3 *Calculating Load Reduction Efficiency for a Given Retention Volume***

If exfiltration trenches are being used as part of a BMP treatment train to achieve some level of pollutant load reduction but not the total amount of the required nutrient load reduction, the tables in **Appendix F** shall be used.

### **6.4 *Design and Performance Criteria***

- (a) Exfiltration trenches must have the capacity to retain the required treatment volume without a discharge and without considering soil storage.
- (b) The required treatment volume initially shall be retained in the perforated/slotted pipe and the surrounding aggregate reservoir.
- (c) Exfiltration trenches shall only be permitted for projects to be operated by entities with single owners or entities with full-time maintenance staffs.
- (d) The exfiltration trench must provide the capacity for the required treatment volume of stormwater within 72 hours, with a safety factor of two, following a storm event assuming average antecedent runoff condition (ARC 2). In exfiltration systems, the stormwater is drawn down by natural soil infiltration and dissipation into the ground water table as opposed to underdrain systems which rely on artificial methods such as drainage pipes. A recovery analysis is required that accounts for the mounding of ground water beneath the exfiltration system. Details related to safety factors, mounding analysis and supporting soil testing is provided in **Section 21** of this Handbook.
- (e) Minimum perforated or slotted pipe diameter shall be twelve (12) inches.
- (f) Minimum aggregate reservoir trench width shall be three (3) feet.
- (g) To assure recovery of the Required Treatment Volume (RTV), a dry exfiltration trench must be designed so that the invert elevation of the trench must be at least two feet above the seasonal high ground water table elevation unless the applicant demonstrates, based on plans, test results, calculations or other information, that an alternative design is appropriate for the specific site conditions. Refer to **Figure 6.1** for additional information.
- (h) Because of the unique aquifer characteristics, wet exfiltration trenches will only be allowed within Miami-Dade County. Refer to **Figure 6.2** for additional information.
- (i) To prevent surrounding soil migration into the aggregate reservoir, the reservoir must be enclosed on all sides by a permeable woven or non-woven filter fabric. The permeability of the filter fabric must be greater than the permeability of the surrounding soil.
- (j) To facilitate inspection of proper operation and maintenance of the exfiltration system, the system must be designed with sufficient access for inspection. Appropriate inspection access is dependent on the design of the specific system, but all must provide the ability to determine whether the system is maintaining the design infiltration rate and storage volume. Examples of acceptable inspection methods include designing the system such that the terminal ends of any perforated/slotted pipe or storage areas either:
  - Terminating in an accessible drainage inlet or manhole; or

- Having an eight (8) inch minimum diameter inspection port installed at any terminal “dead end” of any perforated/slotted pipe or storage areas.
  - Having an observation well that allows checking of the recovery of the RTV
- Refer to **Figure 6.3** for additional information and recommendations.
- (k) To provide a collection space for trash and other inflow debris, a minimum 24-inch deep maintenance sump will be required for all system inlets and manholes. A minimum twelve-inch (12”) diameter weep hole shall be placed in the bottom of the maintenance sump to facilitate the infiltration of stormwater into the underlying soils after a rainfall event. Refer to **Figure 6.3** for additional information and recommendations.
- (l) To reduce the potential for trash, debris and oil/grease inflow into the exfiltration trench system; a baffle, trash tee or other equivalent device must be installed at the end of the perforated/slotted pipe(s) in all access inlets and manholes. Refer to **Figures 6.4** and **6.5** for additional information and recommendations.
- (m) Sustainable void spaces must be used in computing the storage volume in the aggregate reservoir. These aggregate void space values shall be the greater of the following:
- 35% of aggregate volume; or
  - 80% of the measured testing lab values for the selected aggregate(s), if obtained and certified by a Florida licensed geotechnical professional.
- (n) The material used in the aggregate reservoir shall be washed to assure that no more than five percent (5%) of the materials passing a #200 sieve.
- (o) Exfiltration trenches shall not be constructed within 50 feet of a public or private potable water supply well.
- (p) If exfiltration trenches are proposed within Sensitive Karst Areas, they shall be designed in accordance with the requirements in **Section 29** of this Handbook. Additional geotechnical information will be required.

## **6.5 Required Site Information**

Design of an exfiltration system must consider site conditions including soil, geology, and water table conditions. Specific data and analyses required for the design of an exfiltration trench are set forth in **Section 21.0** of this Handbook.

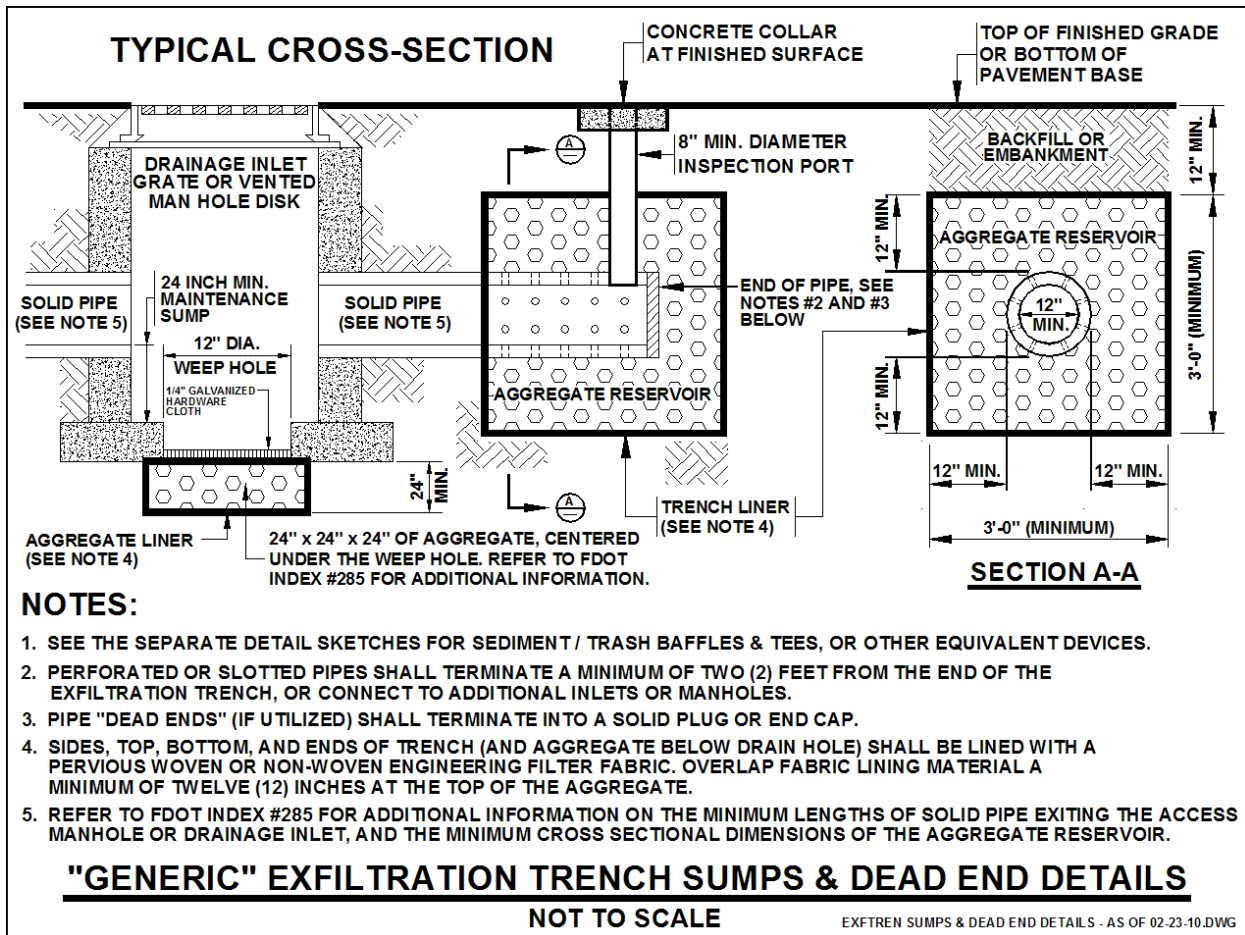

Figure 6.3 Typical Exfiltration Trench Sumps and Dead End Details

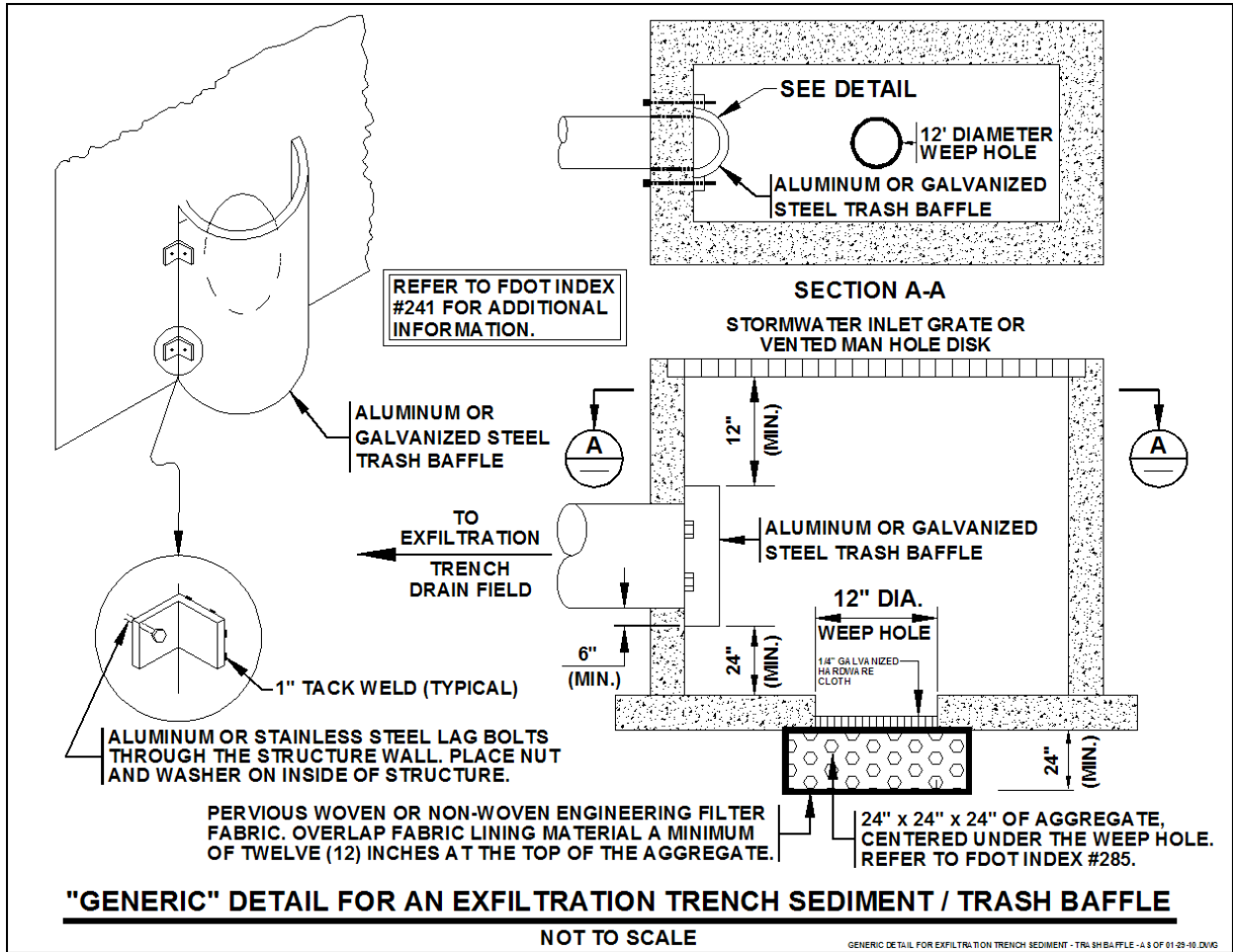

Figure 6.4 Detail for Exfiltration Trench Trash Baffle

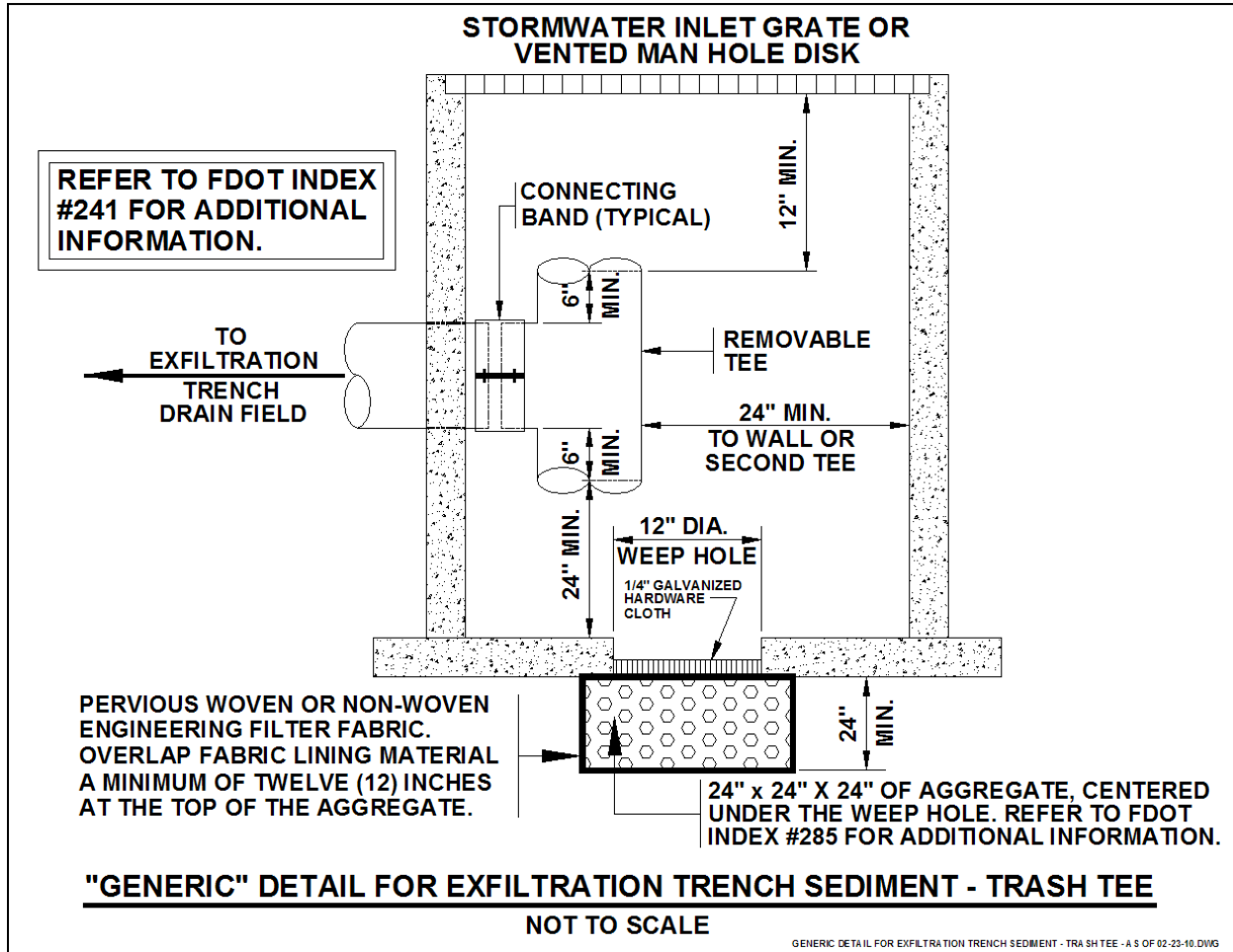

Figure 6.5 Generic Detail for a Typical Exfiltration Trench Trash Tee

6.6 Construction requirements

During construction, every effort should be made to limit the parent soil and debris from entering the trench. Any method used to reduce the amount of fines entering the exfiltration trench during construction will extend the life of the system.

- (a) The location and dimensions of the exfiltration trench shall be verified onsite prior to trench construction. All design requirements including trench dimensions and distances to foundations, septic systems, wells, etc., need to be verified.
- (b) To minimize sealing of the soil surface, the trench shall be excavated with a backhoe rather than front-end loaders or bulldozers whose blades will seal the infiltration soil surface.
- (c) Excavated materials shall be placed a sufficient distance from the sides of the excavated area to minimize the risk of sidewall cave-ins and prevent the material from re-entering the trench.
- (d) The trench bottom and side walls shall be inspected for materials that could puncture or tear the filter fabric, such as tree roots, and assure they are not present.

- (e) The aggregate material shall be inspected prior to placement to ensure it meets size specifications and is washed to minimize fines and debris.
- (f) Inflows to the trench shall be temporarily blocked until the contributing drainage area is stabilized to prevent sediment from entering and clogging the trench.
- (g) An applicant may propose alternative construction procedures to assure that the permitted infiltration rate of the constructed exfiltration trench is met provided they are acceptable and approved by the Agency.

## **6.7 Inspections, Operation and Maintenance**

### (a) Inspection Items:

- (1) Monitor facility for sediment accumulation in the pipe (when used) and storage volume recovery (i.e., drawdown capacity). Observation wells and inspection ports should be checked following 3 days minimum dry weather. Failure to percolate stored runoff to the design treatment volume level within 72 hours indicates binding of soil in the trench walls and/or clogging of geotextile wrap with fine solids. Reductions in storage volume due to sediment in the distribution pipe, also reduces efficiency. Minor maintenance measures can restore infiltration rates to acceptable levels short term. Major maintenance (total rehabilitation) is required to remove accumulated sediment in most cases or to restore recovery rate when minor measures are no longer effective or cannot be performed due to design configuration.
- (2) Inspect appurtenances such as sedimentation and oil and grit separation traps or catch basins as well as diversion devices and overflow weirs when used. Diversion facilities and overflow weirs should be free of debris and ready for service. Sedimentation and oil/grit separators should be scheduled for cleaning when sediment depth approaches cleanout level. Cleanout levels should be established not less than 1 foot below the invert elevation of the chamber.

### (b) As-Needed To Prolong Service:

- (1) Remove sediment from sediment or oil/grease traps, catch basin inlets, manholes, and other appurtenant structures and dispose of properly.
- (2) Remove debris from the outfall or “Smart Box” (diversion device in the case of off-line facilities).
- (3) Removal of sediment and cleaning of trench system. This process normally involves facilities with large pipes. Cleanout may be performed by suction hose and tank truck and/or by high-pressure jet washing.

### (c) As-Needed To Maintain 72-Hour Exfiltration Rate:

- (1) Periodic clean-out or rehabilitation of the system to remove any accumulated trash, sediment and other inflow debris and remediate any clogging of perforated pipes.
- (2) Total replacement of the system. In some cases the system may not be able to be rehabilitated sufficiently to restore the design storage and infiltration rate. In these

cases, complete replacement of the system may be necessary. The applicant shall provide an estimate of the expected life expectancy of the exfiltration trench and an estimate of the cost to replace the trench.

## 7.0 UNDERGROUND STORAGE AND RETENTION SYSTEMS DESIGN CRITERIA

### 7.1 *Description*

Underground storage and retention systems are special types of retention systems that capture the Required Treatment Volume (RTV) in an underground storage system and “drainfield”. Generally, these systems consist of lightweight, high strength modular units with “open” bottoms to allow for soil infiltration (refer to **Figure 7.1**). These systems are sometimes used where land values are high, and the owner/applicant desires to minimize the potential loss of usable land with other types of retention Best Management Practices (BMPs). Unlike underground vault systems described in **Chapter 8**, underground retention systems are not intended to have human access for maintenance.

### 7.2 *Required Treatment Volume*

The Required Treatment Volume (RTV) necessary to achieve the required treatment efficiency shall be routed to the underground storage and retention system and percolated into the ground. The required nutrient load reduction will be determined by type of waterbody to which the stormwater system discharges and the associated performance standard as set forth in **Section 3.1** of this Handbook. Treatment volumes to achieve the necessary efficiencies shall be determined based on the project’s percentage of directly connected impervious area (DCIA) and the weighted curve number for non-DCIA areas. **Appendix D** provides dry retention depths (inches of runoff over the drainage area) in order to achieve 85 percent removals for the various meteorological regions. For post=pre calculations, **Appendix F** provides performance efficiencies for dry retention runoff volumes for the various meteorological regions.

Underground storage and retention systems must be designed to have the capacity to retain the required treatment volume without considering discharges to ground or surface waters.

### 7.3 *Calculating Load Reduction Efficiency for a Given Retention Volume*

If underground storage and retention systems are being used as part of a BMP treatment train to achieve some level of pollutant load reduction but not the total amount of the required nutrient load reduction, the tables in **Appendix F** shall be used.

### 7.4 *Design Criteria*

- (a) The underground storage and retention system must have the capacity to retain the required treatment volume without a discharge and without considering soil storage.
- (b) The underground storage and retention system must recover the required treatment volume of stormwater within 72 hours, with a safety factor of two, assuming average Antecedent Runoff Condition (ARC 2). A recovery analysis is required that accounts for the mounding of ground water beneath the retention basin. Details related to safety factors, mounding analysis and supporting soil testing is provided in **Section 21.0** of this Handbook.
- (c) The seasonal high ground water table shall be at least two feet beneath the bottom of the underground storage and retention system.



- (d) If underground storage and retention systems are proposed within Sensitive Karst Areas, they shall be designed in accordance with the requirements in **Section 29** of this Handbook. Additional geotechnical information will be required.
- (e) Sustainable void spaces must be used in computing the storage volume in the aggregate reservoir. These aggregate void space values shall be the greater of the following:
  - 35% of aggregate volume; or
  - 80% of the measured testing lab values for the selected aggregate(s), if obtained and certified by a Florida licensed geotechnical professional.
- (f) Minimum perforated or slotted pipe diameter of twelve (12) inches.
- (f) Minimum aggregate reservoir trench width of three (3) feet.
- (g) To minimize the loss of the Required Treatment Volume (RTV), the underground retention system must be designed so that the invert elevation of the trench must be at least two feet above the seasonal high ground water table elevation unless the applicant demonstrates, based on plans, test results, calculations or other information, that an alternative design is appropriate for the specific site conditions.
- (h) To facilitate inspection/maintenance of the underground retention system, the terminal ends of the perforated/slotted pipe must either:
  - Terminate in an accessible drainage inlet or manhole;
  - Have an eight (8") inch minimum diameter inspection port installed at any terminal "dead end" of the perforated/slotted pipe; or
  - Have an observation well that allows checking of the recovery of the RTV.
 Refer to **Figure 8.3** for additional information and recommendations. Alternatively, the applicant may propose a system that is manufactured with an equivalent functional component that would provide for inspection and maintenance.
- (j) To provide a collection space for trash and other inflow debris, a minimum 24-inch deep maintenance sump will be required for all system inlets and manholes. A minimum twelve inch (12") diameter weep hole shall be placed in the bottom of the maintenance sump to facilitate the infiltration of stormwater into the underlying soils after a rainfall event. Refer to **Figure 8.3** for additional information and recommendations. Alternatively, the applicant may propose a system that is manufactured with an equivalent functional component that would capture trash and other inflow debris and keep it out of the retention system.
- (k) To reduce the potential for trash, debris and oil/grease inflow into the underground retention system; a baffle, trash tee or other equivalent device must be installed at the end of the perforated/slotted pipe(s) in all access inlets and manholes. Refer to **Figures 8.4** and **8.5** for additional information and recommendations. Alternatively, the applicant may propose a system that is manufactured with an equivalent functional component that would capture trash, debris, and oil/grease inflow into the underground retention system
- (l) The Required Treatment Volume (RTV) shall be initially retained in the perforated/slotted pipe and the surrounding aggregate reservoir.

- (m) Underground storage and retention systems shall not be constructed within 50 feet of a public or private potable water supply well.

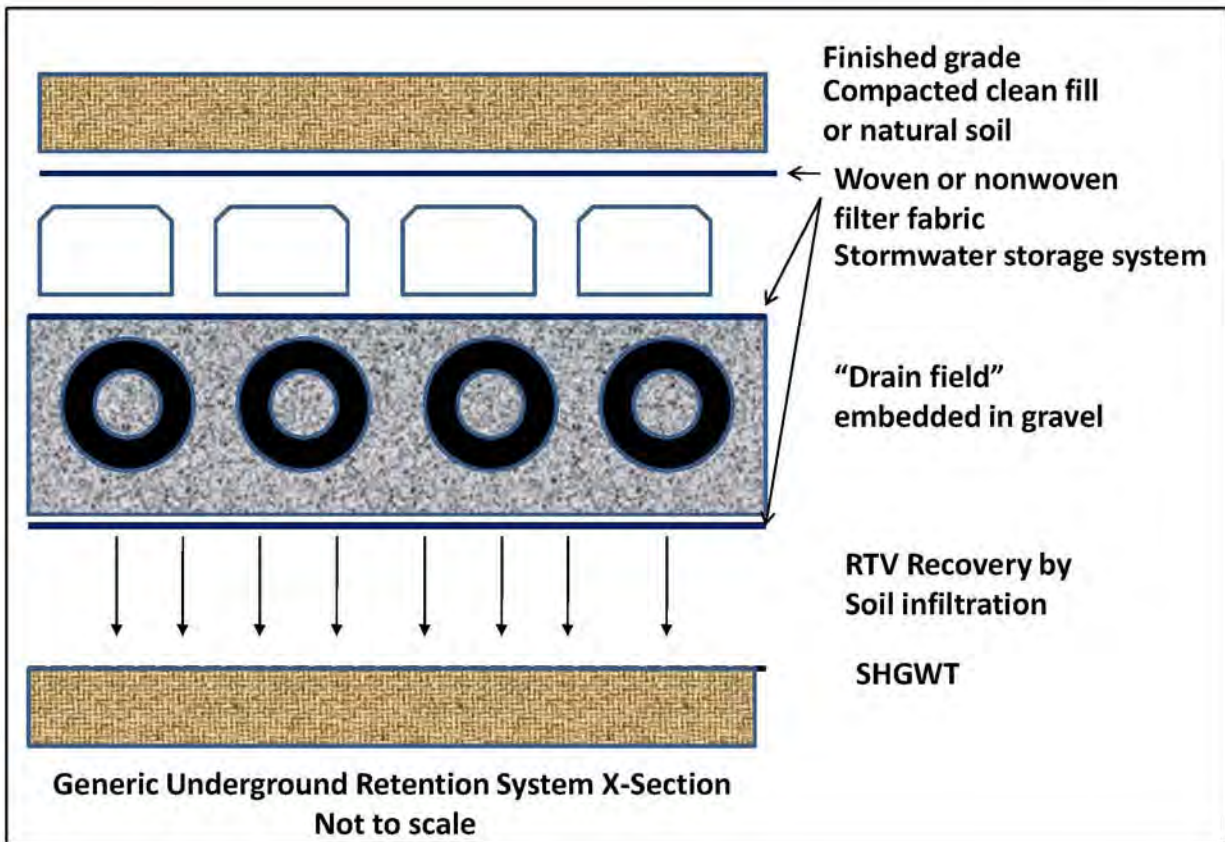

Figure 7.1 Generic Underground Retention System

### 7.5 Required Site Information

Design of an underground storage and retention system must carefully consider site conditions including soil, geology, and water table conditions. Specific data and analyses required for the design of an underground storage and retention system are set forth in **Section 21.0**.

### 7.6 Construction requirements

The following construction procedures are required to avoid degradation of underground retention system infiltration capacity due to construction practices:

- (a) The location of underground retention system shall be clearly marked at the site to prevent unnecessary vehicular traffic across the area causing soil compaction.
- (b) During construction, erosion and sediment controls shall be used to minimize the amount of soil, especially the amount of fines, and debris entering the system.
- (c) During construction, inlet pipes shall be **temporarily** plugged, to prevent soil and debris from entering the system.

- (d) The underground retention system should not be placed into operation until the contributing drainage area is stabilized and the pretreatment sumps are constructed.

## 7.8 *Inspections, Operation and Maintenance*

### (a) General

Regular, routine inspection and maintenance is an important component of this type of underground system to ensure that it functions in a satisfactory manner. The maintenance intervals for an underground retention system are typically more frequent than standard “dry” retention ponds. The performance of the underground system will be related to the effectiveness of the up-gradient sediment/trash removal devices (refer to **Figures 8.2 and 8.3**), and the frequency of inspections and maintenance activities for all of the underground retention system’s components.

The guidelines outlined below are intended to provide a comprehensive schedule that gives reasonable assurance that regulatory agency requirements and recommendations are being met.

### (b) Indication of system failure:

Standing water over sub-grade soils at the bottom of the underground retention system 72 hours after a storm event typically indicates system failure. Long term system failures are generally the result of inadequate/improper O&M procedures within the up-gradient sediment / trash removal devices, and/or within the underground retention system itself.

### (c) Sub-grade Soil Maintenance

The sub-grade soils at the bottom of this system are the only mechanism to provide water quality treatment (soil infiltration of the RTV). Therefore, the designed hydraulic conductivity rates within this soil must be maintained. Inspection ports and access manholes/trench grates are provided to facilitate ongoing inspection and maintenance activities. Failure to repair inflow/outflow scour erosion damage, or to remove detrimental materials (i.e., trash, clays, limerock debris, organic matter, etc.), will result in lower soil hydraulic conductivity rates, and subsequent system failure. Manual methods can be used for this required maintenance. However, the use of a vacuum truck for contaminate removal may be a more practical means of providing for the removal of these detrimental materials and sediments. Disposal of these contaminants shall be in an approved landfill facility.

### (d) Recommended inspection frequency

- (1) **After a large storm event of greater than one (1) inch of rainfall:** To ensure the (continued) free flow of stormwater, inspect the system and remove accumulated trash and debris from the up-gradient sediment/trash removal devices, and the inflow and outflow points of the down-gradient underground retention system.
- (2) **Every 6 months:** Perform a comprehensive inspection of the underground retention system for accumulated trash, debris and organic matter, and remove/dispose of these contaminants to ensure unimpeded stormwater flow. As appropriate, clean the surface of the sub-grade sands by raking, and check for accumulations in the various underground areas. If the sediment/contaminate accumulation is greater than two (2)

inches, a vacuum truck and/or similar equipment may be necessary for removal operations. Removed contaminants shall be taken to an approved offsite landfill.

- (3) **Annually, during September-November:** Monitoring of the drawdown time for the stormwater through the sub-grade sands shall be done to ensure recovery within 72 hours after the last rainfall event. Monitoring and observation of the drawdown times can be done visually through the inspection ports or observation well after a storm event. The drawdown of the water quality treatment volume (RTV) must recover within 72 hours after the storm event. If appropriate, post-construction hydraulic conductivity testing of the non-compacted soil floor [and their subsequent (certified) reports] shall be performed by the appropriate Florida licensed professional. Any post-construction soil testing reports shall be submitted to the Agency upon request.
  - (4) Drawdown times that exceed 72 hours are indicative of sub-grade clogging, and will likely require the removal of contaminants and raking of the sub-grade soils. The actual depth of removal can be done visually by looking at the discoloration of the entrapped fine silts, hydrocarbons (greases, oils), and organic matter. If required, replacement sub-grade soils must meet the design specifications under the original permit authorization.
  - (5) In addition to the sub-grade soils, other elements of the stormwater management system such as pipes, inlets, geotextile fabric, gravel, sediment/trash removal devices, etc., are to be inspected and repaired/replaced if needed.
- (e) Recommended Maintenance Activities
- (1) Monitor facility for sediment accumulation in the pipe (when used) and storage volume recovery (i.e., drawdown capacity). Observation wells and inspection ports should be checked following 3 days minimum dry weather. Failure to percolate stored runoff to the design treatment volume level within 72 hours indicates binding of soil within the system with fine solids. Reductions in storage volume due to sediment in the distribution pipe, also reduces efficiency. Minor maintenance measures can restore infiltration rates to acceptable levels short term. Major maintenance (total rehabilitation) is required to remove accumulated sediment in most cases or to restore recovery rate when minor measures are no longer effective or cannot be performed because of design configuration.
  - (2) Inspect appurtenances such as sedimentation and oil and grit separation traps or catch basins as well as diversion devices and overflow weirs when used. Diversion facilities and overflow weirs should be free of debris and ready for service. Sedimentation and oil/grit separators should be scheduled for cleaning when sediment depth approaches cleanout level. Cleanout levels should be established not less than 1 foot below control elevation of the chamber.
- (f) As-Needed To Prolong Service:
- (1) Remove sediment from sediment or oil/grease traps, catch basin inlets, manholes, and other appurtenant structures and dispose of properly.
  - (2) Remove debris from the outfall or “Smart Box” (diversion device in the case of off-line facilities).

- (g) As-Needed To Maintain 72-Hour Infiltration Rate:
- (1) Periodic clean-out/rehabilitation of the system to remove any accumulated trash, sediment and other inflow debris and remediate any clogging of perforated pipes, aggregates and geotextile fabrics.
  - (2) Total replacement of the system. In some cases the system, may not be able to be rehabilitated sufficiently to restore the design storage and infiltration rate. In these cases, complete replacement of the system may be necessary. During replacement, any removed sediment, contaminated soil, coarse aggregate, and filter cloth shall be disposed of properly.

## 8.0 UNDERGROUND RETENTION VAULT / CHAMBER SYSTEMS DESIGN CRITERIA

### 8.1 Description

Underground vaults or chambers are special types of retention systems that capture the Required Treatment Volume (RTV) in a “closed” environment, typically within a hardened structure. Generally, these systems have “open” bottoms in order to allow for soil infiltration (refer to **Figure 8.1** below).

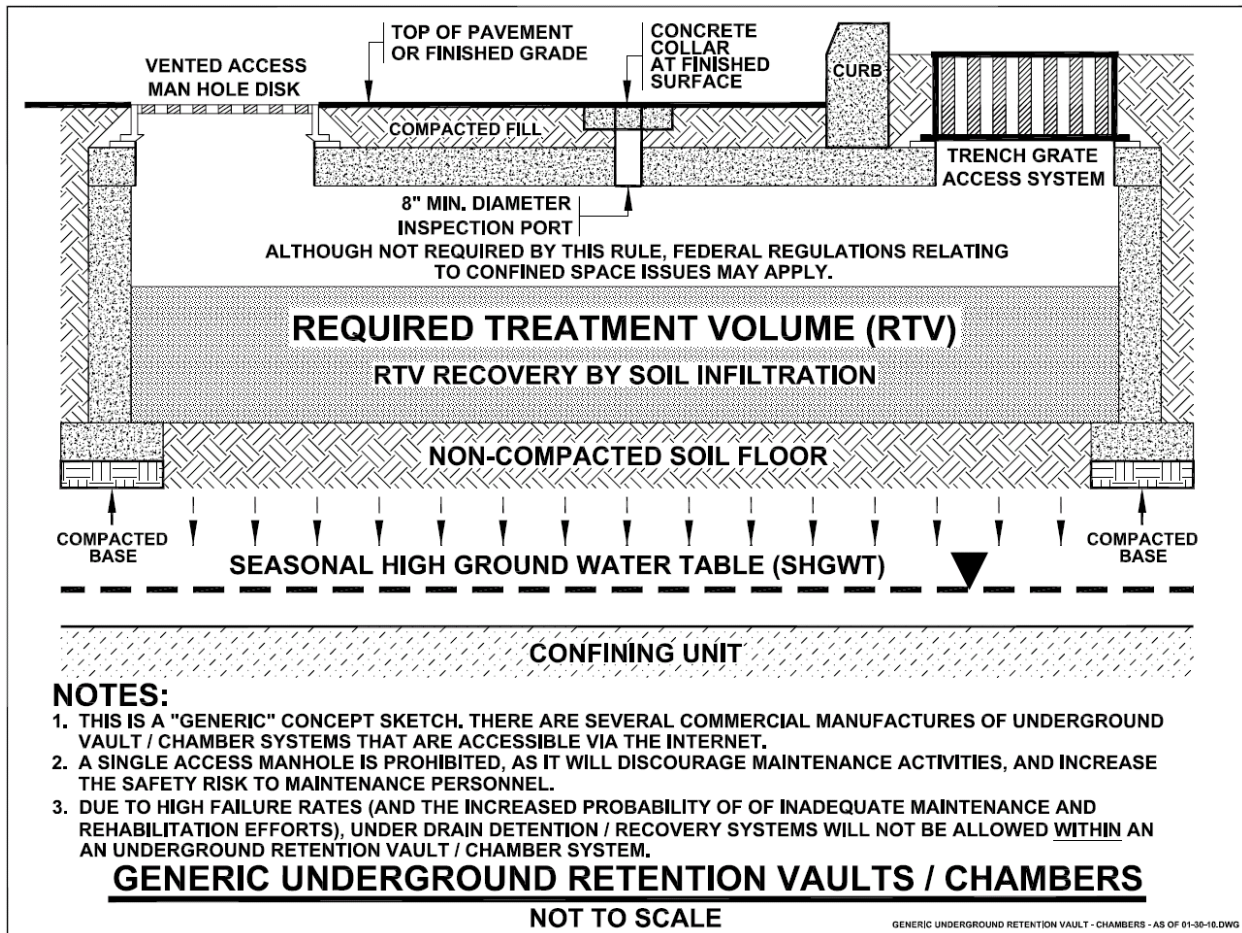

Figure 8.1 Generic Underground Retention Vault or Chamber

### 8.2 Required Treatment Volume

The Required Treatment Volume (RTV) necessary to achieve the required treatment efficiency shall be routed to the underground retention vault/chamber system and percolated into the ground. The required nutrient load reduction will be determined by type of water body to which the stormwater system discharges and the associated performance standard as set forth in **Section 3.1** of this Handbook. The RTV needed to achieve the necessary efficiencies shall be determined based on a project's percentage of directly connected impervious area (DCIA) and the weighted curve number for non-DCIA areas. **Appendix D** provides dry retention depths (inches of runoff over the drainage area) in order to achieve 85 percent removals for the various meteorological

regions. For post=pre calculations, **Appendix F** provides performance efficiencies for dry retention runoff volumes for the various meteorological regions.

Underground vault/chamber systems must be designed to have the capacity to retain the required treatment volume without considering discharges to ground or surface waters.

### **8.3 *Calculating Load Reduction Efficiency for a Given Retention Volume***

If underground vault/chamber systems are being used as part of a BMP treatment train to achieve some level of pollutant load reduction but not the total amount of the required nutrient load reduction, the tables in **Appendix F** shall be used.

### **8.4 *Design Criteria***

- (a) Underground vault/chamber systems must have the capacity to retain the required treatment volume without a discharge without considering soil storage.
- (b) Underground vault/chamber systems shall only be permitted for projects to be operated by entities with single owners or entities with full time maintenance staffs.
- (c) Underground vault/chamber systems cannot be used under buildings or other areas where there is not reasonable assurance of maintenance access for repair and replacement.
- (d) The underground vault/chamber system must recover the Required Treatment Volume (RTV) of stormwater to the bottom of the vault / chamber system (the top of the sub-grade soil) within 72 hours, with a safety factor of two, following a storm event, assuming average Antecedent Runoff Condition (ARC 2). In underground vault / chamber systems, the stormwater is drawn down by natural soil infiltration and dissipation into the ground water table, as opposed to underdrain systems which rely on artificial methods like perforated or slotted drainage pipes. A drawdown or recovery analysis is required that accounts for the mounding of ground water beneath the underground vault / chamber system. Details related to safety factors, recovery/mounding analysis and supporting soil testing is provided in **Section 21** of this Handbook.
- (f) The seasonal high ground water table shall be at least two feet beneath the bottom of the underground vault/chamber system unless the applicant demonstrates, based on plans, test results, calculations or other information, that an alternative design is appropriate for the specific site conditions.
- (g) The underground vault/chamber system shall include inspection ports or an observation well to assess system function after storm events or prior to maintenance activities. Refer to **Figure 8.1** for additional information.
- (h) The underground vault/chamber system shall include up-gradient sediment / trash removal devices prior to subsequent discharge into the underground vault / chamber system. Refer to **Figures 8.2 and 8.3** for additional information.
- (i) Underground vault/chamber systems shall have sufficient access to allow maintenance of the underlying soil's ability to infiltrate the required treatment volume.

- (j) Underground vault/chamber systems shall have more than one access point for maintenance activities. It is recommended that one of the access points be a “trench grate” access system.
- (l) Underground vault/chamber systems shall not have effluent underdrain detention / recovery systems within or directly beneath the vault / chamber due to the high degree of difficulty in long term maintenance and rehabilitation of the underdrains.
- (m) Effluent underdrain detention/recovery systems, outside and adjacent to the vault / chamber shall not be allowed unless the applicant affirmatively demonstrates based on plans, test results, calculations, and assurances of adequate access and long term Operation and Maintenance (O&M) procedures. If used, these external effluent underdrain detention/recovery systems must meet the criteria specified in **Section 17.0** of this Handbook, including the nutrient load reduction requirements.
- (n) Underground vault/chamber systems shall not be constructed within 50 feet of a public or private potable water supply well.
- (o) If underground vault/chamber systems are proposed within Sensitive Karst Areas, they shall be designed in accordance with the requirements in **Section 29** of this Handbook.

#### **8.5 Required Site Information**

Design of an underground vault/chamber systems must consider site conditions including soil, geology, and water table conditions. Specific data and analyses required for the design of an underground vault/chamber systems are set forth in **Section 21** of this Handbook.

#### **8.5 Construction requirements**

Underground vault/chamber system construction procedures and the overall sequence of site construction are two key factors that can control their effectiveness and longevity. Concerns that must be addressed to ensure that the design infiltration rate is met include minimizing soil compaction during construction and minimizing the amount of sediment that enters the system.

The following construction procedures are required to avoid degradation of underground vault/chamber system infiltration capacity due to construction practices:

- (a) The location and dimensions of the underground vault/chamber system shall be verified onsite prior to its construction. All design requirements such as distance to foundations, septic systems, and wells need to be verified.
- (b) Excavation for the underground vault/chamber system shall be done in such a way as to minimize soil compaction of the bottom of the system.
- (c) Excavated materials shall be placed a sufficient distance from the sides of the excavated area to minimize the risk of sidewall cave-ins and prevent the material from re-entering the system.
- (d) Inflows to the system shall be temporarily blocked until the contributing drainage area is stabilized to prevent sediment from entering and clogging the system.



- (e) An applicant may propose alternative construction procedures to assure that the design infiltration rate of the constructed underground vault/chamber system is met.

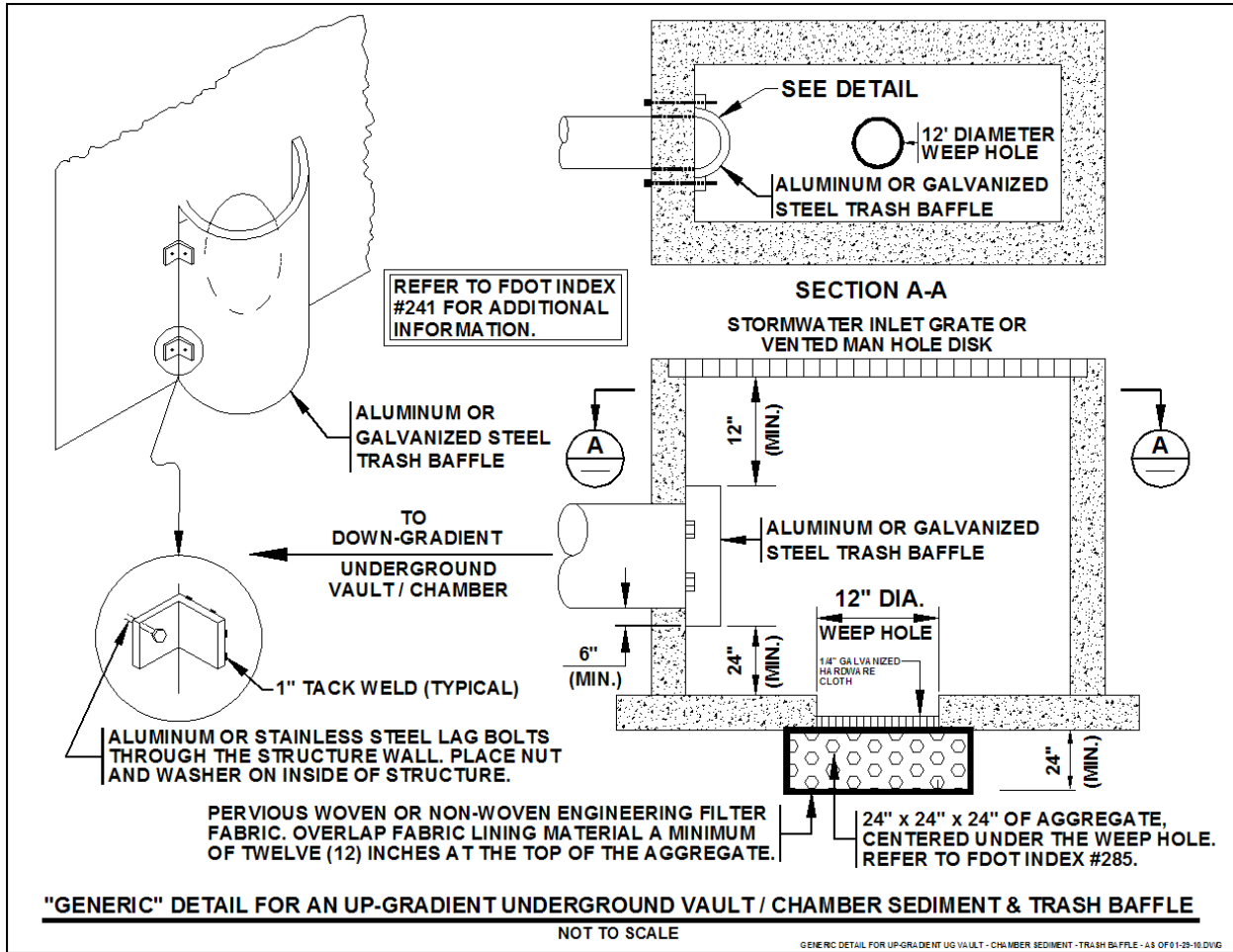
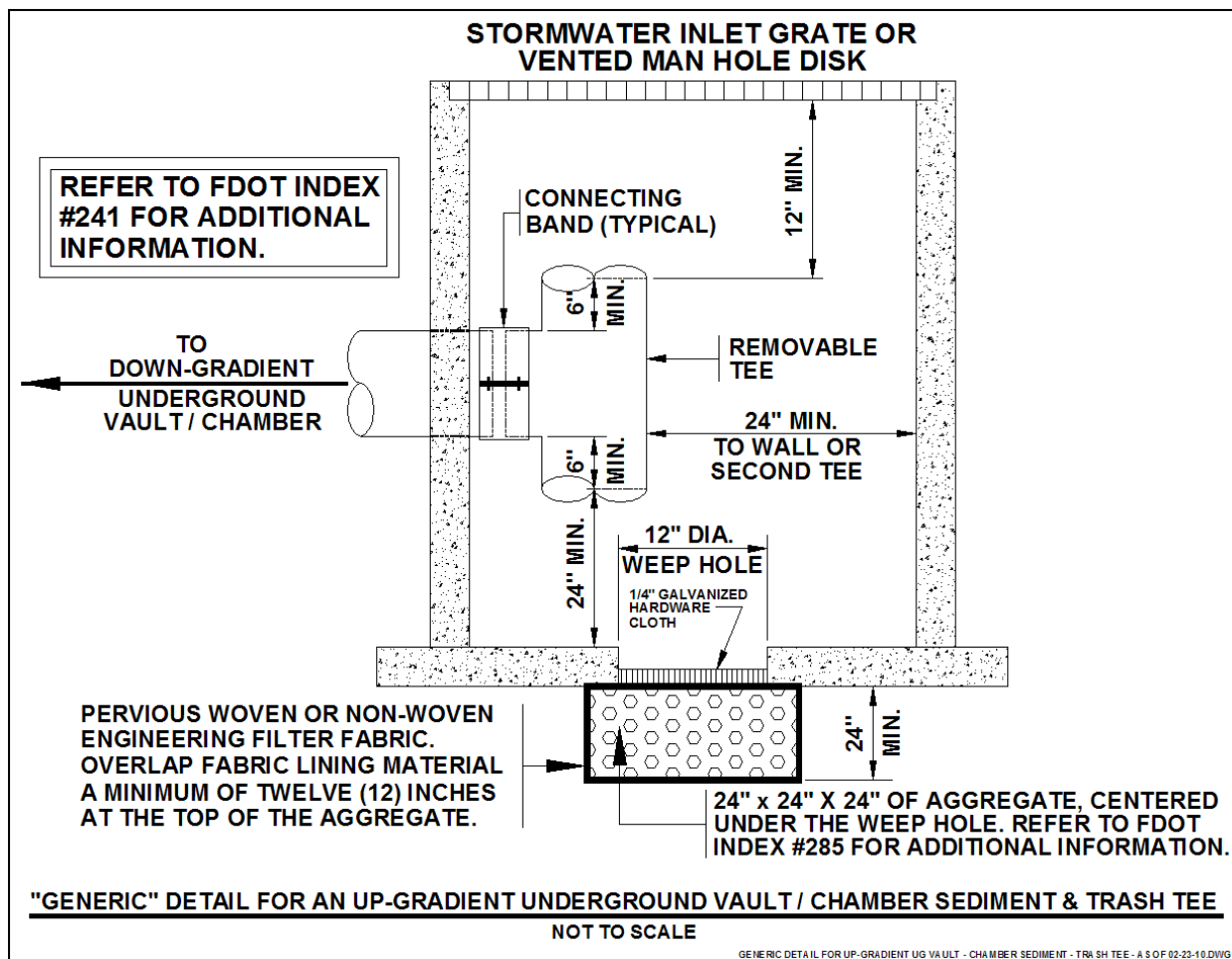

Figure 8.2 Generic Detail for an Up-Gradient Underground Vault/Chamber System Sediment & Trash Baffle



**Figure 8.3 Alternate Generic Detail for an Up-Gradient Underground Vault/Chamber System Sediment & Trash Tee**

**8.6 Inspections, Operation and Maintenance Requirements**

**(a) General**

Regular, routine inspection and maintenance is an important component of this type of underground system to ensure that it functions in a satisfactory manner. The maintenance intervals for an underground vault/chamber are typically more frequent than standard “dry” retention ponds. The performance of the underground system will be related to the effectiveness of the up-gradient sediment/trash removal devices (refer to **Figures 8.2 and 8.3**), and the frequency of inspections and maintenance activities for all of the vault/chamber system components.

The guidelines outlined below are intended to provide a comprehensive schedule that gives reasonable assurance that regulatory agency requirements and recommendations are being met.

(b) Indication of system failure:

Standing water over sub-grade soils at the bottom of the underground vault/chamber more than 72 hours after a storm event typically indicates system failure. Long term system failures are generally the result of inadequate or improper O&M procedures within the up-gradient sediment/trash removal devices, and/or within the underground vault/chamber system itself.

(c) Sub-grade Soil Maintenance

The sub-grade soils at the bottom of this system are the only mechanism to provide water quality treatment (soil infiltration of the RTV). Therefore, the designed hydraulic conductivity rates within this soil must be maintained. Inspection ports, observation wells, and access manholes/trench grates are provided to facilitate ongoing inspection and maintenance activities. Failure to repair inflow or outflow scour erosion damage, or to remove detrimental materials (i.e., trash, clays, limerock debris, organic matter, etc.), will result in lower soil hydraulic conductivity rates, and subsequent system failure. Manual methods can be used for this required maintenance. However, the use of a vacuum truck for contaminate removal may be a more practical means of providing for the removal of these detrimental materials and sediments. Disposal of these contaminants shall be in an approved landfill facility.

(d) Access Portals

All security and access features of the underground system should be checked periodically. Access manholes and trench grates should have secure bolted lids and grates to prevent unauthorized access to the underground system. If applicable, the associated ladder rungs will need to be checked to ensure that they are securely anchored to the system's walls. When inspection ports or access manholes / grates are open for maintenance and inspection, the opening shall be protected by a temporary railing / barrier / cover, etc., to prevent an accidental fall through the opening, along with providing for a safe environment for maintenance personnel.

(e) Inspection and Maintenance Schedule

- (1) **After a large storm event [greater than one (1) inch of rainfall]:** To ensure the (continued) free flow of stormwater, inspect the system and remove accumulated trash and debris from the up-gradient sediment / trash removal devices, and the inflow and outflow points of the down-gradient underground vault/chamber system.
- (2) **Every 6 months:** Perform a comprehensive inspection of the underground system for accumulated trash, debris and organic matter, and remove these materials to ensure unimpeded stormwater flow. As appropriate, clean the surface of the sub-grade sands by raking, and check for accumulations in the various underground areas. If the sediment or debris accumulation is greater than two (2) inches, a vacuum truck or similar equipment may be necessary for removal operations. Removed materials shall be taken to an approved offsite landfill.
- (3) **Annually, during September:** Monitoring of the drawdown time for the stormwater through the sub-grade sands shall be done to ensure recovery within 72 hours after the last rainfall event. Monitoring and observation of the drawdown times can be done visually through the inspection ports or observation well after a

storm event. The drawdown of the water quality treatment volume (RTV) must recover within 72 hours after the storm event. If appropriate, post-construction hydraulic conductivity testing of the non-compacted soil floor [and their subsequent (certified) reports] shall be performed by the appropriate Florida licensed professional. Any post-construction soil testing reports shall be submitted to the Agency upon request.

- (4) Drawdown times that exceed 72 hours are indicative of sub-grade clogging, and will require the removal of contaminants and raking of the sub-grade soils. The actual depth of removal can be done visually by looking at the discoloration of the entrapped fine silts, hydrocarbons (greases, oils), and organic matter. If required, replacement sub-grade soils must meet the design specifications under the original permit authorization.
- (5) In addition to the sub-grade soils, other elements of the stormwater management system such as pipes, inlets, geotextile fabric, gravel, sediment / trash removal devices, etc., are to be inspected and appropriate maintenance activities conducted to assure that the system continues to operate as permitted.

## 9.0 SWALES

### 9.1 *Description*

Swales have been used for conveyance of stormwater along roads for decades. However, swales can also be used for stormwater treatment, especially as part of a BMP Treatment Train, when properly designed and maintained to provide retention and infiltration of stormwater.

Swales are defined in Chapter 403.803(14), Florida Statutes, as follows:

“Swale means a manmade trench which:

1. Has a top width to depth ratio of the cross-section equal to or greater than 6:1, or side slopes equal to or flatter than 3 feet horizontal to 1-foot vertical;
2. Contains contiguous areas of standing or flowing water only following a rainfall event;
3. Is planted with or has stabilized vegetation suitable for soil stabilization, stormwater treatment, and nutrient uptake; and
4. Is designed to take into account the soil erodibility, soil percolation, slope, slope length, and drainage area so as to prevent erosion and reduce pollutant concentration of any discharge.”

Swales are online retention systems and their treatment effectiveness is directly related to the amount of the annual stormwater volume that is infiltrated. Swales designed for stormwater treatment can be classified into two categories:

- Swales with swale blocks or raised driveway culverts
- Swales without swale blocks or raised driveway culverts

### 9.2 *Swales with Swale Blocks or Raised Driveway Culverts (Linear Retention Systems)*

A swale with swale blocks or raised driveway culverts essentially is a linear retention system in which the treatment volume is retained and allowed to percolate. The treatment volume necessary to achieve the required treatment efficiency shall be routed to the swale and percolated into the ground before discharge. Linear retention swales are designed following the requirements in **Section 5** and the design criteria specific to swales in **Section 9.4** of this Handbook. This type of swale system is recommended when multiple inflows occur to a swale.

### 9.3 *Swales without Swale Blocks or Raised Driveway Culverts (Conveyance Swales)*

Conveyance swales are designed and constructed to required dimensions to properly convey and infiltrate stormwater runoff as it travels through the swale. Conveyance swales may be useable in some projects as part of a BMP treatment train to provide pre-treatment of runoff before its release into another BMP depending upon the site conditions, the location of inflows, and the land use plan. These swales are designed to infiltrate a defined quantity of runoff (the treatment volume) through the permeable soils of the swale floor and side slopes into the shallow ground water aquifer immediately following a storm event (**Figure 9.1**). Turf or other acceptable vegetation is established to prevent erosion, promote infiltration and stabilize the bottom and side slopes. Soil permeability and water table conditions must be such that the swale can percolate the required runoff volume. The swale holds water only during and immediately after a storm event, thus the system is normally “dry.” These types of swales are “open” conveyance systems. This means there are no physical barriers such as swale blocks or raised driveway culverts to impound the runoff in the swale prior to discharge to the receiving water. In these types of swales, the inflow of stormwater occurs at the “top” of the swale system and the retention volume and associated stormwater treatment credit is based on the infiltration that occurs as the stormwater moves down the swale.

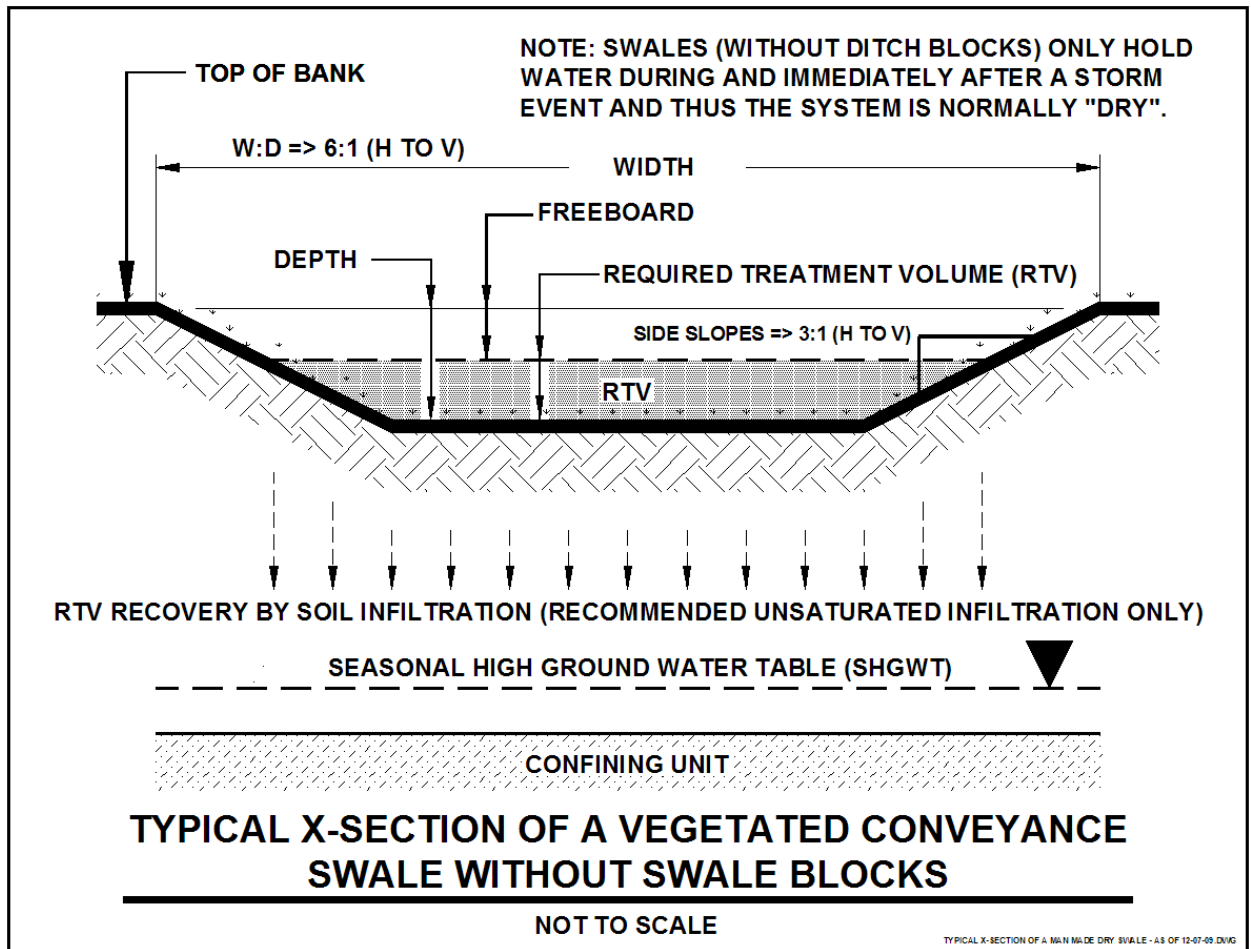

Figure 9.1 Typical Cross-section of a Conveyance Swale without Swale Blocks

### 9.3.1 Required Treatment Volume

The required nutrient load reduction will be determined by the type of water body to which the swale and associated BMP treatment train discharges and the associated performance standard as set forth in **Section 3.1** of this Handbook. The treatment volume necessary to achieve the desired treatment efficiency shall be routed to the swale and associated BMP treatment train before discharge. The nutrient load reduction credit assigned to the conveyance swale shall be based on the annual volume of stormwater that is retained in the swale and not discharged to the downstream BMP. This volume shall be calculated using the equations in **Section 9.3**.

### 9.3.2 Calculating the Swale Length

The average flow rate through the swale and the length of swale needed to percolate a given volume of stormwater can be calculated using the two equations below.

**Equation 9.3.1** Calculating the average flow rate:

This is calculated using the rational formula with the peak rate divided by 2 (average of triangular hydrograph).

$$Q = 0.5 CIA$$

Where:

C = runoff coefficient

I = rainfall intensity (inches/hour) for the time of concentration

= desired treatment volume/Time of Concentration

**Equation 9.3.2** Swale length for Trapezoidally Shaped Swales

$$L = \frac{43,200 Q}{\{B + 2 \left[ \frac{1.068 n Q (1 + Z^2)^{1/3}}{S^{1/2} Z^{2/3} 2[(1 + Z^2)^{1/2} - Z]} \right]^{3/8} (1 + Z^2)^{1/2}\} i}$$

Where K = 9900 if Z = 3  
 8500 if Z = 4  
 7500 if Z = 5  
 6750 if Z = 6  
 6150 if Z = 7

Where:

L = Length of swale (ft)

B = Bottom width (ft)

Q = Average flow rate to be percolated from Equation 9.3.1

n = Manning's Roughness Coefficient

Z = Side slope (horizontal distance for a one foot vertical change)

S = Longitudinal slope

i = Infiltration rate (inches/hour)

### 9.4 Design Criteria for Swales

- (a) Conveyance swales will be designed to infiltrate the required volume of stormwater needed to achieve the desired level of nutrient load reduction before discharging to the downstream BMP. Linear retention swales shall be designed to infiltrate the required treatment volume as for retention systems as specified in **Section 5** of this Handbook.
- (b) The seasonal high ground water table shall be at least two feet below the bottom of the swale unless the applicant demonstrates based on plans, test results, calculations or other information that a alternative design is appropriate for the specific site conditions.
- (c) The minimum infiltration rate through the vegetation and soil shall be at least one inch per hour.

- (d) The lateral slope across the bottom of the swale shall be flat to assure even sheet flow and prevent channelized flow and erosion.
- (e) Longitudinal slopes shall not be so steep as to cause erosive flow velocities.
- (f) It is recommended that the bottom of the swale be at least two feet wide to facilitate mowing.
- (g) Off-street parking or other activities that can cause rutting or soil compaction is prohibited.
- (h) Swales shall not be constructed within 50 feet of a public or private potable water supply well.
- (i) If swales are proposed within Sensitive Karst Areas, they shall be designed in accordance with the requirements in **Section 29** of this Handbook.

### **9.5 *Soil Requirements and Testing Requirements***

Swales shall be constructed on soils which are capable of infiltrating the required treatment volume. Geo-technical testing of the underlying soil will be required to establish the depth to the Seasonal High Ground Water Table (SHGWT), the limiting infiltration rate (constant rate with time), and identification of the location of close-to-surface impermeable materials or layers that may require re-location of the swale. Details related to safety factors, recovery/mounding analysis and supporting soil testing is provided in **Section 21** of this Handbook.

### **9.6 *Construction and Stabilization Requirements***

The following construction procedures are required to avoid degradation of the swale's infiltration capacity due to construction practices:

- (a) The location and dimensions of the swale system shall be verified onsite prior to its construction. All design requirements including swale dimensions and distances to foundations, septic systems, and wells need to be verified.
- (b) The location of swales shall be clearly marked at the site to prevent unnecessary vehicular traffic across the area causing soil compaction.
- (c) Excavation shall be done by lightweight equipment to minimize soil compaction. Tracked, cleated equipment does less soil compaction than equipment with tires.
- (d) Ensure that lateral and longitudinal slopes meet permitted design requirements and will not erode due to channelized flow or excessive flow rates.
- (e) Final grading and planting of the swale should not occur until the adjoining areas draining into the swale are stabilized. Any accumulation of sediments that does occur must be removed during the final stages of grading. The bottom should be tilled to produce a highly porous surface.
- (f) Ensure that measures are in place to divert runoff while vegetation is being established on the side slopes and bottom of the swale. If runoff can't be diverted, vegetation shall be established by staked sodding or by the use of erosion control blankets or other appropriate methods.



- (g) Ensure that the vegetation used in the swale is consistent with values used for Manning's "n" in the design calculations.
- (h) An applicant may propose alternative construction procedures to assure that the design infiltration rate of the constructed and stabilized swale system basin is met provided it is acceptable and approved by the Agency.

### **9.7 Inspections, Operation and Maintenance Requirements**

Maintenance issues associated with swales are related to clogging of the porous soils which reduces or prevents infiltration thereby slowing recovery of the stormwater treatment volume and often resulting in standing water. Clogging can result from sedimentation and resulting sealing of the bottom or side slope soils. It can also occur from excessive loading of oils and greases or from excessive algal or microorganism growth.

To determine if a swale is properly functioning or whether it needs maintenance requires that an inspection be done during and soon after a storm. The inspection should determine if the swale is recovering its storage volume within its permitted time frames, generally 24 to 72 hours after a storm. If this is not occurring and resulting in standing water, then the cause of must be determined and appropriate actions undertaken beginning with those specified in the system's Operation and Maintenance Plan.

#### (a) Inspection Items:

- (1) Inspect swale for storage volume recovery within the permitted time, generally less than 72 hours. Failure to percolate the required treatment volumes indicates reduction of the infiltration rate and a need to restore system permeability
- (2) Inspect and monitor sediment accumulation on the bottom of the swale or at inflows to prevent clogging of the swale or the inflow pipes.
- (3) Inspect vegetation of bottom and side slopes to assure it is healthy, maintaining coverage, and that no erosion is occurring within the swale.
- (4) Inspect the swale for potential mosquito breeding areas such as where standing water occurs after 72 hours or where cattails or other invasive vegetation becomes established.
- (5) Inspect swale to determine if filling, excavation, construction of fences, or other objects are obstructing the surface water flow in the swales.
- (6) Inspect the swale to determine if it has been damaged, whether by natural or human activities.

#### (b) Maintenance Activities As-Needed To Prolong Service:

- (1) If needed, restore infiltration capability of the swale to assure it meets permitted requirements.
- (2) Remove accumulated sediment from swale and inflow or outflows and dispose of properly. Please note that stormwater sediment disposal may be regulated under

Chapter 62-701, F.A.C. Sediment removal should be done when the swale is dry and when the sediments are cracking.

- (3) Remove trash and debris, especially from inflow or outflow structures, to prevent clogging or impeding flow.
- (4) Maintain healthy vegetative cover to prevent erosion of the swale bottom or side slopes. Mow grass as needed and remove grass clippings to reduce nutrient loadings.
- (5) Eliminate mosquito breeding habitats.
- (6) Remove fences or other obstructions that may have been built in the swale system.
- (7) Repair any damages to the swale system so that it meets permitted requirements.

## 10.0 VEGETATED NATURAL BUFFERS

### 10.1 *Description*

Vegetated natural buffers (VNBs) are defined as areas with vegetation suitable for nutrient uptake and soil stabilization that are set aside between developed areas and a receiving water or wetland for stormwater treatment purposes. Under certain conditions, VNBs are an effective best management practice for the control of nonpoint source pollutants in overland flow by providing opportunities for filtration, deposition, infiltration, absorption, adsorption, decomposition, and volatilization.

VNBs are most commonly used as an alternative to swale/ berm systems installed between backyards and the receiving water. Buffers are intended for use to avoid the difficulties associated with the construction and maintenance of backyard swales on land controlled by individual homeowners. Potential impacts to adjacent wetlands and upland natural areas are reduced because fill is not required to establish grades that direct stormwater flow from the back of the lot towards the front for collection in the primary stormwater management system. In addition, impacts are potentially reduced since buffer strips can serve as wildlife corridors, reduce noise, and reduce the potential for siltation into receiving waters.

Vegetative natural buffers are not intended to be the primary stormwater management system for residential developments. They are most commonly used only to treat those rear-lot portions of the development that cannot be feasibly routed to the system serving the roads and fronts of lots. A schematic of a typical VNB and its contributing area is presented in **Figure 10.1**. The use of a VNB in combination with a primary stormwater management system for other types of development shall only be allowed if the applicant demonstrates that there are no practical alternatives for those portions of the project, and only if the VNB and contributing areas meet all of the requirements in this section of the Handbook.

### 10.2 *Required Treatment*

The treatment volume necessary to achieve the desired or required treatment efficiency shall be routed to the Vegetated Natural Buffer and percolated into the ground. The required nutrient load reduction will be determined by type of water body to which the stormwater system discharges and the associated performance standard as set forth in **Section 3.1** of this Handbook. Treatment volumes to achieve the necessary efficiencies shall be determined based on the percentage of directly connected impervious area (DCIA) and the weighted curve number for non-DCIA areas. **Appendix D** provides dry retention depths (inches of runoff over the drainage area) in order to achieve 85 percent removals for the various meteorological regions. For post-pre calculations, **Appendix F** provides performance efficiencies for dry retention runoff volumes for the various meteorological regions.

Natural areas adjacent to rear-lots that have good infiltration potential are candidates for use as VNBs. Runoff from the rear-lot areas must be designed to percolate a specified portion of runoff as indicated below.

**Figure 10.1 Plan View Schematic of Typical Vegetative Natural Buffer**

**10.3 *Calculating Load Reduction Efficiency for a Given Retention Volume***

If Vegetated Natural Buffers are being used as part of a BMP treatment train to achieve some level of pollutant load reduction but not the total amount of the required nutrient load reduction, the tables in **Appendix F** shall be used.

#### 10.4 *Design Criteria*

- (a) Vegetated Natural Buffers shall be designed to infiltrate the required treatment volume as specified in **Section 10.2** of this Handbook.
- (b) The contributing area is defined as the area that drains to the VNB. Only rear-lots of residential areas are allowed to contribute runoff to a VNB and then only if routing the runoff from such areas to the primary stormwater management system serving the development is not practical.
- (c) The seasonal high ground water table shall be at least two feet below the bottom of the vegetated natural buffer unless the applicant demonstrates based on plans, test results, calculations or other information that an alternative design is appropriate for the specific site conditions.
- (d) The minimum infiltration rate through the vegetation and soil shall be at least one inch per hour.
- (e) The minimum buffer width (dimension parallel to flow direction) shall be 25 feet to provide adequate area for infiltration and the maximum VNB width shall be 100 feet to ensure sheet flow conditions and the integrity of the treatment system. Factors affecting the minimum width (measured parallel to the direction of runoff flow) of VNB include infiltration rate, ground slope, rainfall, cover and soil characteristics, depth to water table and overland flow length. Infiltration is the primary means of treatment in vegetated natural buffers. A sample calculation for designing a buffer to meet the above requirements is provided in **Section 28** of this Handbook
- (f) The maximum slope of VNB shall not be greater than 6:1.
- (g) The length of the buffer (measured perpendicular to the runoff flow direction) must be at least as long as the length of the contributing runoff area (see **Figure 10.1**).
- (h) Runoff from the adjacent contributing area must be evenly distributed across the buffer strip to promote overland sheet flow. If the flow regime changes from overland to shallow concentrated flow, the buffer is effectively “short-circuited” and will not perform as designed.
- (i) The Property Association Documents and Conditions Covenants and Restrictions (CC&R’s) will require that the contributing area must be stabilized with permanent vegetative cover that is consistent with the Florida Friendly Landscaping program and which is fertilized only with Florida-friendly fertilizers.
- (j) A legal reservation, in the form of an easement or other limitation of use, must be recorded which provides preservation of entire area of the Vegetated Natural Buffer. The reservation must also include access for maintenance of the VNB unless the operation and maintenance entity wholly owns or retains ownership of the property.
- (k) The VNB area will be an existing undeveloped area which contains existing or planted vegetation suitable for infiltrating stormwater and soil stabilization. The existing vegetation must not be disturbed during or after the construction of the project. If the VNB will be planted, the proposed list of Florida-friendly plants must be submitted to the Agency for

review. Maintenance shall assure that the VNB contains less than 10 percent coverage by exotic or nuisance plant species.

- (l) Erosion control measures such as those described in **Part IV** of this Handbook must be used during development of the contributing area so as to prevent erosion or sedimentation of the vegetated natural buffer.
- (m) Vegetated natural buffers shall not be constructed within 50 feet of a public or private potable water supply well.
- (n) The vegetated natural buffer and any required wetland buffer can be the same area provided that the functions and regulatory requirements for each are met.

### ***10.5 Required Site Information***

Successful design of a Vegetated Natural Buffer system depends heavily upon conditions at the site, especially information about the soil, geology, and water table conditions. Specific data and analyses required for the design of a retention system are set forth in **Section 21** of this Handbook.

### ***10.6 Construction requirements***

The following construction procedures are required to protect the Vegetated Natural Buffer during planting, if needed, and to avoid degradation of the VNB due to construction of the adjacent contributing area:

- (a) The location and dimensions of the VNB shall be verified onsite prior to any construction. All design requirements including VNB dimensions and distances to foundations, septic systems, wells, etc. need to be verified.
- (b) The VNB shall be clearly marked at the site to prevent equipment or vehicular traffic from entering the VNB (if a natural area) or to minimize compaction from any equipment entering the VNB during planting or establishment.
- (c) Ensure that the VNB buffer length, width, and slopes meet permitted design requirements
- (d) Ensure that the VNB will not erode due to channelized flow or excessive flow rates.
- (e) Ensure that measures are in place to divert runoff from the VNB while the adjacent contributing area is being cleared and established. The adjacent contributing area shall be stabilized as quickly as possible by sodding or by the use of erosion control blankets or other appropriate methods.
- (g) Ensure that the vegetation planted in the VNB and adjacent contributing area meets Florida-friendly landscaping requirements as specified in the permitted design.

### ***10.7 Inspections, Operation and Maintenance***

Maintenance issues associated with Vegetated Natural Buffers are related to integrity of the VNB and damage to the natural or planted vegetation or the infiltration capabilities within the VNB. To determine if the VNB is properly functioning or whether it needs maintenance requires that an inspection be done during and soon after a storm. The inspection should determine if the VNB is

providing sheetflow and infiltration of the required treatment volume within its permitted time frames, generally 24 to 72 hours after a storm. If this is not occurring, then the cause of must be determined and appropriate actions undertaken beginning with those specified in the system's Operation and Maintenance Plan.

VNBs must be inspected annually by the operation and maintenance entity to determine if there has been any encroachment or violation of the terms and condition of the VNB as described below. Reports documenting the results of annual inspections shall be filed with the Agency every three years, or upon discovery of any encroachment or violation of design parameters, whichever occurs first.

(a) Inspection Items:

- (1) Inspect VNB for storage volume recovery within the permitted time, generally less than 72 hours. Failure to percolate the required treatment volumes indicates reduction of the infiltration rate and a need to restore system permeability.
- (2) Inspect VNB to assure that inflow is via sheetflow, for areas of channelized flow through or around the buffer, and for areas with erosion or sediment accumulation indicating channelized flow or that stabilization of the adjacent contributing area is needed.
- (3) Inspect VNB for damage by foot or vehicular traffic or encroachment by adjacent property owners.
- (4) Inspect VNB for the health and density of vegetation, and for the occurrence of exotic or nuisance plant species.

(b) Maintenance Activities As-Needed To Prolong Service:

- (1) If needed, restore infiltration capability of the VNB to assure it meets permitted requirements.
- (2) Repair any areas where channelized flow is occurring and restore sheetflow.
- (3) Repair any areas with erosion and carefully remove accumulated sediments if needed to assure the health and functioning of the VNB
- (4) Stabilize eroding parts of the adjacent contributing area as needed to prevent erosion and sedimentation.
- (5) Repair any damage to the VNB by foot or vehicular traffic and remove any fences or other materials that have been placed in the VNB by adjacent property owners.
- (6) Maintain the VNB vegetation and, if necessary, replant the VNB with approved Florida-friendly vegetation as needed to assure sheet flow and prevent erosion and sedimentation. Maintenance of exotic or nuisance species within the VNB is not required but their removal is recommended.

All repairs to the VNB must be made as soon as practical in order to prevent additional damage to the buffer. Repaired areas must be re-established with approved Florida-friendly or native vegetation.



## 11.0 PERVIOUS PAVEMENT SYSTEMS

### 11.1 *Description*

Pervious pavement systems include the subsoil, the sub-base, and the pervious pavement (**Figure 11.1**). They can include several types of materials or designed systems such as pervious concrete, pervious aggregate/binder products, pervious paver systems, and modular paver systems. Pervious asphalt and pervious pavements using crushed and recycled glass will not be allowed until future improvements are made and verified with testing to address their structural capability, hydraulic performance and manufacturing process. Recent studies on the design, longevity, and infiltration characteristics of pervious pavement systems are available on the University of Central Florida's website <http://stormwater.ucf.edu/>.

Pervious pavement systems are retention systems. They should be used as part of a treatment train to reduce stormwater volume and pollutant load from parking lots, or similar types of areas. As with all infiltration BMPs, the treatment efficiency is based on the amount of the annual runoff volume infiltrated which depends on the available storage volume within the pavement system, the underlying soil permeability, and the ability of the system to readily recover this volume.

### 11.2 *Applicability*

Pervious pavement systems can be used for many impervious applications (i.e. sidewalks, driveways, on-street parking) but they primarily are used in parking lots, especially the parking stalls. The designer must consider the limitations of the pervious pavement system application in determining its proper application. In addition, the designer must consider various site conditions and potential challenges including:

- (a) Poorly draining soils such as those with shallow Seasonal High Ground Water Tables (SHGWTs), shallow confining units (i.e., clays/hardpans), organic mucks, etc.
- (b) In areas subject to high traffic volumes, regardless of wheel loads. It is recommended that:
  1. The number of vehicles using a pervious pavement parking stall should not exceed one hundred (100) vehicles per day for most pervious pavement systems.
  2. Traditional Class I concrete, brick pavers or an appropriate asphalt section should be used in areas subject to high traffic volumes such as the primary driving areas within a parking lot.
- (c) Regardless of wheel loads, pervious pavement should not be used on areas of frequent turning movements (public roadways, drive thru lanes, around gas pumps, adjacent to dumpster pads, driveway entrances, etc.). It is recommended that traditional Class I concrete, brick pavers or an appropriate asphalt section be used in these areas.
- (d) If pervious pavement is proposed for areas with heavy wheel loads or other non-recommended conditions, then the applicant shall be required to use alternate methods of pavement design. This may include using imported (hydraulically clean) soils, structural/permeable geo-fabrics, thicker pervious pavement sections, etc. above the parent soil. Hydraulically clean soils will be defined as those that are free of materials (clays, organics, etc.) that will impede the soil's saturated vertical and horizontal hydraulic conductivity.

- (e) Pervious pavements shall not be used in areas with high potential for hazardous material spills that could seep into the underlying ground water. Examples of these areas include (but are not limited to) auto maintenance facilities, auto parts stores that are subject to on-site installation of hazardous materials by customers/store personnel, chemical plants, etc.
- (f) Certain pervious pavement systems may create the potential for tripping hazards that needs to be considered **when designing areas used by pedestrians.**

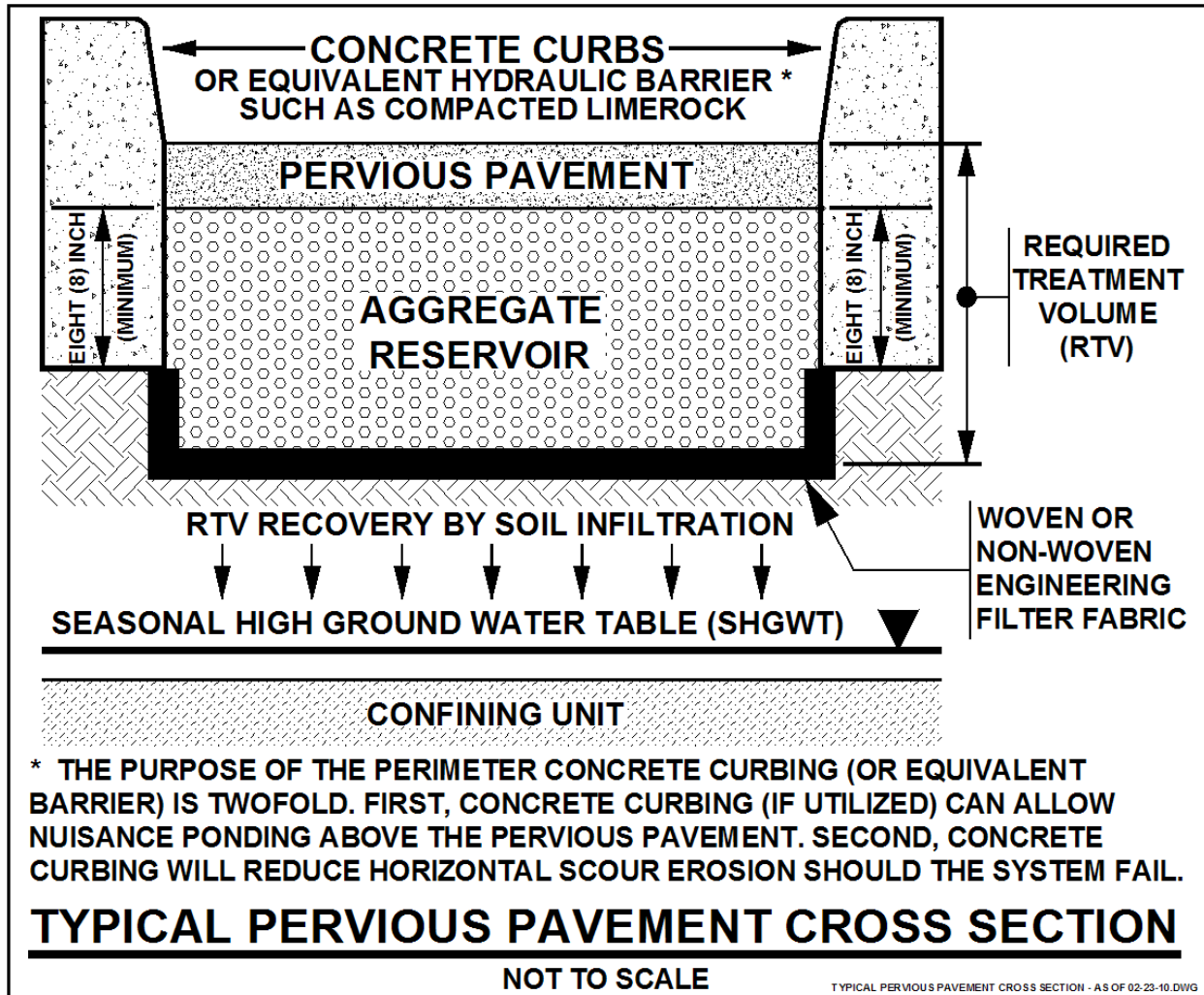

Figure 10.1 – Typical Pervious Pavement Cross Section

### 11.3 Required Treatment Volume

The treatment volume necessary to achieve the required treatment efficiency shall be routed to the pervious pavement system and percolated into the ground. The required nutrient load reduction will be determined by type of water body to which the stormwater system discharges and the associated performance standard as set forth in **Section 3.1** of this Handbook. Treatment volumes to achieve the necessary efficiencies shall be determined based on the percentage of directly

connected impervious area (DCIA) and the weighted curve number for non-DCIA areas. **Appendix D** provides dry retention depths (inches of runoff over the drainage area) in order to achieve 85 percent removals for the various meteorological regions. For post=pre calculations, **Appendix F** provides performance efficiencies for dry retention runoff volumes for the various meteorological regions.

#### **11.4 Calculating Load Reduction Efficiency for a Given Retention Volume**

If pervious pavement systems are being used as part of a BMP treatment train to achieve some level of pollutant load reduction but not the total amount of the required nutrient load reduction, the tables in **Appendix F** shall be used.

#### **11.5 Design Criteria**

Pervious pavement system design has two major components: structural and hydraulic. The pervious pavement system must be able to support the traffic loading while also (and equally important) functioning properly hydraulically. This section does NOT discuss structural designs of pervious pavement systems. ERP applicants (and their engineering consultants) should consult the product manufacturer's pavement design standards to ensure that pervious pavements will be structurally stable, and not be subject to premature deterioration failure.

Below are the types of practices, specifications, recommendations, tools and potential conditions for applicants to consider for the approval of pervious pavement systems. This is not intended to cover all potential designs. Professional judgment must be used in the design and review of proposed pervious pavement systems.

- (a) Pervious pavement systems must have the capacity to retain the required treatment volume without a discharge and without considering soil storage.
- (b) The applicant must provide reasonable assurances that the pervious pavement construction will be performed by a contractor trained and certified by the product manufacturer to install the proposed pervious pavement system. To accomplish this requirement, the applicant must supply documentation of the appropriate contractor certification as part of the ERP application process. If the pervious pavement contractor is not known at the time of ERP application submittal, a special condition shall be placed in the ERP to require submittal of the contractor's certification prior to construction commencement.
- (c) The seasonal high ground water table shall be at least two feet beneath the bottom of the pervious pavement system unless the applicant demonstrates, based on plans, test results, calculations or other information, that an alternative design is appropriate for the specific site conditions. The "system" is defined as the pervious pavement itself, the underlying storage reservoir, if used (i.e., pea rock, #57 stone, etc.), and the geo-fabric that wraps the underlying storage reservoir (refer to **Figures 11.1** through **11.4** for additional information).
- (d) The pervious pavement system must provide the capacity for the recovery of the required treatment volume of stormwater within 72 hours, with a safety factor of two, assuming average Antecedent Runoff Condition (ARC 2). In a pervious pavement system, the stormwater is drawn down by natural soil infiltration and dissipation into the ground water table, as opposed to underdrain systems which rely on artificial methods like perforated or slotted drainage pipes. A drawdown or recovery analysis is required that accounts for the mounding of ground

water beneath the pervious pavement system. Details related to safety factors, recovery/mounding analysis and supporting soil testing is provided in **Section 21** of this Handbook.

- (f) The minimum vertical hydraulic conductivity of the pervious pavement system shall not be less than 2.0 inches per hour.
- (g) Pervious pavement systems shall not be constructed within 50 feet of a public or private potable water supply well.
- (h) The in-situ (or imported) subgrade soil (below the pervious pavement system) shall be compacted to a maximum of 92% - 95% Modified Proctor density (ASTM D-1557) to a minimum depth of 24 inches. For proposed pervious pavements within redevelopment projects, the existing pavement section and its compacted base shall be removed. The underlying soils are to be scarified to a minimum 16 inch depth, re-graded, filled with hydraulically clean soils (if applicable) and proof rolled to a maximum compaction of 92% - 95% Modified Proctor density (ASTM D-1557).
- (i) Other than pedestrian walks, bicycle paths and driveway ingress or egress areas, the maximum slope for pervious pavements is 1/8 inch per foot (1.04%) although zero % slope is preferred. Steeper slopes (greater than 1/8 inch per foot) will be considered by the Agency but must be justified by the applicant as part of the ERP application process by providing plans, monitoring data, test results, or other information that demonstrates that the steeper slopes are appropriate for the specific site conditions and provides equivalent treatment and protection. The primary issue of concern is the hydraulic ability of the pervious pavement system to percolate the Required Treatment Volume (RTV) into the underlying sub-soil.
- (j) Except for pervious walks and bike paths, curbing, edge constraint or other equivalent hydraulic barrier will be required around the pervious pavement to a minimum depth of eight (8) inches beneath the bottom of the pavement and to the depth necessary to prevent scouring from the horizontal movement of water below the pavement surface depending on the adjacent slopes. Refer to **Figures 11.1 through 11.4** for additional information. The horizontal movement of water can cause scour failure at the edge of the pervious pavement system, or mask the hydraulic failure of the system due to plugging of the deeper voids in the pervious pavement or aggregate reservoir. The cross sectional construction drawings of the pervious pavement system and its relationship to the slopes of adjacent areas must include a demonstration that the depth of the curbing, edge constraint or other equivalent hydraulic barrier is sufficient to prevent erosion and scour. As an option, the delineated areas of nuisance ponding can be shown on the supporting ERP application sketches or drawings.
- (k) To provide an indicator that the pervious pavement system has failed or needs maintenance, the system shall be designed to allow a minimum ponding depth of one (1) inch and a maximum ponding depth of two (2) inches prior to down-gradient discharge with the exception of pervious walks and bicycle paths (see **Figures 11.2 through 11.4**). The permitted construction plans shall delineate the areas of pervious pavement that may be subject to nuisance ponding. As an option, the delineated areas of nuisance ponding can be shown on the supporting ERP application sketches or drawings.

- (l) The pervious pavement system must be designed to have an overflow at the nuisance ponding elevation to the down-gradient stormwater treatment or attenuation system or outfall (see **Figures 11.2** through **11.4**).
- (m) Runoff from adjacent landscaped areas must NOT be directed onto pervious pavement system areas unless the Applicant demonstrates that the offsite areas that drain onto the pervious pavement will not increase sediment, silt, sand, or organic debris that increases the potential for clogging the pervious pavement. The design must reduce the likelihood of silts and sands from plugging the pavement void spaces (see **Figures 11.7** through **11.9**).
- (n) With the exception of pervious walks and bicycle paths, the installation of Embedded Ring Infiltrometer Kit (ERIK) is required (see **Figures 11.5** and **11.6**). A minimum one (1) ERIK in-situ infiltrometer will be required for each section of pervious pavement installed. For larger sections, a minimum of two (2) in-situ ERIK infiltrometers per acre of pervious pavement will be required. ERIK Infiltrometers shall not be placed at locations where subsequent testing may produce nonrepresentative conclusions regarding the hydraulic function of the pervious pavement system. The location of the ERIK infiltrometers shall be shown on the construction plans or other supporting sketches or drawings for the project.
- (o) Documentation of ERIK infiltrometer construction, and post-construction testing, shall be required with submittal of the construction completion certification. Test results shall be provided in report form, certified by the appropriate Florida Registered Professional. The construction completion certification shall not be accepted if the vertical hydraulic conductivity is less than 2.0 inches per hour or is less than the permitted design percolation rate in any of the required ERIK infiltrometers.
- (p) For proper maintenance of most pervious pavement systems, periodic vacuum sweeping is recommended. If ERIK tests indicate a vertical hydraulic conductivity rate less than 2.0 inches per hour, or is less than the permitted design percolation rate, or when nuisance ponding occurs, vacuum sweeping will be required. Vacuum sweeping also will be required for areas that are subject to wind transported soils (near sand dunes or other coastal areas) or other conditions where excessive soil or other debris deposition is expected to occur (from adjacent landscaping mulch and leaf litter, from areas with high leaf fall, fugitive sands and limerock fines from adjacent construction sites). Vacuum sweeping will be required annually.
- (q) A remediation plan shall be submitted to the Agency for implementation by the permittee should vacuum sweeping fail to improve the vertical hydraulic conductivity to a rate greater than 2.0 inches per hour, or equal to or greater than the permitted design percolation rate, or resolve the nuisance ponding. The remediation plan shall be prepared and submitted to the Agency's compliance staff for review and approval. Maintenance records shall be retained by the permittee and made available to the Agency as part of the required O&M re-inspections and certifications.
- (r) The entrances to pervious pavement areas shall be posted by signs to inform users they are entering a pervious pavement area and that any vehicles with heavy wheel loads or with muddy tires should not enter.
- (s) Water quality credit for pervious pavement walks and bicycle paths:

For the purposes of this section, pervious pavement walks and bicycle paths refer to linear pathways and excludes areas such as courtyards and patio areas. To encourage the use of pervious pavement, the following credits are established for pervious pavement walks and bicycle paths:

1. For soils with SHGWT depths of 0” to 18” below the bottom of the pervious pavement system, 80% of the pervious pedestrian walk and bike path areas can be subtracted from the total contributing area when computing the project’s required treatment volume.
2. For soils with SHGWT depths greater than 18” below the bottom of the pervious pavement system, 100% of the pervious pedestrian walk and bike path areas can be subtracted from the total contributing area when computing the project’s required treatment volume.

To receive this credit, pervious walks and bicycle paths must be placed over native upland soils (excluding wetlands) or clean fill. For redevelopment projects, the pervious walks and paths must be placed over rehabilitated soils as described in (g) above.

For walks and paths that are properly designed and constructed pursuant to these design criteria, vacuum sweeping, remediation plans and ongoing O&M re-inspections and certifications will not (normally) be required

#### **11.6 Required Site Information**

Successful design of a pervious pavement system depends heavily upon conditions at the site, especially information about the soil, geology, and water table conditions. Specific data and analyses required for the design of a pervious pavement system are set forth in **Section 21** of this Handbook.

#### **11.7 Construction requirements**

The following construction procedures are required to assure that the pervious pavement is properly prepared and installed such that the desired infiltration rate is obtained:

- (a) The location and dimensions of the pervious pavement shall be verified onsite prior to its construction. All design requirements including pervious pavement dimensions and distances to foundations, septic systems, and wells need to be verified.
- (b) The location of pervious pavement areas shall be clearly marked at the site to prevent unnecessary vehicular traffic across the area causing soil compaction.
- (c) Excavation shall be done by lightweight equipment to minimize soil compaction. Tracked, cleated equipment does less soil compaction than equipment with tires.
- (d) Once the subgrade elevation has been reached, the area shall be inspected for materials that could puncture or tear the filter fabric, such as tree roots, and assure they are not present.
- (e) The in-situ (or imported) subgrade soil (below the pervious pavement system) shall be compacted to a maximum of 92% - 95% Modified Proctor density (ASTM D-1557) to a minimum depth of 24 inches.

- (f) The specified filter fabric shall be installed in accordance with the design specifications.
- (g) The aggregate material shall be inspected prior to placement to ensure it meets size specifications and is washed to minimize fines and debris. It should be spread uniformly to the appropriate thickness.
- (h) The pervious pavement material shall be installed by contractor trained and certified by the product manufacturer to install the proposed pervious pavement system according to approved design specifications. When pervious pavements are being used, the mix shall be tested to assure it meets specifications before it is accepted and poured.
- (i) Stormwater shall not be directed onto the pervious pavement from adjacent contributing areas until after they are stabilized to prevent sediment from entering and clogging the pervious pavement.
- (j) Before the pervious pavement is placed into operation, signs shall be installed at all entrances advising users that they are entering a pervious pavement parking lot and that vehicles with heavy wheel loads or muddy tires should not enter.
- (k) An applicant may propose alternative construction procedures to assure that the design infiltration rate of the pervious pavements are met.

### **11.8 Inspection, Operation and Maintenance**

Maintenance issues associated with pervious pavements are related to clogging of the porous surfaces which reduces or prevents infiltration thereby slowing recovery of the stormwater treatment volume and often resulting in standing water and the designed nuisance flooding.

To determine if the pervious pavement is properly functioning or whether it needs maintenance requires that either an inspection be within 72 hours of a storm and that the ERIK devices be used to test the infiltration rate as specified below.

#### **(a) Inspection Items:**

- (1) Inspect pervious pavement for storage volume recovery within the permitted time, generally less than 72 hours. Determine if nuisance flooding is occurring in those areas of the parking lot that were designed to flood if the pervious pavement was failing. Nuisance flooding indicates that the required treatment volume is not infiltrating because of a reduction of the infiltration rate and a need to restore system permeability
- (2) Use the ERIK infiltrometers at least once every two (2) years to test if the vertical hydraulic conductivity is less than 2.0 inches per hour or is less than the permitted design percolation rate in any of the required ERIK infiltrometers. If any of the ERIK infiltrometers have rates less than the permitted rate, maintenance activities shall be undertaken to restore the permeability of the pervious pavement. The results of the ERIK infiltrometer testing shall be submitted to the Agency.
- (3) Inspect all edge constraints and overflow areas to determine if any erosion is occurring and repair as needed.

(b) Maintenance Activities As-Needed To Prolong Service:

- (1) Vacuum sweeping will be conducted annually and whenever the vertical hydraulic conductivity is less than 2.0 inches per hour or is less than the permitted design percolation rate in any of the required ERIK infiltrometers. Vacuum sweeping will be done on an as-needed basis on pervious pavements located in areas that are subject to wind transported soils (near sand dunes or other coastal areas) or other conditions where excessive soil or other debris deposition is expected to occur (from adjacent landscaping mulch and leaf litter, from areas with high leaf fall, fugitive sands and limerock fines from adjacent construction sites, etc.).
- (2) A remediation plan shall be submitted to the Agency should vacuum sweeping fail to improve the vertical hydraulic conductivity to a rate greater than 2.0 inches per hour, or equal to or greater than the permitted design percolation rate, or resolve the nuisance ponding. The remediation plan shall be prepared and submitted to the Agency's compliance staff for review and approval.
- (3) Repair erosion near edge constraints or overflows and assure that the contributing drainage area is stabilized and not a source of sediments.

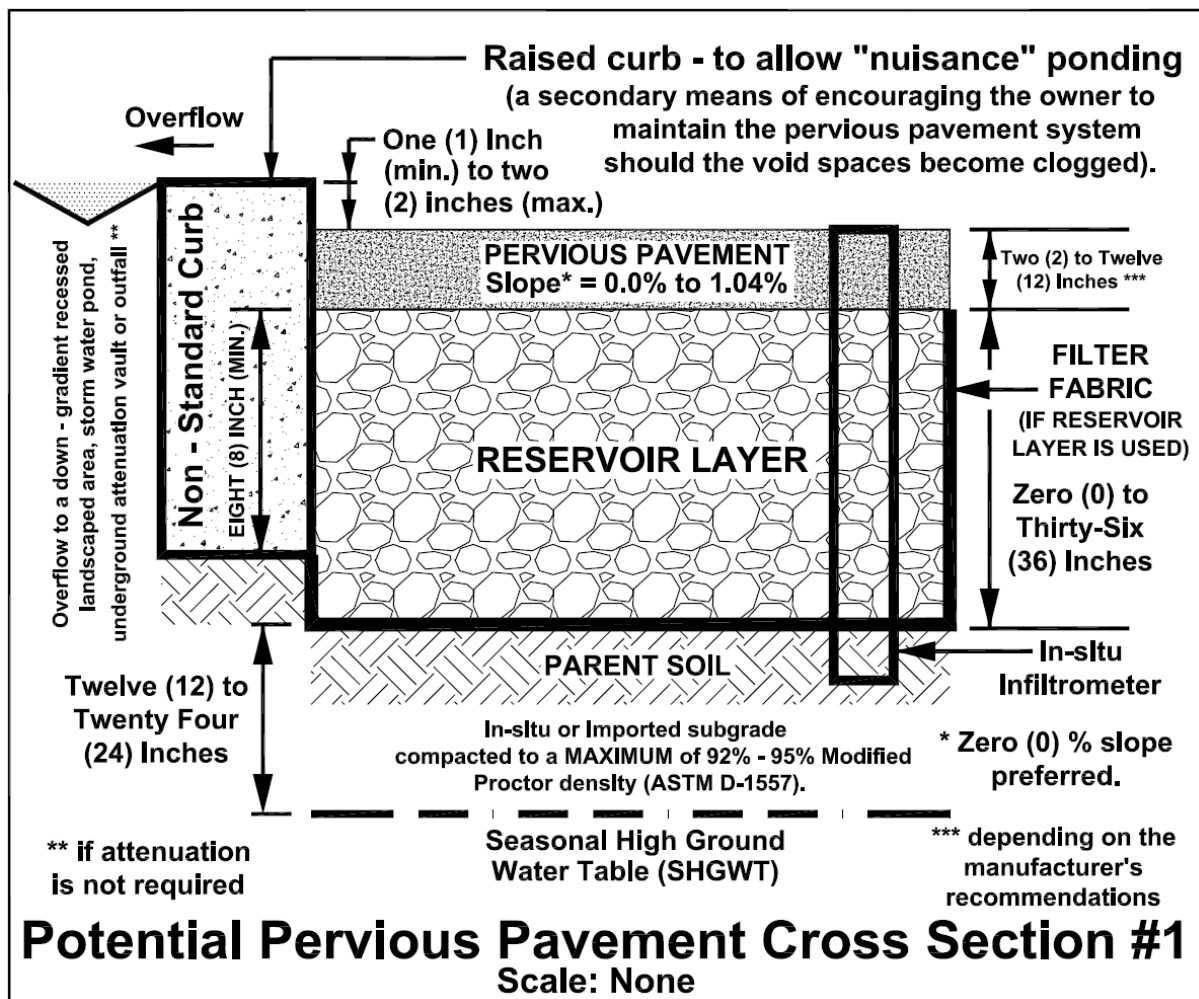

Figure 11.2 - Pervious Pavement System Cross Section #1



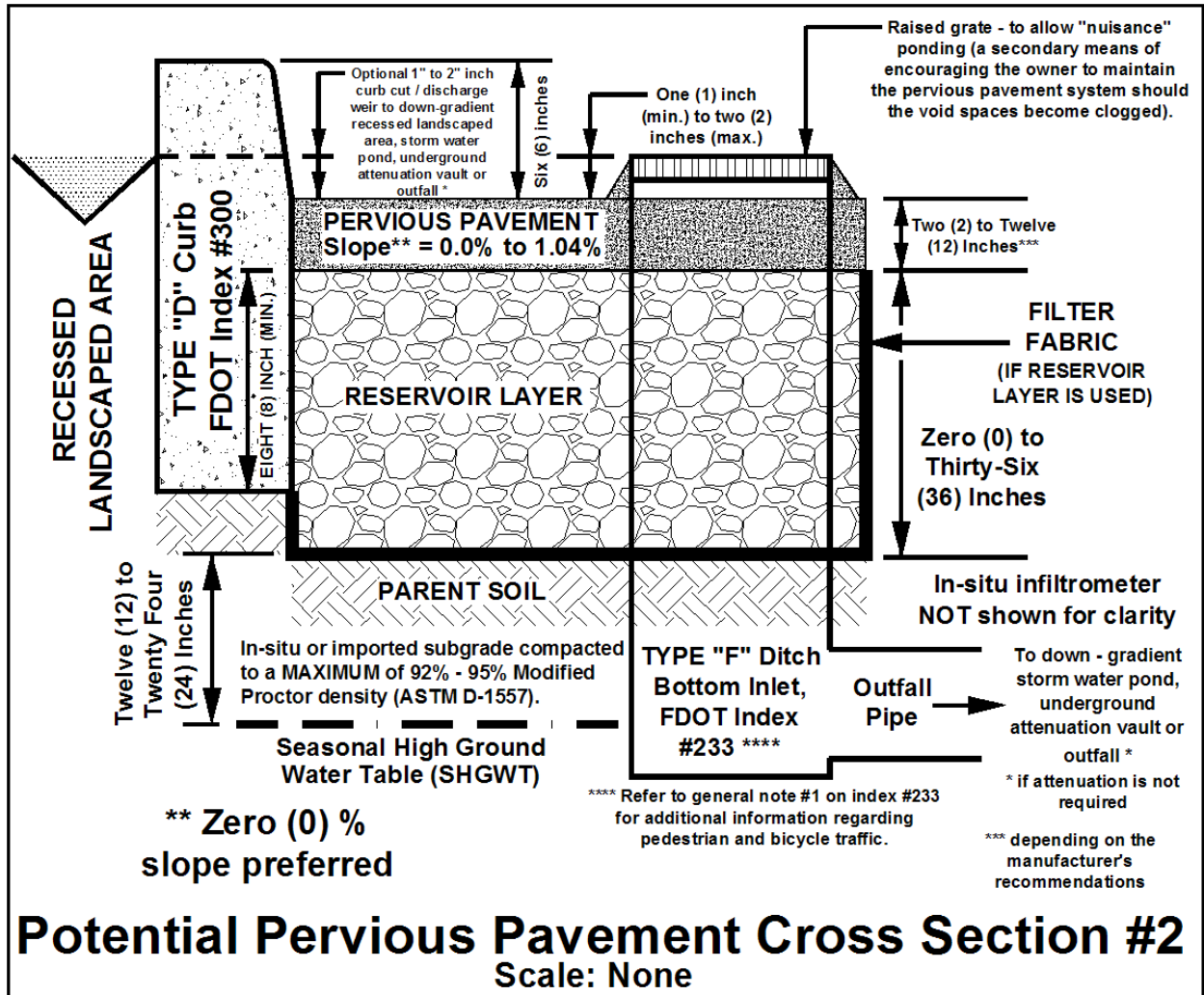

Figure 11.3 - Pervious Pavement System Cross Section #2

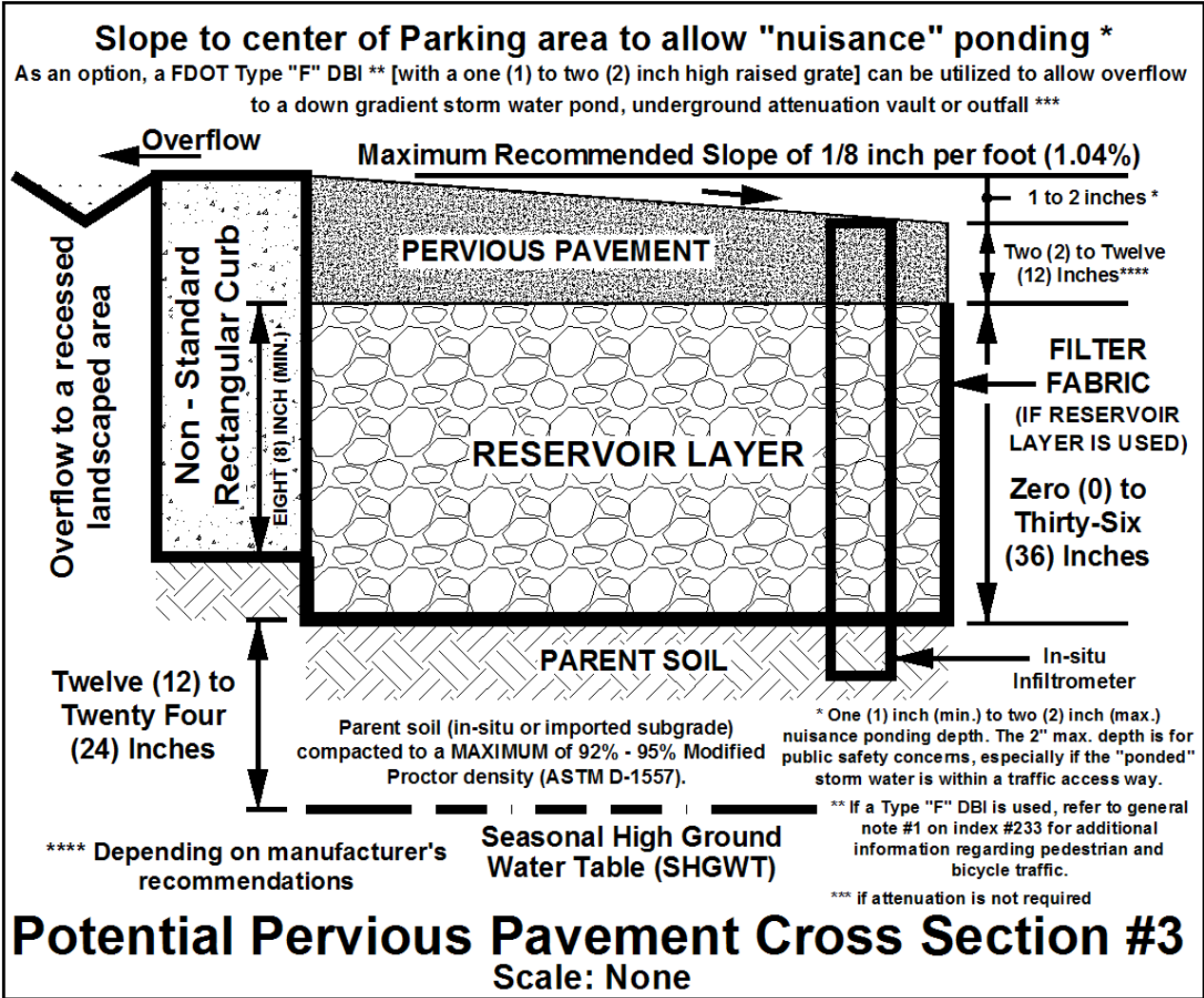

Figure 11.4 – Typical Pervious Pavement System Cross Section

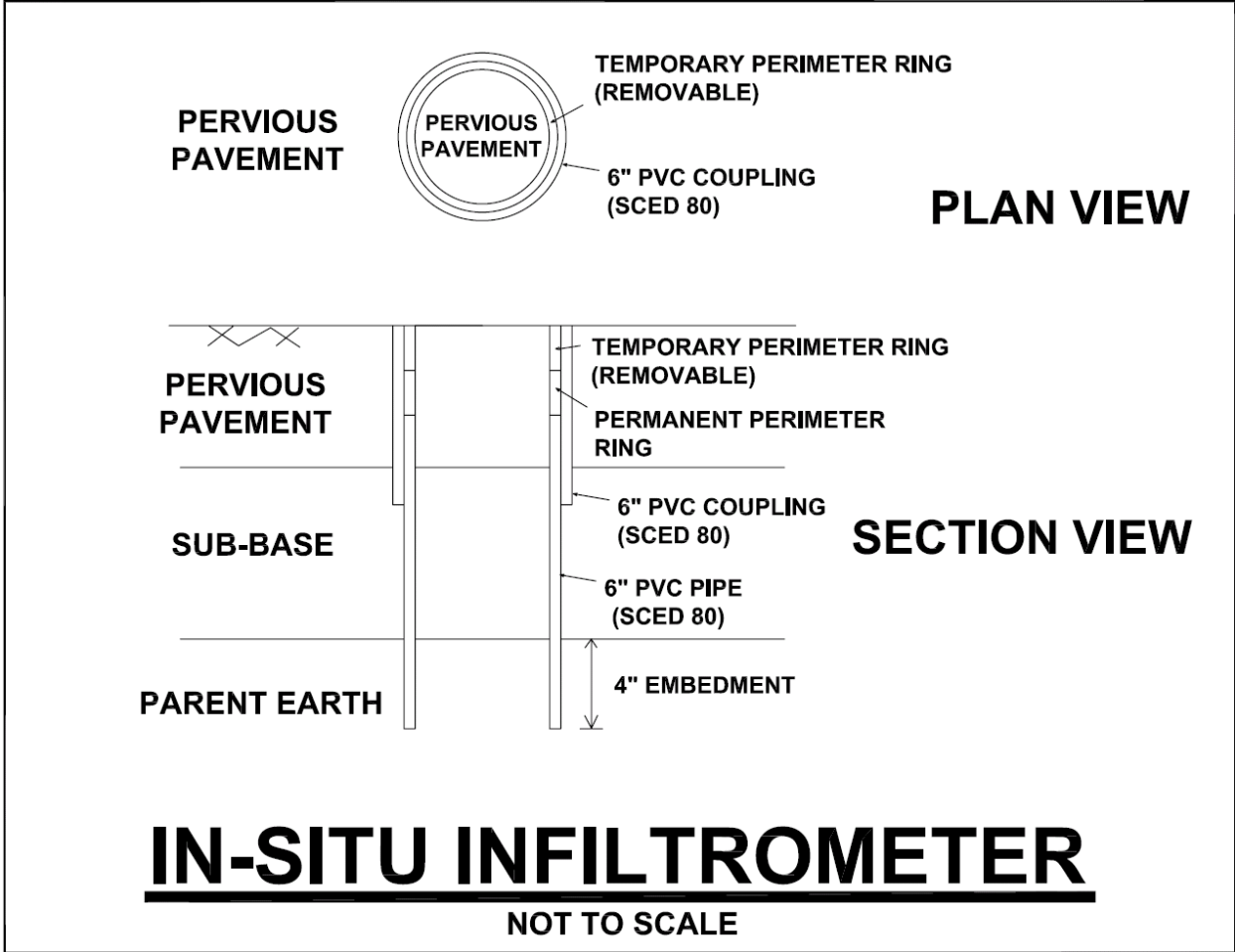

Figure 11.5 Plan View of ERIK In-Situ Infiltrometer  
(Embedded Ring Infiltration Kit)

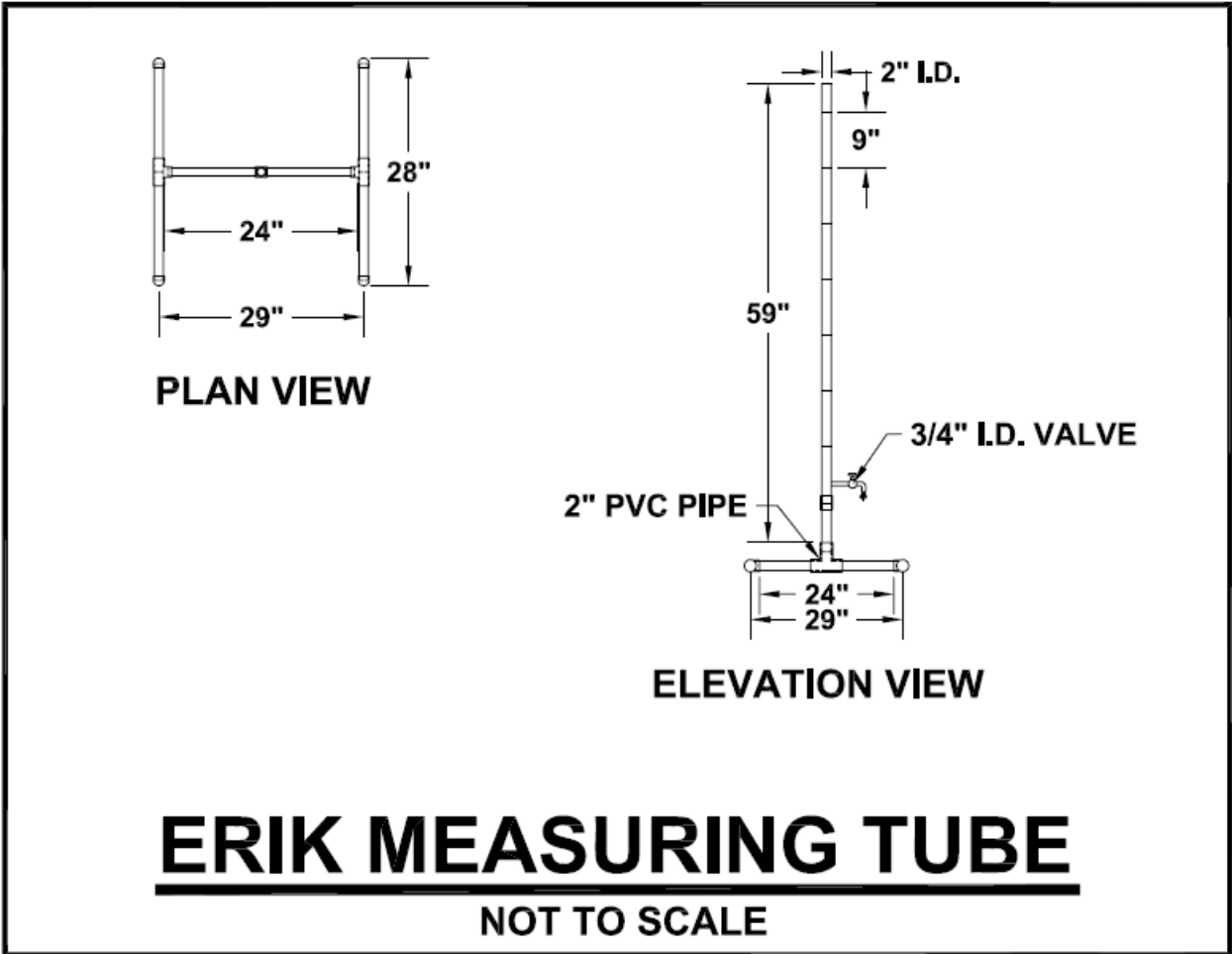

Figure 11.6 ERIK Measuring Tube

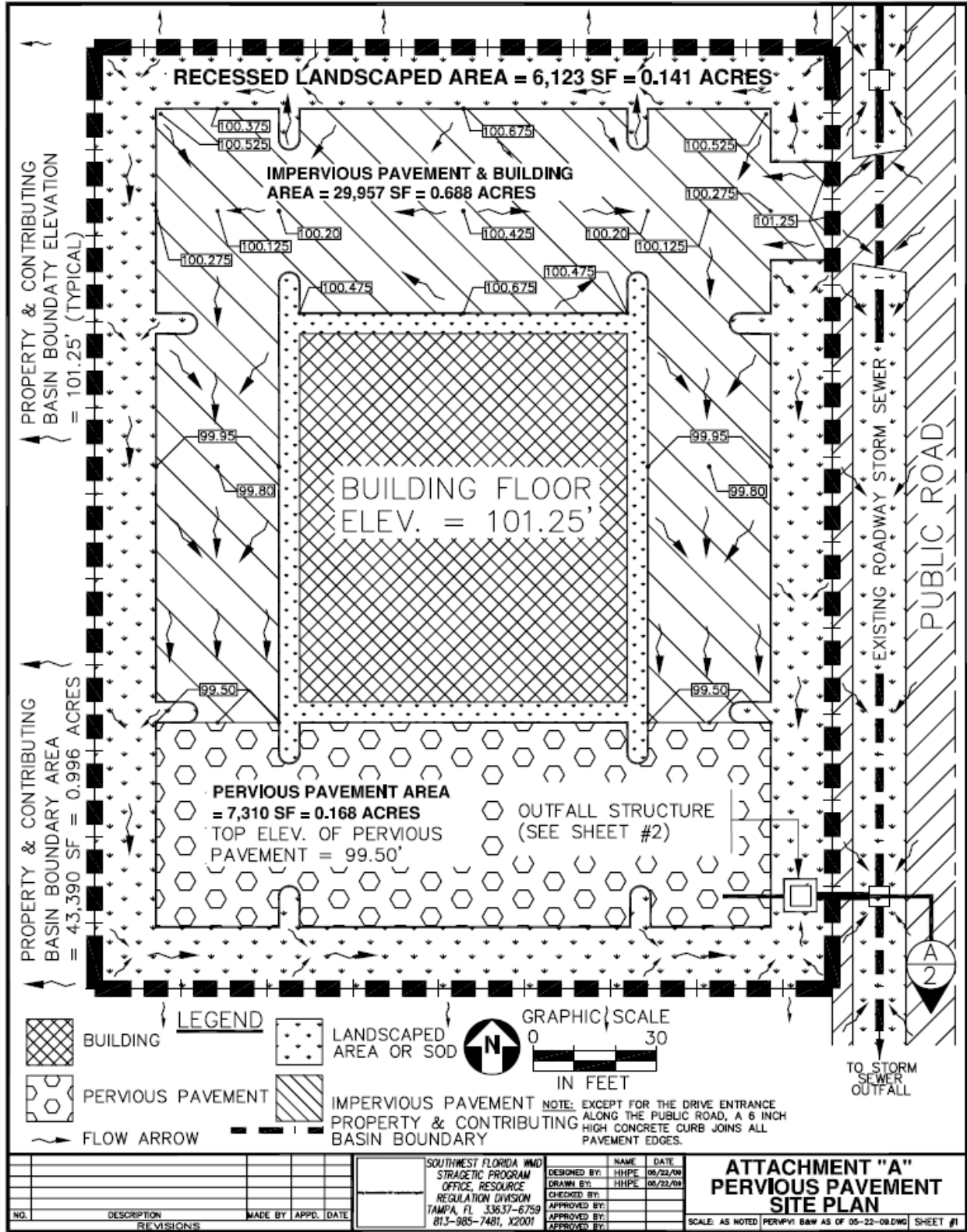

Figure 11.7 Pervious Pavement Site Plan

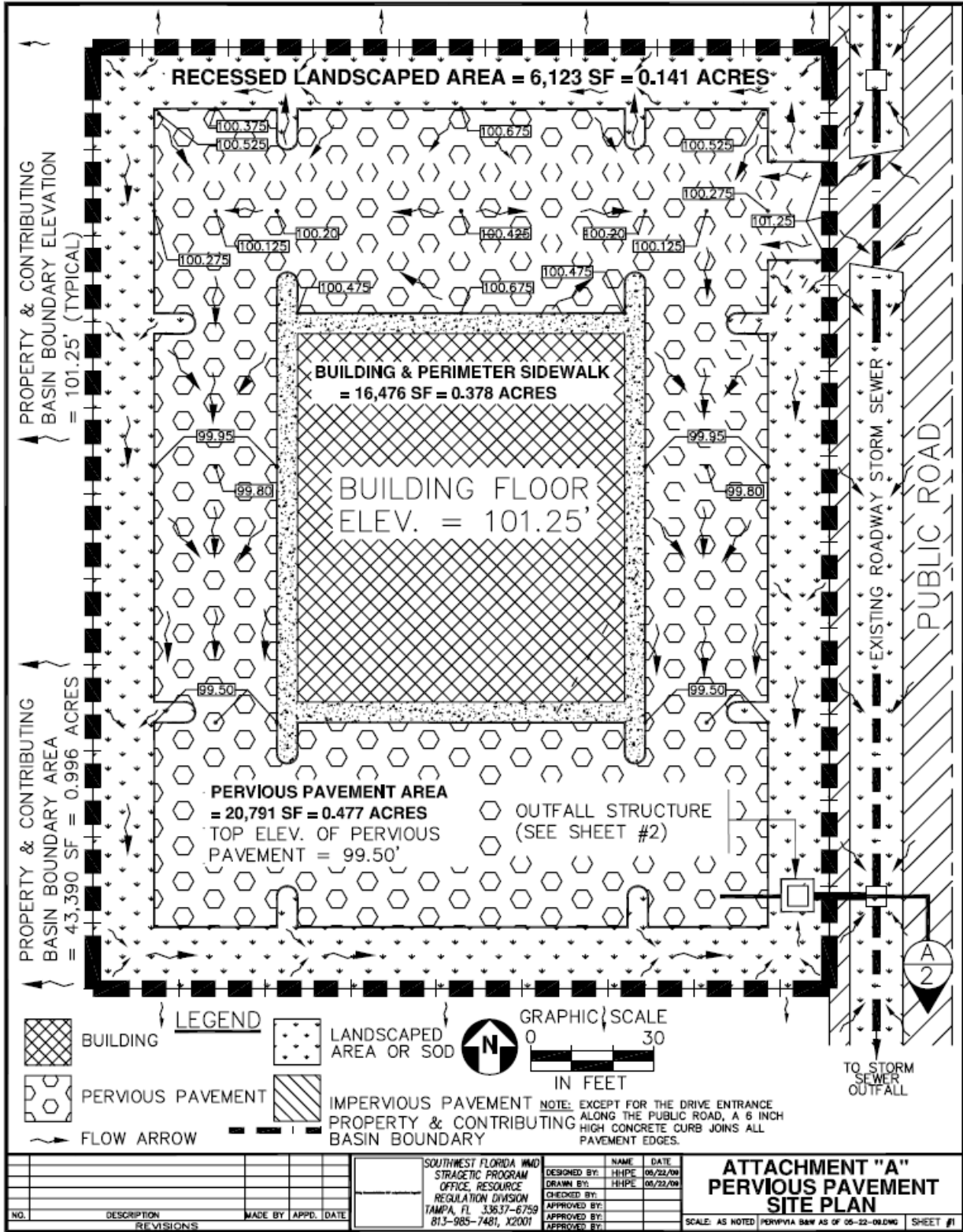

Figure 11.8 Pervious Pavement Site Plan

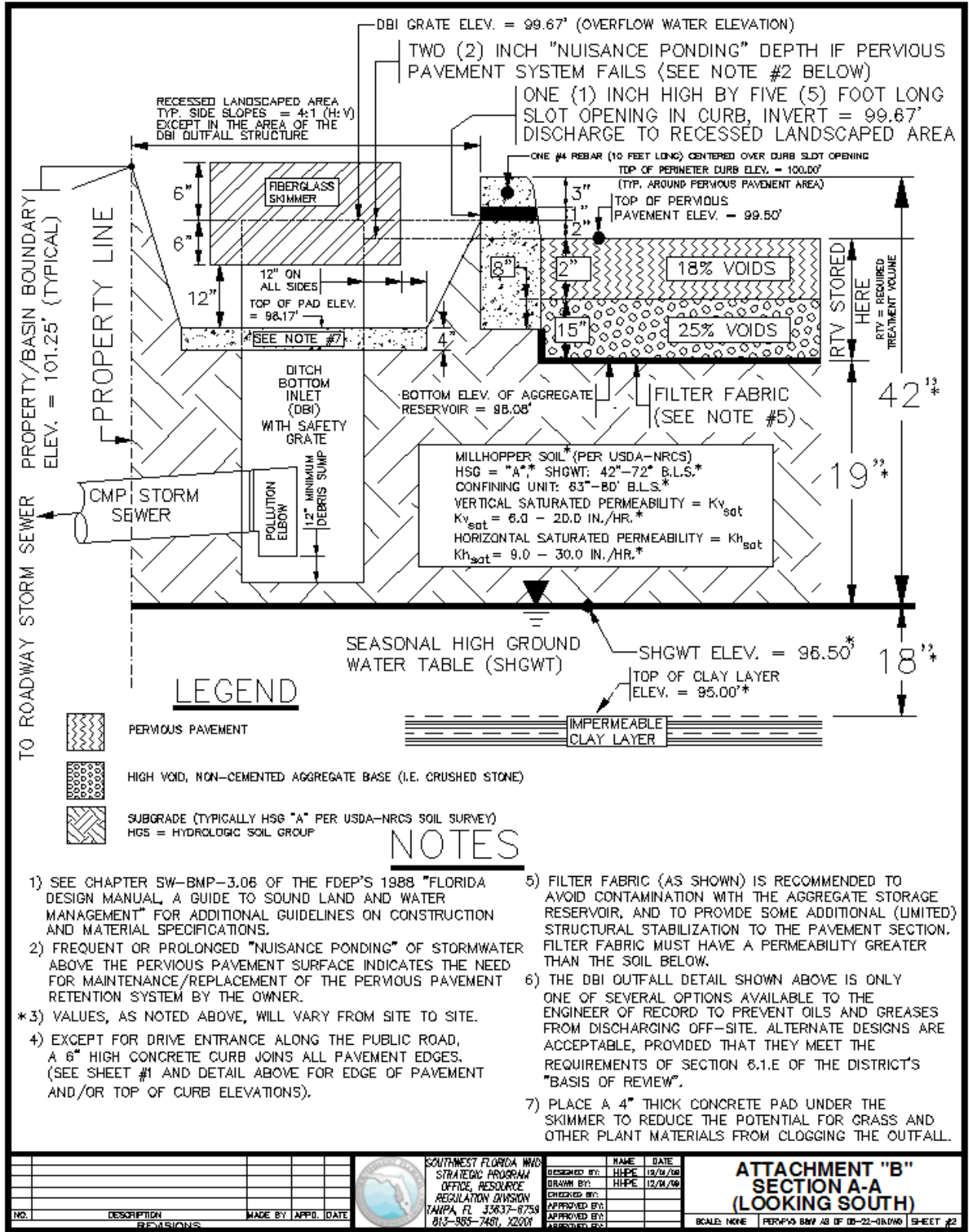

Figure 11.9 Pervious Pavement Site Plan



## 12.0 GREEN ROOF/CISTERN SYSTEM DESIGN CRITERIA

### 12.1 *Description*

A greenroof/cistern stormwater treatment system is a vegetated roof followed by storage in a cistern for the filtrate which is reused. A greenroof/cistern system is a retention BMP and its effectiveness is directly related to the annual volume of roof runoff that is captured, retained, and reused. The filtrate from the greenroof is collected in a cistern or, if the greenroof is part of a BMP Treatment Train, the filtrate may be discharged to a downstream BMP such as a wet detention pond. A cistern is sized for a specific amount of filtrate and receives no other runoff water. Other pond storage must also provide capacity to detain a specified quantity of filtrate. The detained water is used to irrigate the roof. Irrigation must be provided to maintain the plants. A back up source of water for irrigation is necessary. Excess filtrate and excess runoff can be discharged to other stormwater treatment systems, infiltrated into the ground, or used for irrigation or other nonpotable purposes. The greenroof/cistern system functions to attenuate, evaporate, and lower the volume of discharge and pollutant load coming from the roof surface. Greenroof systems have been shown to assist in stormwater management by attenuating hydrographs, neutralizing acid rain, reducing volume of discharge, and reducing the annual mass of pollutants discharged.

Concentrations of pollutants discharged from a greenroof with pollution control media have been shown to be approximately the same as would be anticipated from a conventional roof. Thus, the concentration and mass must be managed. If no pollution control media are used, greenroof concentrations are greater than those from conventional roofs. In addition, with fertilization of the plants, increased nutrients are expected and storage for the filtrate is required.

### 12.2 *Required Treatment Volume*

The treatment volume necessary to achieve the required treatment efficiency shall be captured by the greenroof/cistern system and used for irrigation of the greenroof plants or other landscaping. The required nutrient load reduction will be determined by the type of water body to which the stormwater system discharges and the associated performance standard as set forth in **Section 3.1** of this Handbook. Like all retention BMPs, the nutrient removal effectiveness is directly related to the annual volume of roof runoff that is retained and for greenroofs that is the volume within the greenroof/cistern system. However this treatment method has an additional irrigation input some of which returns to the cistern requiring the cistern to be larger than that required by retention without irrigation return. Nevertheless, the method can be used for nutrient load reduction. Treatment volumes to achieve the required nutrient load reduction shall be determined based on the percentage of directly connected impervious area (DCIA) and the weighted curve number for non-DCIA as shown in **Appendix E**. Design examples and calculations are shown in **Section 23** of this Handbook.

### 12.3 *Classification of Greenroof Surfaces*

There are two types of greenroofs described in this Handbook. An **extensive greenroof** is one where the root zone (pollution control layer and growth media layer) is less than 6 inches in depth. Whereas **intensive greenroofs** have root zones greater than or equal to 6 inches and are typically intended for public or private access. There are two distinct functions for green roofs, one is passive and the other is active. Passive greenroofs are intended only for maintenance access and typically require less maintenance, while an active roof is used for public and private access. Greenroofs can be built on any type of roof deck with a minimum slope of one inch per foot. There are several components that are required for greenroofs as described in the following sections of this Handbook.



**Figures 12.1a and 12.1b** provide typical greenroof details for the different types of roofs and various component details.

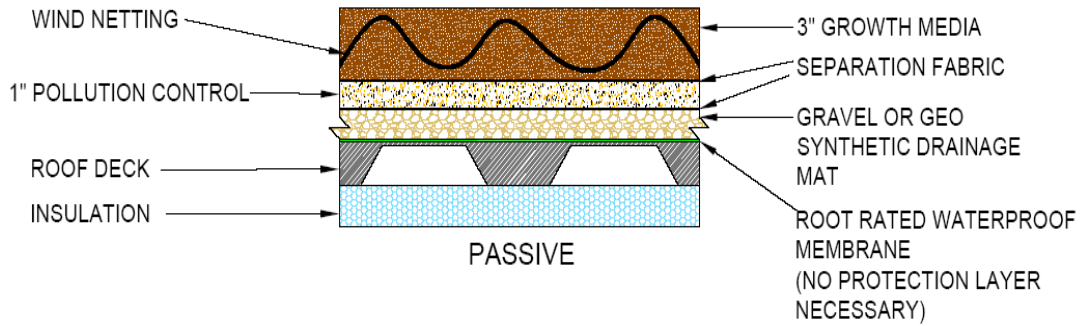

**Figure 12.1a Extensive Greenroof Section (Usually Passive Function)**

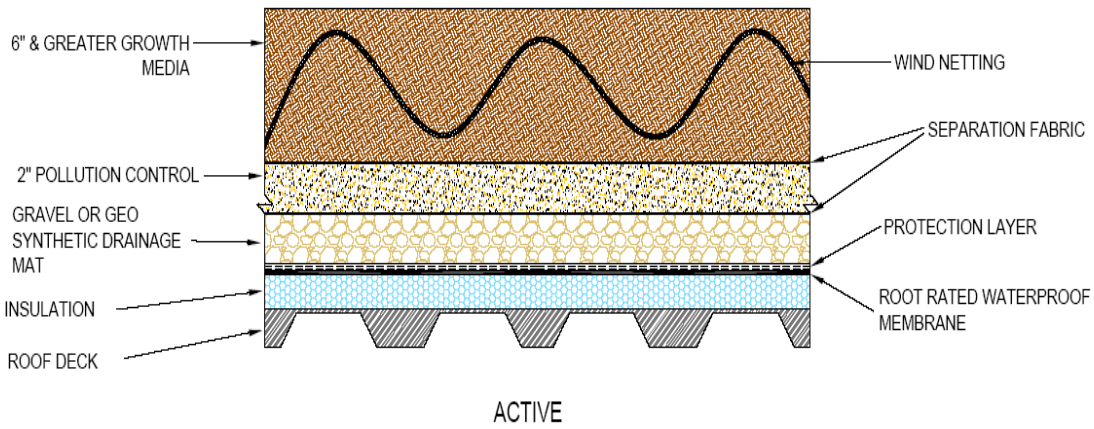

**Figure 12.1b Intensive Greenroof Section (Usually Active Function)**

## 12.4 Design Criteria

- (a) Greenroof/cistern systems shall be designed to capture and use the required treatment volume for irrigation without discharge except to downstream BMPs if used as part of a BMP treatment train.
- (b) **Waterproof Membrane** - A waterproof membrane layer must be incorporated into the roof system to protect the structure from moisture damage. There are several options for this layer such as, polypropylene or polyethylene membrane, polyvinyl chloride, or spray applied elastomeric waterproofing membrane as well as others. The applicant must check with the membrane manufacturer to ensure that the membrane is rated as a root protection material. All permitted design specifications and manufacturer's installation directions shall be followed to ensure that the proposed product will function as intended with greenroof overburden.
- (d) **Drainage Layer** - The major function of the drainage layer is to facilitate lateral movement of the filtrate to the point of drainage to ensure no standing water is present. The drainage layer can consist of several different materials such as gravel, recycled products, or geo-synthetic drainage mats. It is important to note that whatever material used shall not depress or elevate the pH of the filtrate more than 1.5 pH units from neutral. When using aggregate as drainage layer materials, it must contain no more than 7% "fines" (particles passing sieve number 200) by mass. The drainage material must be able to structurally support the intended greenroof overburden, as well as maintenance activities, without deflection such that drainage is blocked or restricted. A non-woven geotextile separation fabric must be installed on top of the drainage layer to prevent clogging of the drainage layer. This fabric shall have a thickness to pass the drainage water and void spaces such that the pollution control media does not fill the surface void area of the drainage layer and cause clogging. The hydraulic conductivity of the fabric must exceed 1.5 inches per hour.
- (e) **Pollution Control Media** - Greenroofs used for stormwater treatment credit must use a pollution control media layer. The pollution control layer is at least 1 inch in depth. This layer is to include materials known to adsorb pollutants such as phosphorus, nitrogen, metals or other pollutants of concern for the installation site. Pollution control media shall meet all of the following specifications.
- All soil media mixes must display no acute toxicity at the applied media mix.
  - Unit Weight is no more than 45 pounds per cubic foot when dry.
  - No more than 5% of the particles passing the #200 sieve.
  - Over 50% mineral by volume and contains no shale.
  - At least 1 inch in thickness.
  - Water holding capacity is at least 30%, and as measured by porosity.
  - Permeability is at least 1.5 inches per hour. Permeability is vertical hydraulic conductivity at the specified unit weight noted above.
  - Organic content is no more than 10% by volume.
  - pH is between 6.5 and 8.0.
  - Soluble salts are less than 3.5 g (KCL)/L.
  - Sorption capacity exceeds 0.005 mg OP/mg media.
- (f) **Growth Media** - The growth media is intended to be the main support coarse for the vegetation. The growth media is installed on top of the separation fabric. Growth media shall meet all of the following specifications.

- Unit Weight is no more than 45 pounds per cubic foot when dry.
- No more than 10% of the particles passing the #200 sieve.
- Contains no shale.
- At least 3 inches in thickness.
- Water holding capacity is at least 30%, and as measured by porosity.
- Permeability is at least 1.5 inches per hour. Permeability is vertical hydraulic conductivity at the specified unit weight noted above.
- Organic content is no more than 10% by volume.
- pH is between 6.5 and 8.0.
- Soluble salts are less than 3.5 g (KCL)/L.

(g) **Preventing wind uplift** – To assure that a greenroof built in Florida remains operable, the greenroof must be designed to prevent wind uplift. A three dimensional netting made of polyamide (nylon) filaments connected together woven into the growth media layer or other equivalent method is acceptable. As an alternative, a parapet of sufficient height can be used. For buildings less than 100 feet tall, a parapet height of 36 inches can be used in place of wind netting.

(h) **Vegetation** – Florida native vegetation is recommended on greenroofs used for stormwater treatment. Low maintenance plants and drought tolerant plants are recommended but not mandatory because of the use of stored stormwater for irrigation. However, plants tolerant to high levels of direct sunlight and high temperatures are necessary for the success of a healthy greenroof plants. Care should be made to ensure that the available root zone of the greenroof is sufficient for the intended plants. When designing an intensive greenroof, larger plants with more rigorous maintenance schedules are acceptable. Plants must achieve at least 80% cover of the greenroof area within one year of planting. When the vegetation density is less than 80%, new plants shall be added. **Table 12.1** includes plants that have been successfully used on greenroofs in the different parts of Florida. Other plants are acceptable and applicants are encouraged to consult landscape architects and native nursery personnel for appropriate plants.

Note for plants used on greenroofs in coastal areas, salt tolerance is an important consideration. Some examples of plants used along the coast are Simpson stopper, Snake plant, Muhly grass, Inkberry, and Beach sunflower.

PLANT	NORTH FL	CENTRAL FL	SOUTH FL
Muhly grass	X	X	X
Butterfly Weed		X	X
Blanket Flower	X	X	X
Sunshine mimosa		X	X
Perennial peanut	X	X	X
Snake weed		X	X
Asiatic Jasmine	X	X	X
Simpson Stopper		X	
Black Eyed Susan	X	X	
Beach Sunflower	X	X	X

**Table 12-1 Plants that have been successfully used on greenroofs in Florida**

(i) **Irrigation** - Irrigation is required on all greenroofs in Florida to assure plant survival and to recover the required treatment volume. Drip irrigation applied at the growth media surface is required, usually with one foot on-center spacing. Irrigation pumps must be installed with an

alarm system to signal any mechanical problems. Irrigation will vary by season and a rain shut-off sensor is required. Flow meters shall be installed as a means of documenting when irrigation occurs and the volume of water used for irrigation. The addition of make-up water will be required during parts of the year depending on local rainfall patterns and records must be kept to document how much make-up water is added. The recommended source of make-up water is stormwater or gray water, whenever available. An in-line filter is recommended to reduce the maintenance problems and cost of irrigation line replacement. Depending upon the greenroof retention volume and design, irrigation shall occur three to four times per week with a maximum total application of one (1.0) inch per week if filtrate or stormwater are available.

- (j) **Roof Drain** - The greenroof must drain into a storage device, typically a cistern. The slope of the roof must be at least ¼ inch per foot. The primary drain can be an interior drain or gutter drain. A one foot barrier must be maintained around the drain to prevent vegetation and debris from clogging drain as well as providing easy inspection. This barrier can be an aluminum break or a washed river stone section. An overflow shall also be provided to ensure drainage in the event that a clog occurs in the primary drain.
- (k) **Cistern or Other Water Storage Area** - The cistern or other water storage area serves to store filtrate for use as irrigation. Filtrate volumes in excess of those required for irrigating the greenroof can be used to either irrigate ground level landscaping or can be directed to other retention BMPs that allow for infiltration. If there is a discharge to a wet detention system, then the green roof efficiency must be calculated using the BMP Treatment Train equations. Cistern or other storage placement can be below ground or above ground. If an above ground cistern is used it must be UV stable, dark in color, and must be placed in areas of low to no direct sunlight. Direct sunlight may cause irrigation water temperature to get too hot for plants.

## 12.5 *Design Criteria for Management of the Filtrate*

There are two common designs for management of the filtrate. The first design is to collect filtrate from a greenroof in a cistern. The cistern has no other water inputs except for supplemental makeup water. It is also not open to the atmosphere. Water in the cistern is used to irrigate the greenroof, or other nearby landscaping, or can be used for other nonpotable purposes. Cistern annual volume reduction equations and graphs as a function of cistern storage were developed and are used to estimate retention as a function of the storage volume. For this design management of filtrate, the yearly mass reduction is equal to the yearly volume reduction. Cistern design curves are provided in **Section 12.9** of this Handbook for greenroofs and for irrigation rates commonly used in Florida. The design curves provide the amount of cistern storage required for a specified annual retention of rainfall or reduction in discharge from the greenroof and cistern system.

The second design condition is when the greenroof filtrate is discharged from the roof into a conveyance system or into another BMP such as a wet detention pond. For this case, the removal of the nutrient is proportional to the removal effectiveness of the pond. However, note that the flow to the pond without a cistern is reduced by 33-51% depending on location (see **Section 12.9** for estimates for 18 locations around the State and read as the % yearly retention when no cistern is used). For example, in Miami, the average annual retention of a greenroof without a cistern is 42% (as read from the cistern design curves in **Section 12.9**). For each station, the percent retention with no cistern is given at the bottom of the figures.

## 12.6 Construction requirements

To assure proper construction of the greenroof/cistern stormwater harvesting system the following construction procedures are required:

- (a) Construct the greenroof in accordance with permitted design plans and specifications.
- (b) Be sure that all greenroof waterproofing components are properly installed before placing any of the media on the greenroof.
- (c) Be sure all equipment and plants are properly sited per design drawings and installed properly.
- (d) Construct the irrigation system in accordance with all permitted design specifications and irrigation system design standards.
- (e) Assure that all irrigation components are properly sited and that irrigation spray heads are working properly and not spraying irrigation water onto impervious areas.

## 12.7 Inspections, Operation and Maintenance

Maintenance issues associated with greenroof/cistern systems are related to the health of the plants, the drainage capabilities of the system, and proper functioning of the irrigation system.

Greenroof/cistern systems must be inspected annually by the operation and maintenance entity to determine if it is operating as designed and permitted. **Reports documenting the results of annual inspections shall be filed with the Agency every three years.**

### (a) Inspection Items:

- (1) Inspect operation of the greenroof/cistern system to assure that rainfall is flowing properly through the greenroof and into the cistern.
- (2) Inspect the plants on the greenroof to assure they are healthy and growing. Assure plants are covering at least 80% of the surface area of the greenroof and that plant species not on the approved plant list are not becoming established.
- (3) If an intensive greenroof, inspect it for damage by foot traffic or other human uses of the greenroof.
- (4) Inspect the operation of the pumping system and the irrigation system to assure they are working properly.

### (b) Maintenance Activities As-Needed To Prolong Service:

- (1) Repair any components of the greenroof drainage system which are not functioning properly and restore proper flow of stormwater or filtrate.
- (2) Maintain the plants on the greenroof on an as needed basis to assure healthy growth and meet the required 80% coverage of the greenroof. Weeding to remove plants not on the approve design plant list will be needed on a regular basis. Whenever plant coverage is less than 80%, new plants shall be established as soon as possible.
- (3) Repair any damage to the greenroof by foot traffic or other human uses.

- (4) Repair or replace any damaged components of the pumping and irrigation system as needed for proper operation.

(c) Record keeping

The owner/operator of a greenroof/cistern system must keep a maintenance log of activities which is available at any time for inspection or recertification purposes. The log will include records related to the use of the filtrate water for irrigation to demonstrate that the permitted nutrient load reduction is being achieved. A flow meter to measure the quantity and day/time of irrigation is required. Visual observations of the success of plant growth and cover, including photo documentation is also required. The maintenance log shall include the following:

- (1) Irrigation volume measured using a flow meter specifying the day and amount;
- (2) Cistern overflow volumes and makeup water volumes;
- (3) Observations of the irrigation system operation, maintenance, and a list of parts that were replaced;
- (4) Pruning and weeding times and dates to maintain plant health and 80% coverage;
- (5) A list of dead, dying, or damaged plants that are removed and replaced;
- (6) Maintenance of roof mechanical equipment;
- (7) Dates on which the greenroof was inspected and maintenance activities conducted; and
- (8) Dates on which fertilizer, pesticide, or compost was added and the amounts used.

### **12.8 Greenroof Cistern/Harvesting Design Curves and Equations**

A cistern is used with a greenroof to store the water and then the stored water is reused on the greenroof for irrigation. By doing this, the direct discharge to surface water is reduced. Wanielista and Hardin (2006) showed that a cistern designed to collect 5 inches of rainfall from a greenroof with pollution control media composed of a blend of tire crumb, was able to remove at least 90% of the mass of Soluble Reactive Phosphorus (SRP) and 98% of the mass of Nitrate Nitrogen. These removals were measured over one year and depend on the rainfall conditions in that year. The size of the cistern is dependent on local rainfall conditions and the rate of water used from the cistern.

The greenroof and cistern functions to attenuate, evaporate, and lower the volume of discharge coming from a roof surface. The greenroof system will also neutralize acid rain, reduce mass of pollutants, and attenuate hydrographs. The storage discharge design of the cistern determines the attenuation. A greenroof with cistern will achieve higher efficiencies (greater than 70%) than if used without a cistern (~ 40%). When used with a cistern, the cistern discharge will have less pollutant mass than discharge without a cistern. Design graphs have been developed for many locations in the State (Hardin, 2006 and Hardin and Wanielista, 2007).

In the order of how they follow, the 18 locations for which greenroof/cistern harvesting design curves and equations have been developed include:

1. Belle Glade
2. Boca Raton
3. Brooksville
4. Daytona Beach
5. Fort Myers
6. Gainesville
7. Homestead
10. Lakeland
11. Miami
12. Niceville
13. Orlando
14. Panama City
15. Tallahassee
16. Tampa

- 8. Jacksonville
- 9. Key West
- 17. Venice
- 18. West Palm Beach

The design curves and equations are based on cistern storage values of between one-half inch (0.5”) and five inches (5.0”). The upper storage limit of five inches was set because there is marginal improvement in pollutant removal above five inches. For example, in Belle Glade, the yearly retention of a greenroof/cistern system is:

$$\begin{aligned} \% \text{ RETENTION} &= 10.70 \ln(S)+72.36. \text{ If cistern storage is 2”}, \text{ this becomes:} \\ \% \text{ RETENTION} &= 10.70 \ln(2)+72.36 = (10.70*0.69315) + 72.36 = 7.42 + 72.36 = 79.78\% \end{aligned}$$

This is considerable larger than the 50% retention by the greenroof alone.

## Greenroof Harvesting Design Curve for Belle Glade Florida Area Using 48 years of data

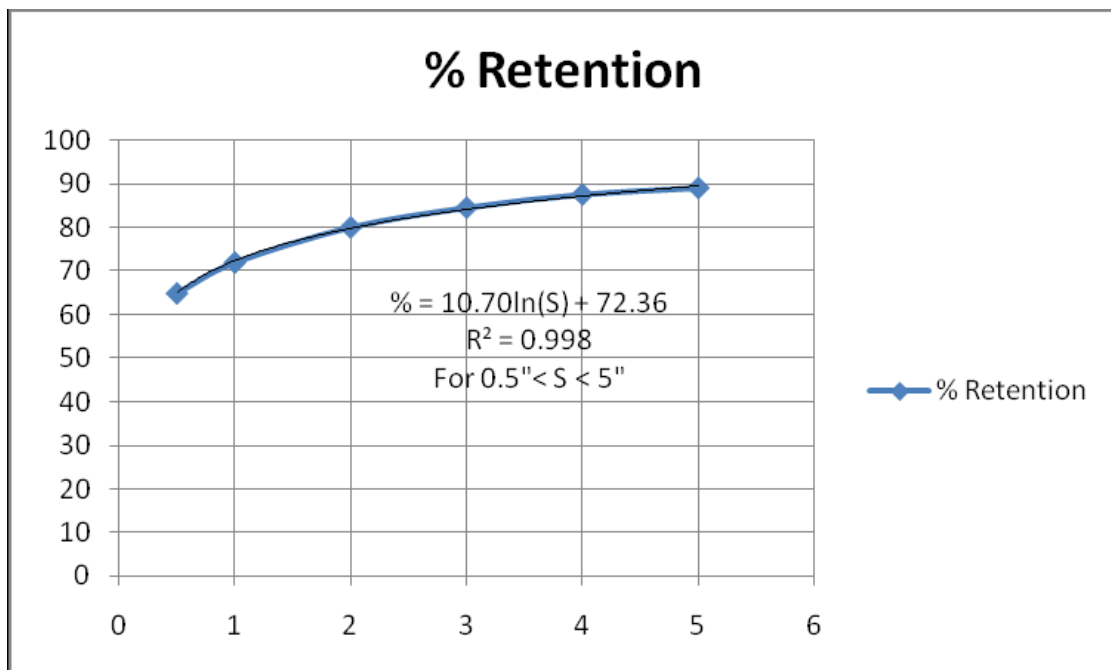
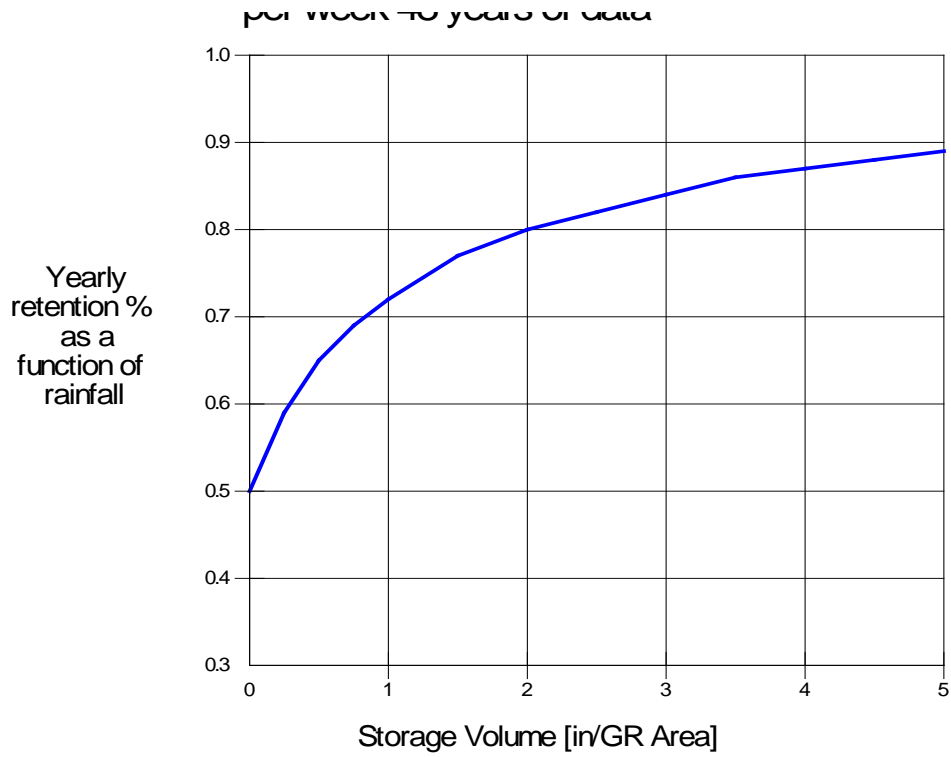

At Belle Glade, percent yearly retention by a greenroof with no cistern is 50%.



## Greenroof Harvesting Design Curve for Boca Raton Florida Area Using 62 years of data

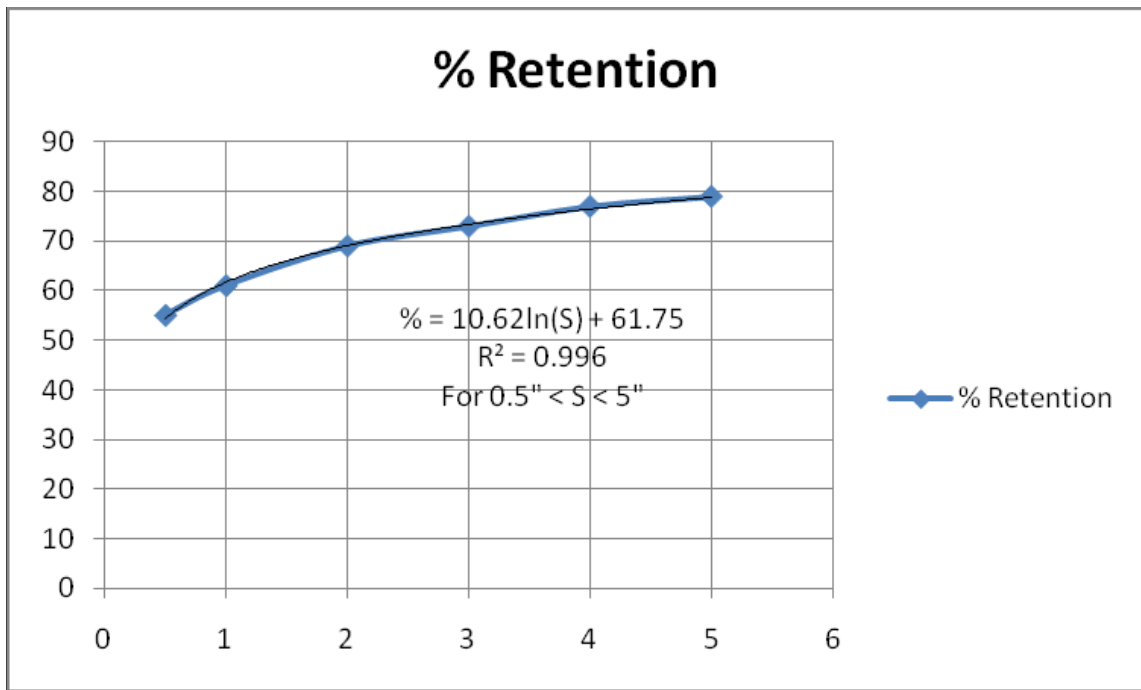
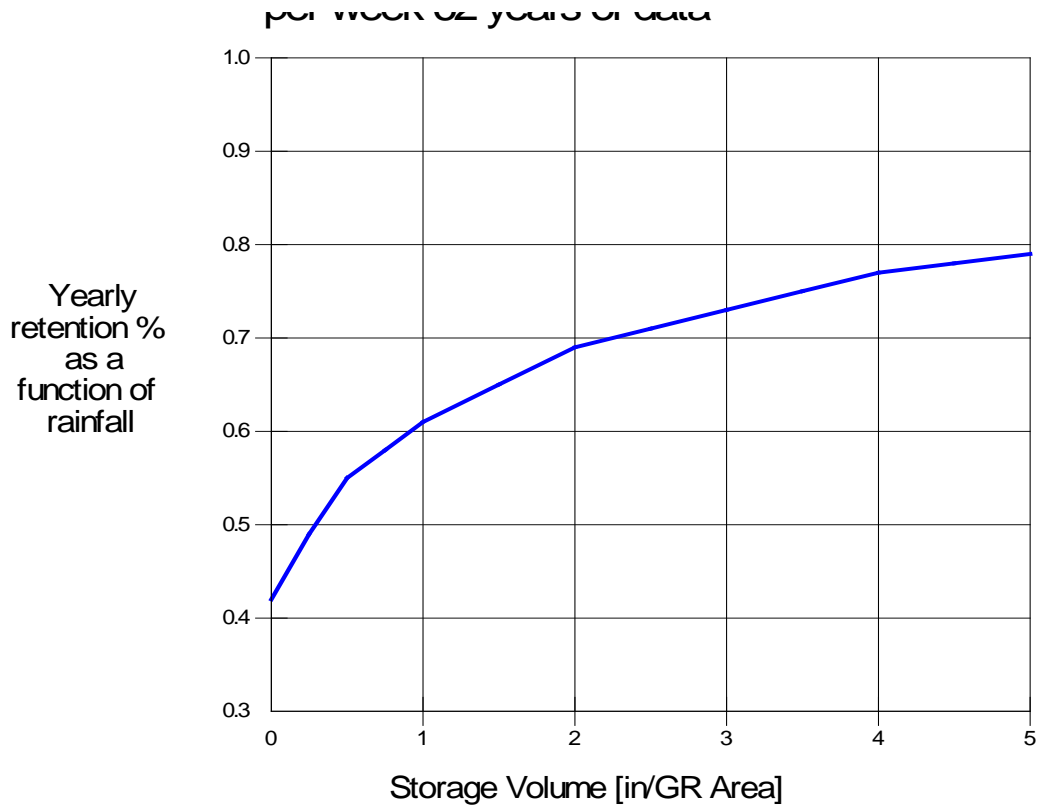

At Boca Raton, percent yearly retention by a greenroof with no cistern is 42%.

## Greenroof Harvesting Design Curve for Brooksville Florida Area Using 31 years of data

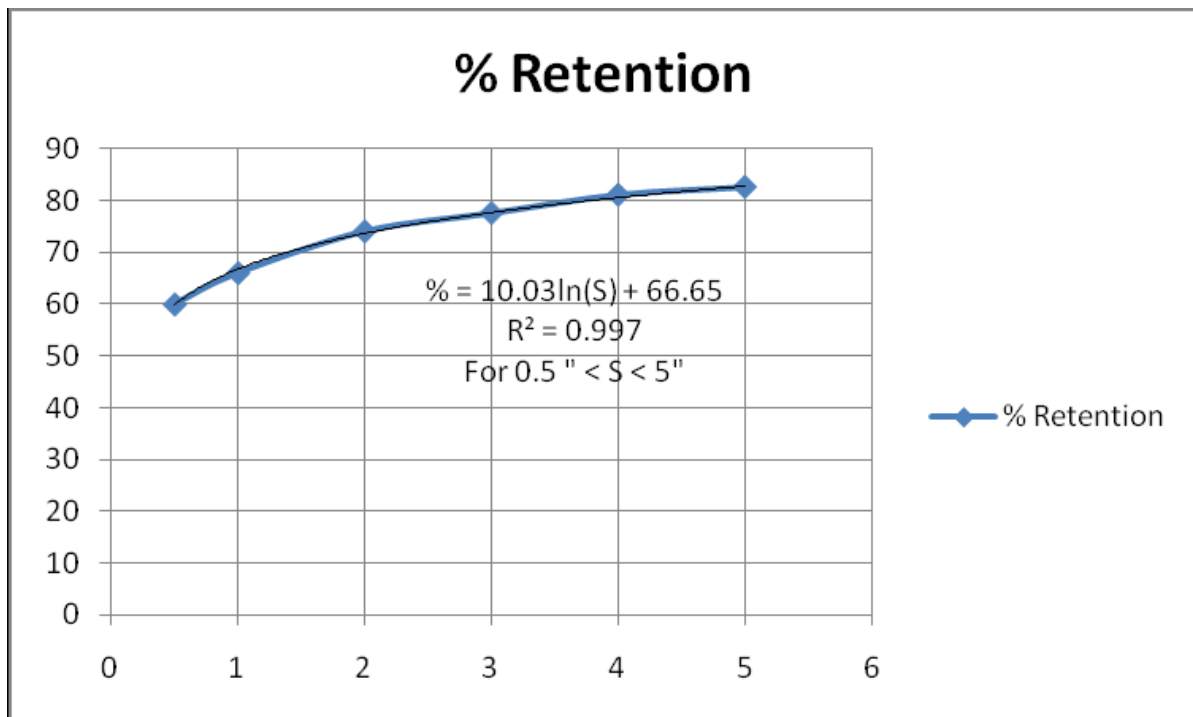
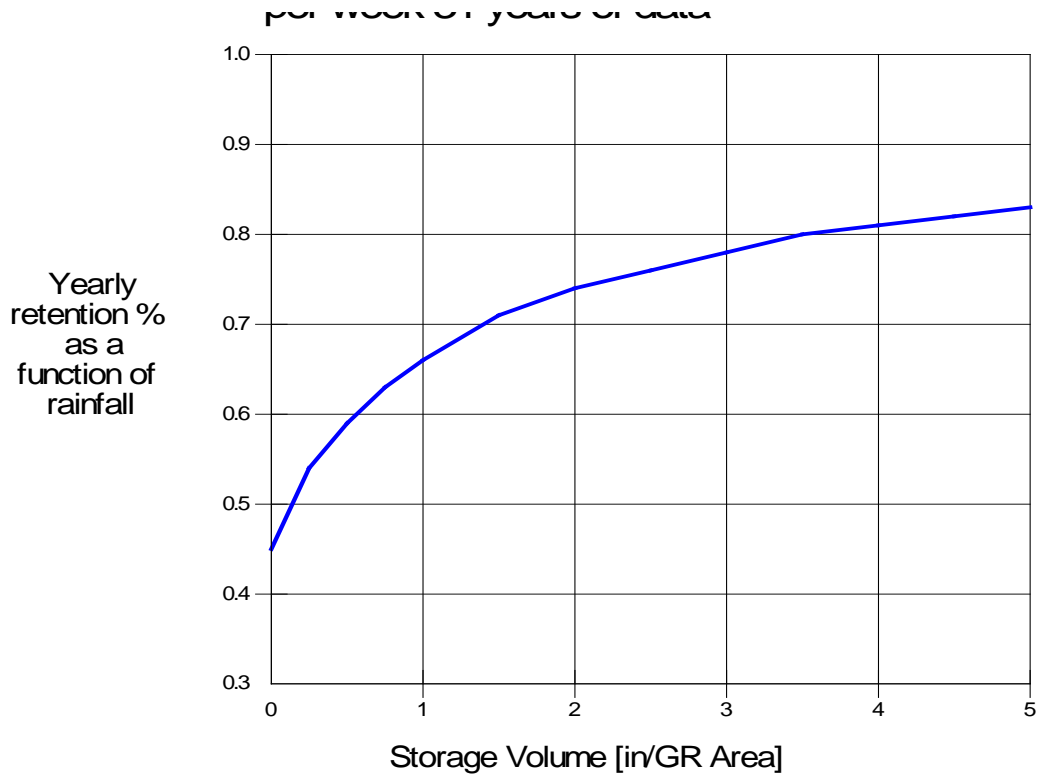

At Brooksville, percent yearly retention by a greenroof with no cistern is 45%.

## Greenroof Harvesting Design Curve for Daytona Beach Florida Area Using 63 years of data

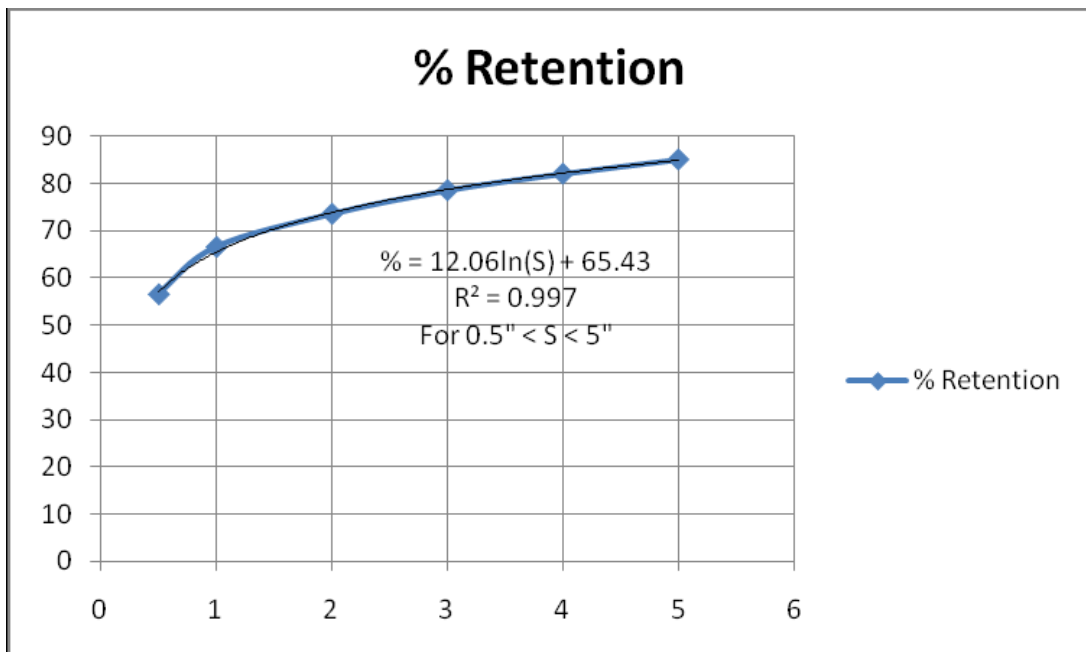
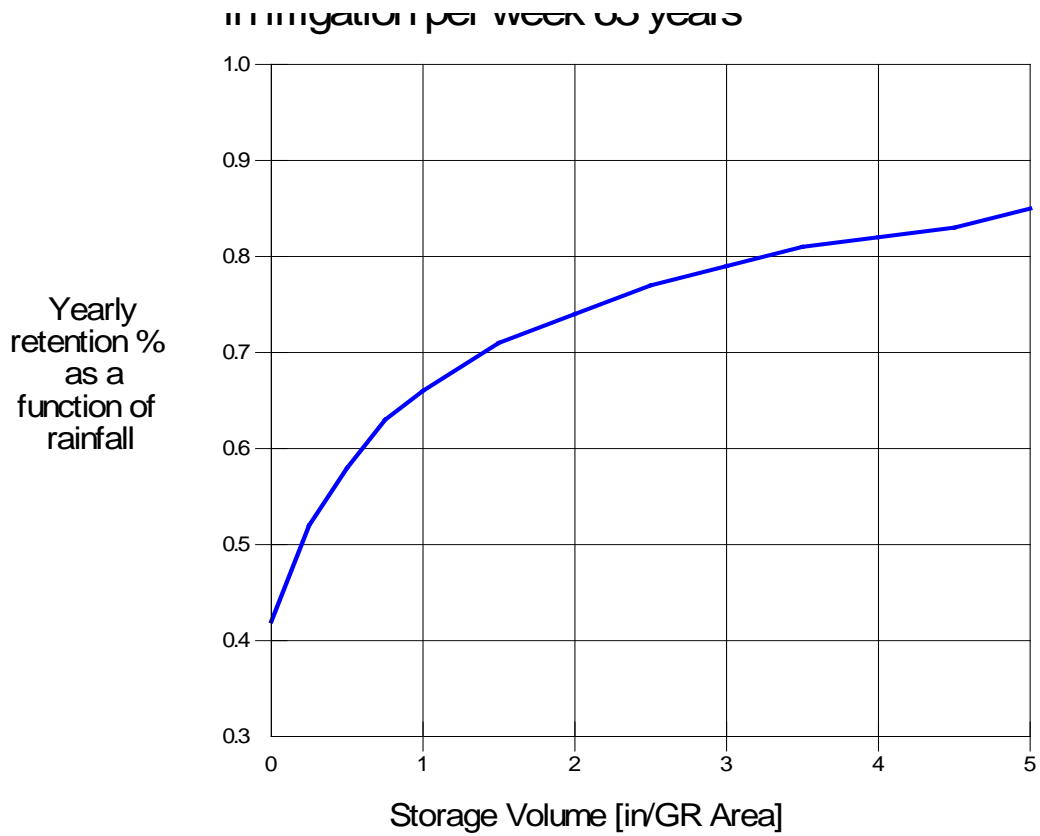

At Daytona Beach, percent yearly retention by a greenroof with no cistern is 42%.

## Greenroof Harvesting Design Curve for Fort Myers Florida Area Using 38 years of data

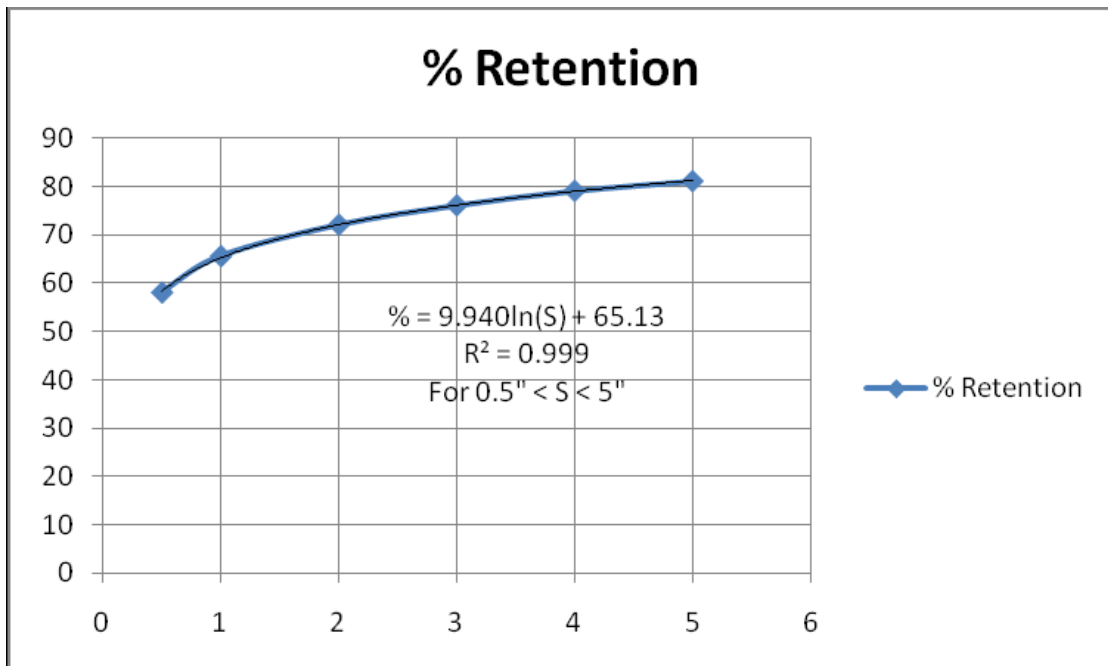
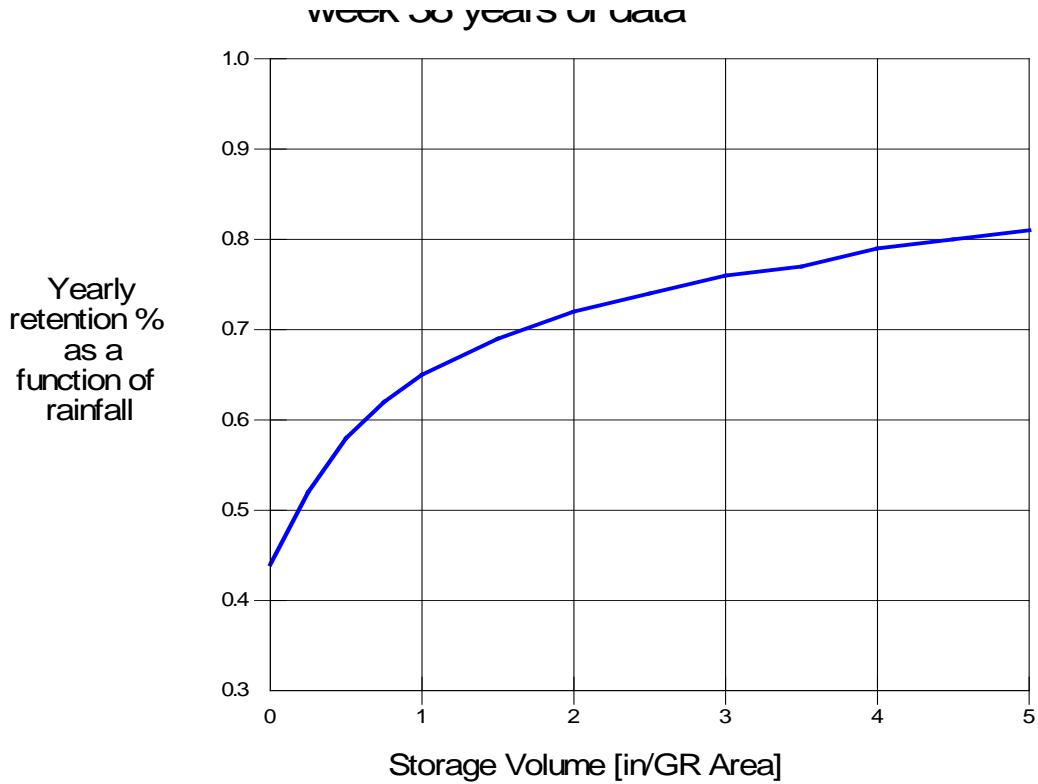

At Fort Myers, percent yearly retention by a greenroof with no cistern is 44%.

## Greenroof Harvesting Design Curve for Gainesville Florida Area Using 32 years of data

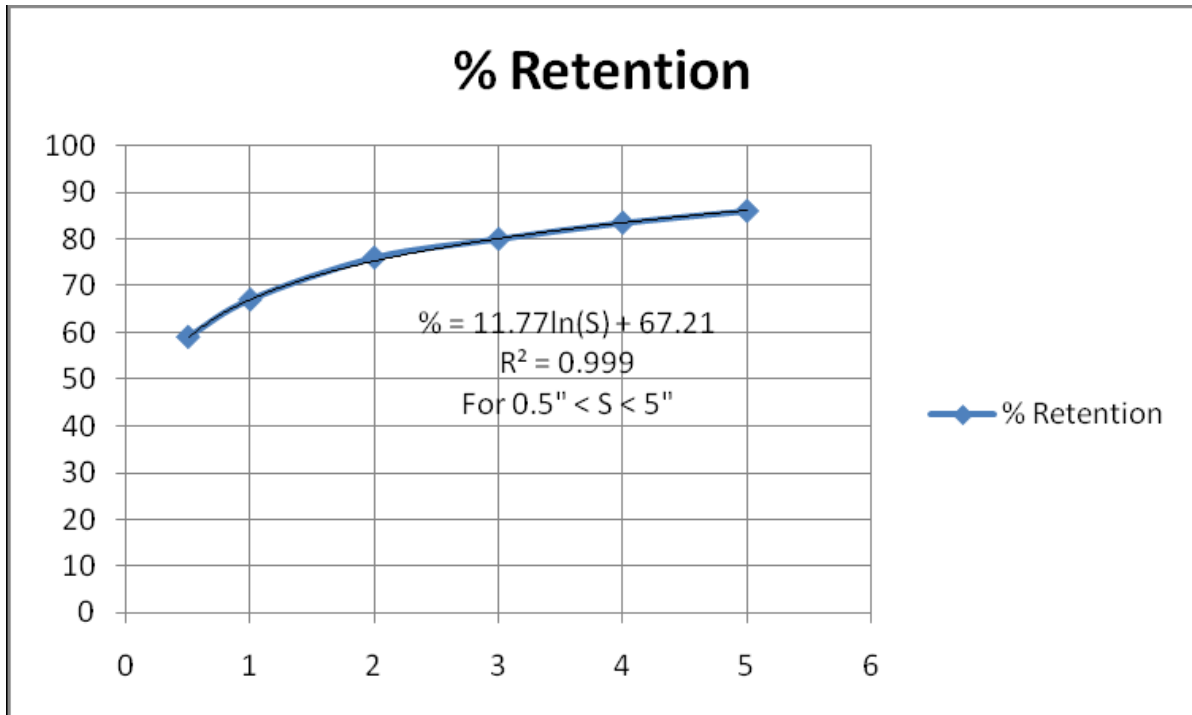
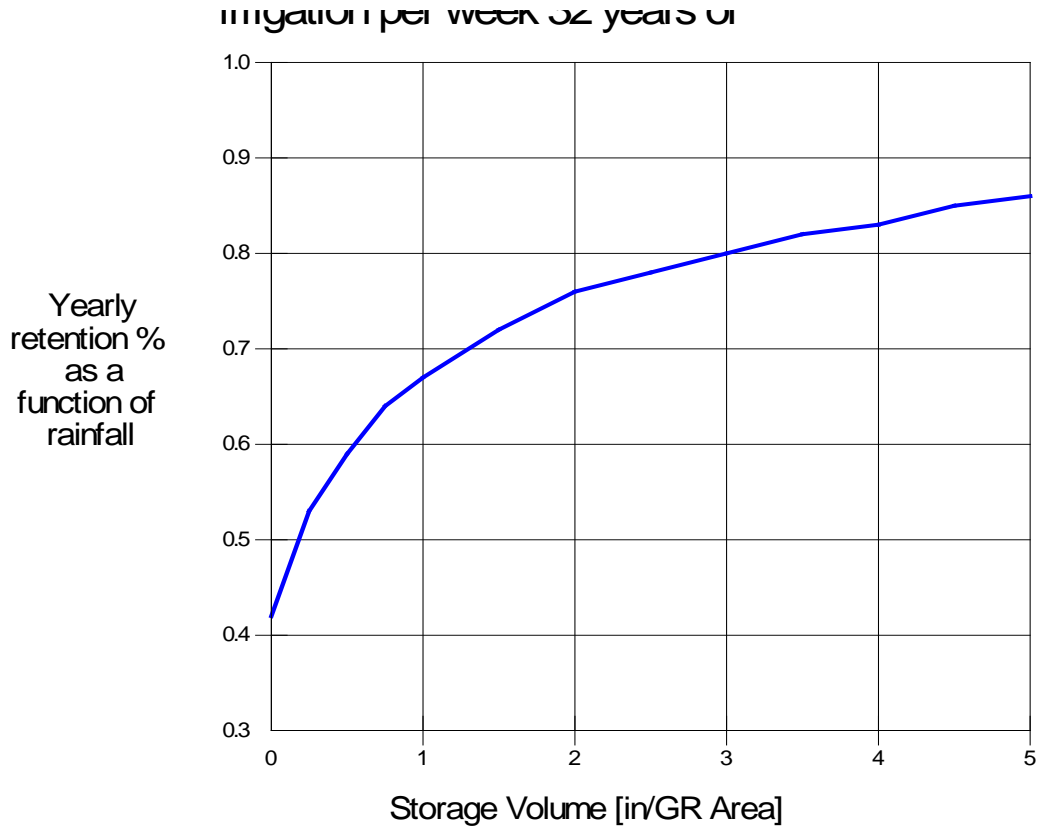

At Gainesville, percent yearly retention by a greenroof with no cistern is 42%.

## Greenroof Harvesting Design Curve for Homestead Florida Area Using 20 years of data

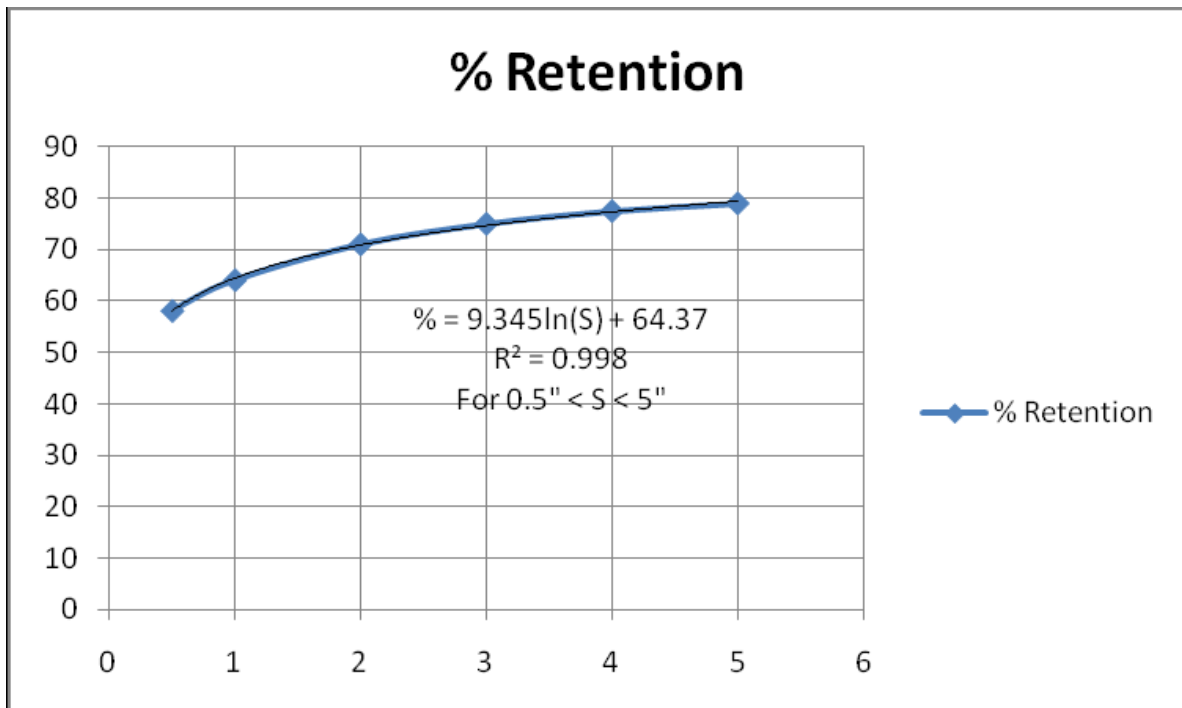
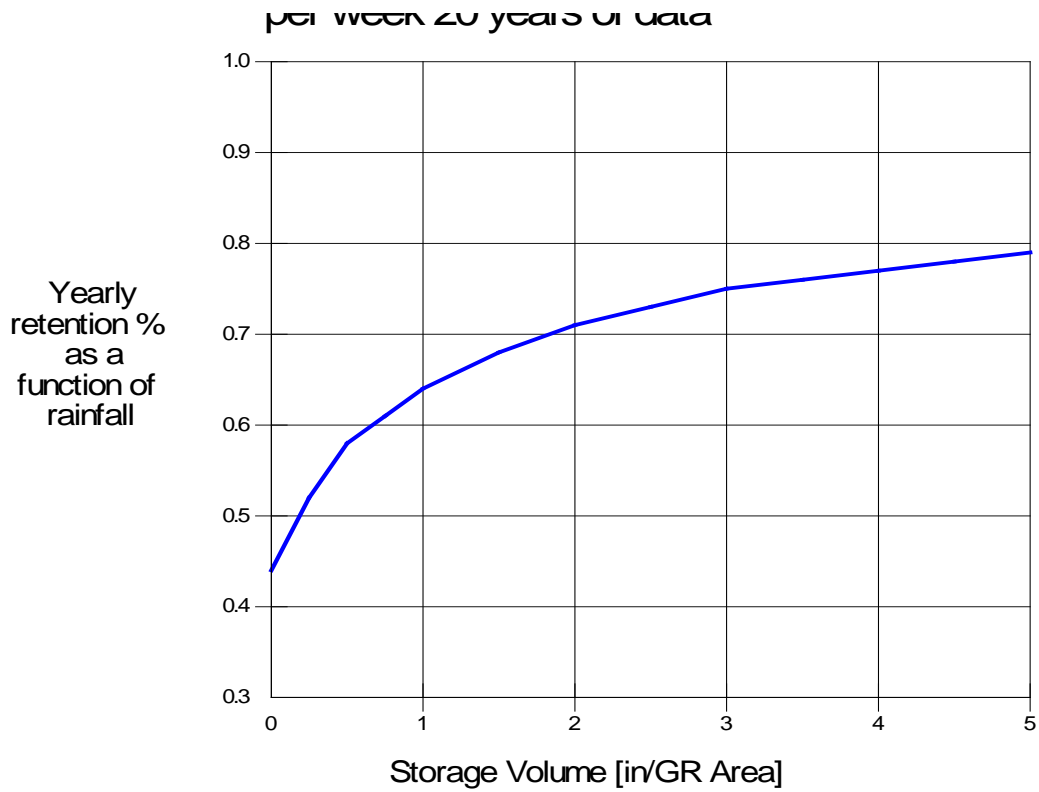

At Homestead, percent yearly retention by a greenroof with no cistern is 44%.

## Greenroof Harvesting Design Curve for Jacksonville Florida Area Using 57 years of data

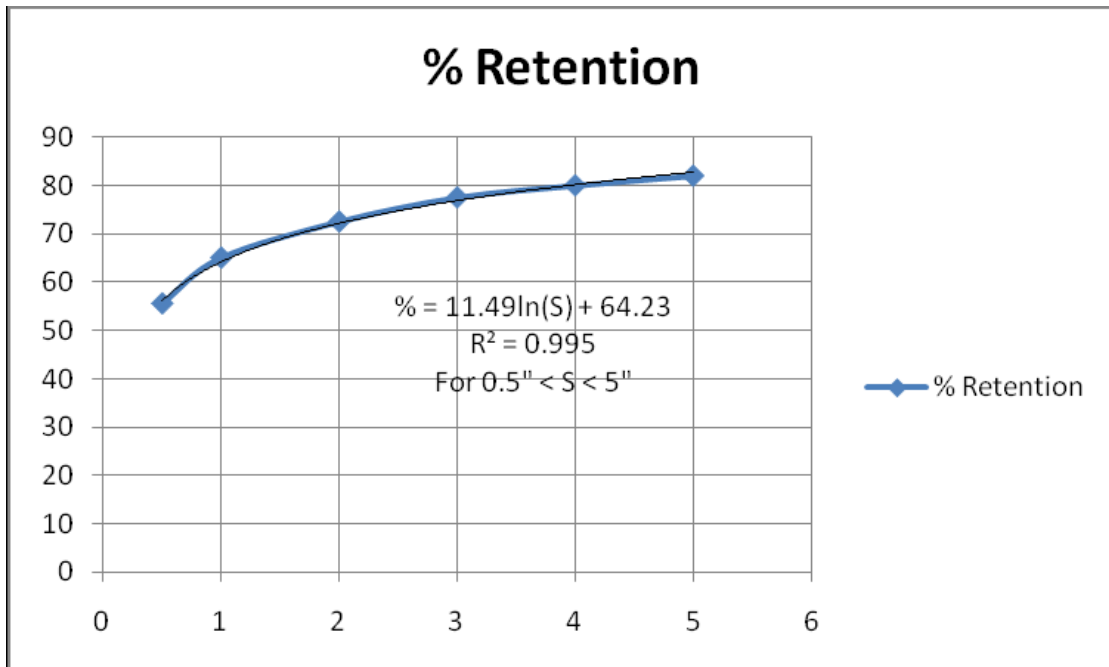
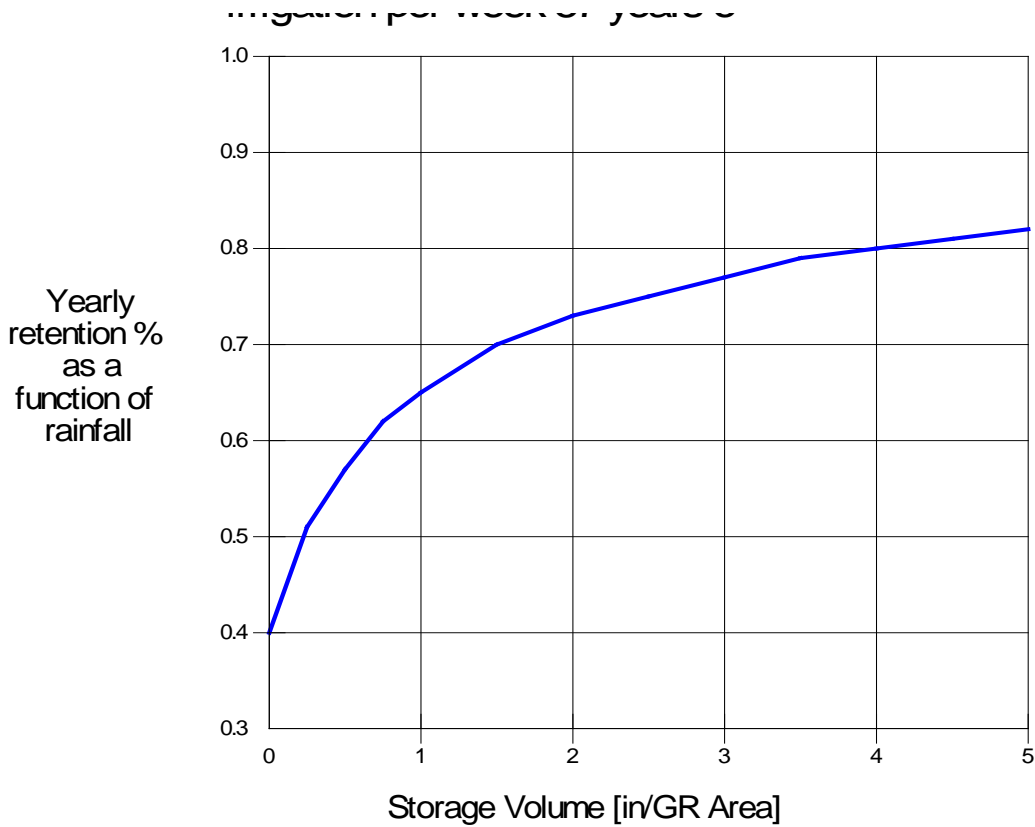

At Jacksonville, percent yearly retention by a greenroof with no cistern is 40%.

## Greenroof Harvesting Design Curve for Key West Florida Area Using 46 years of data

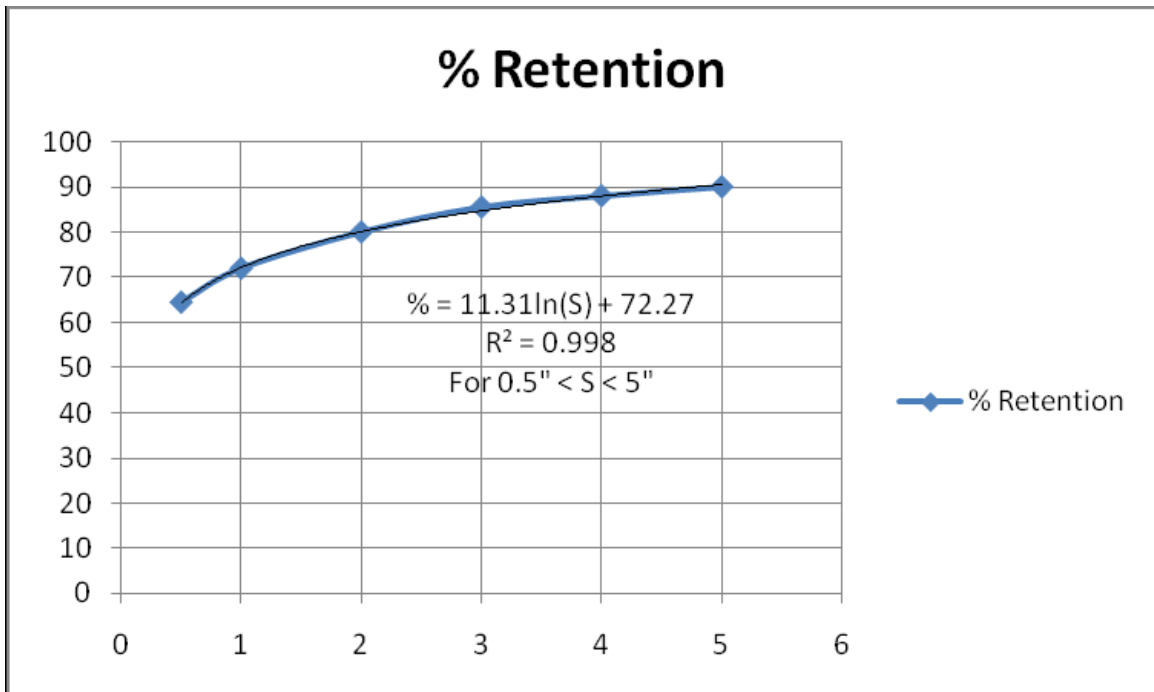
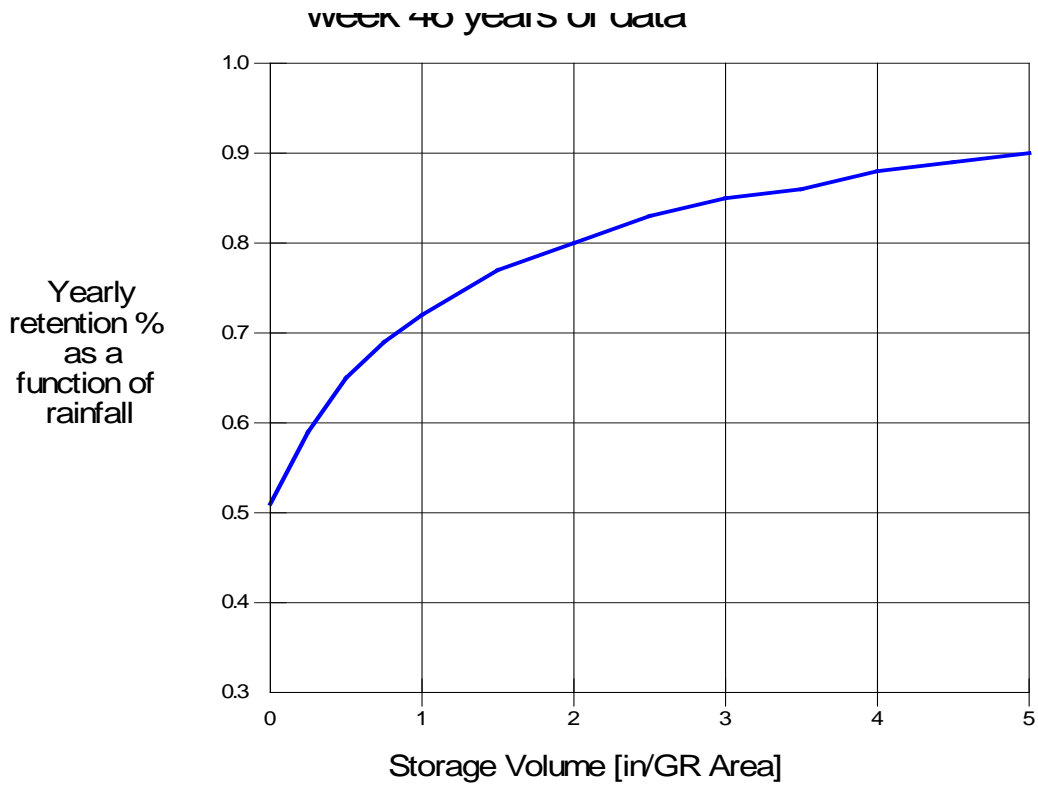

At Key West, percent yearly retention by a greenroof with no cistern is 51%.



## Greenroof Harvesting Design Curve for Lakeland Florida Area Using 32 years of data

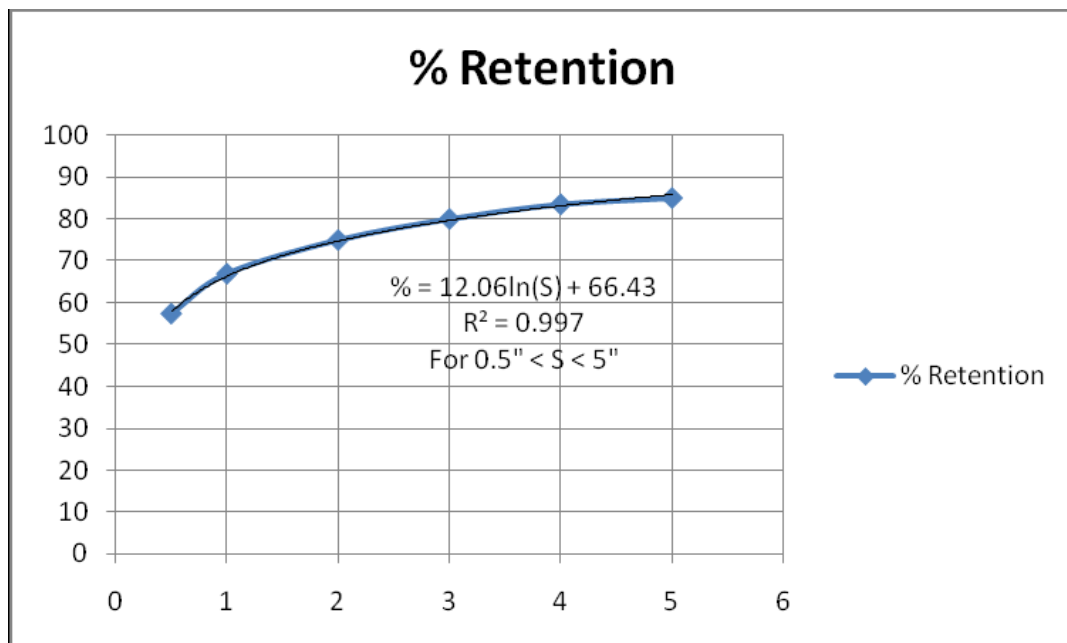
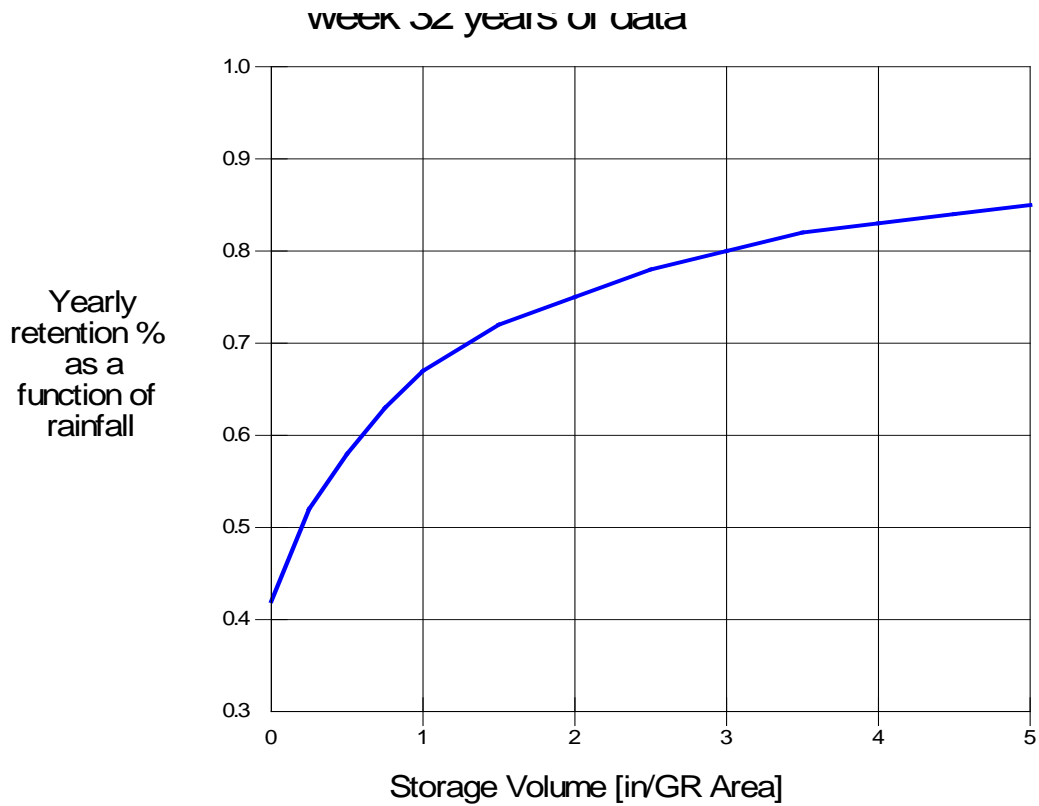

At Lakeland, percent yearly retention by a greenroof with no cistern is 42%.

## Greenroof Harvesting Design Curve for Miami Florida Area Using 55 years of data

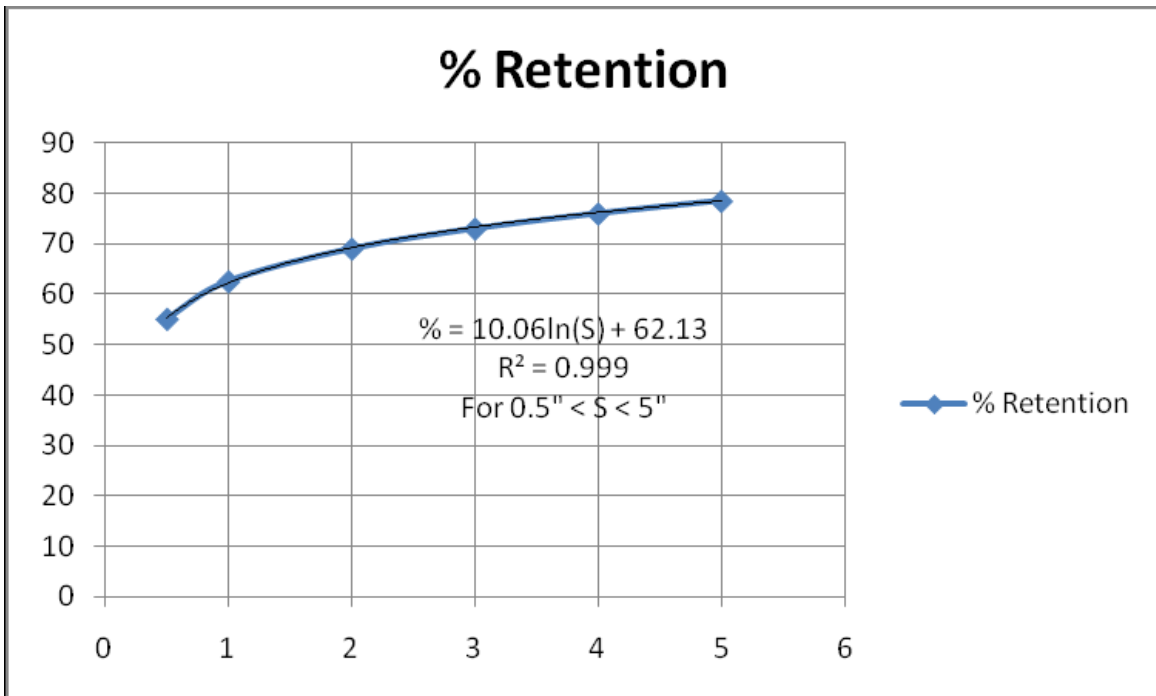
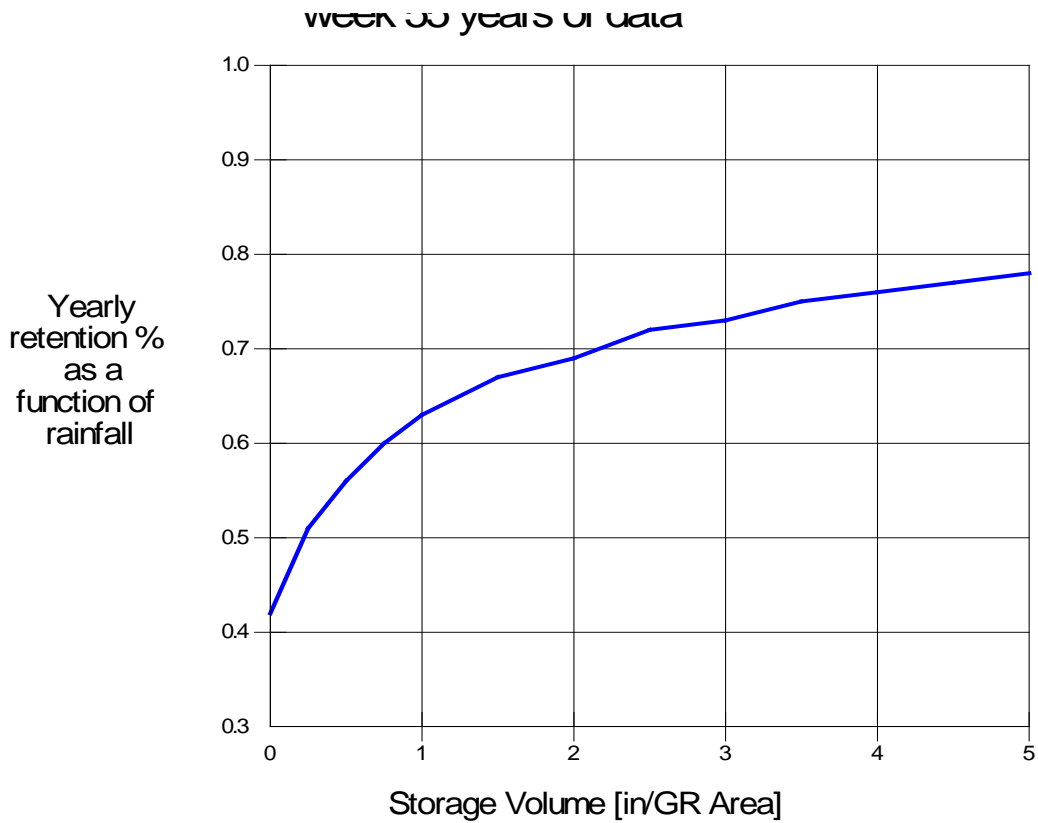

At Miami, percent yearly retention by a greenroof with no cistern is 42%.

# Greenroof Harvesting Design Curve for Niceville Florida Area Using 46 years of data

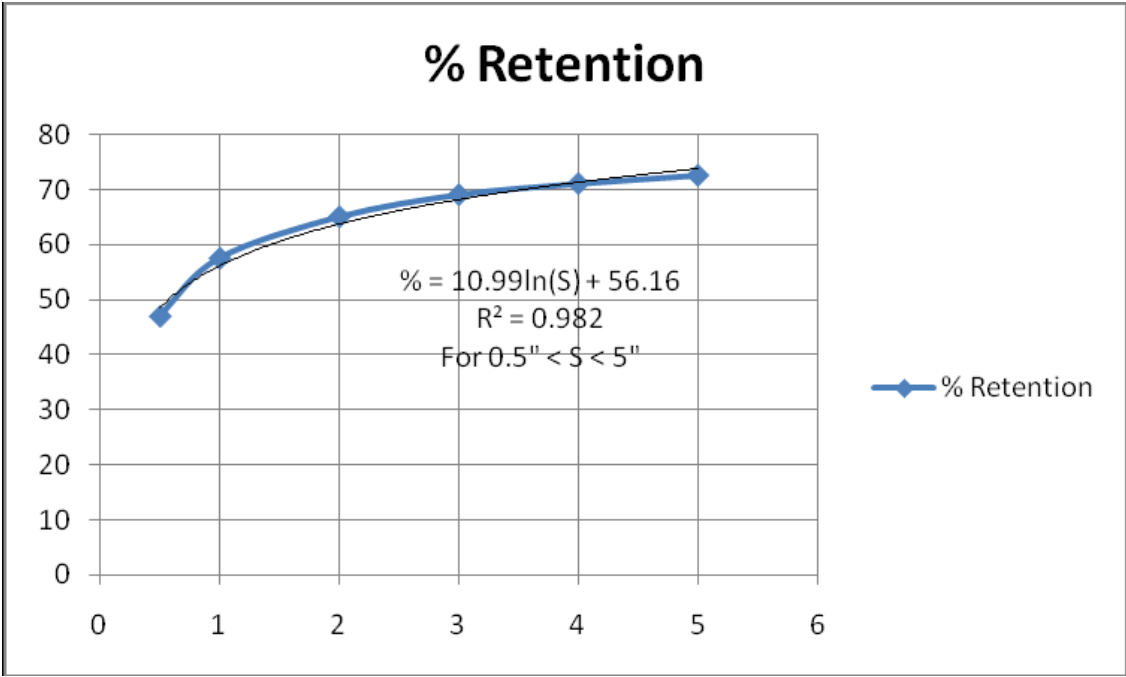
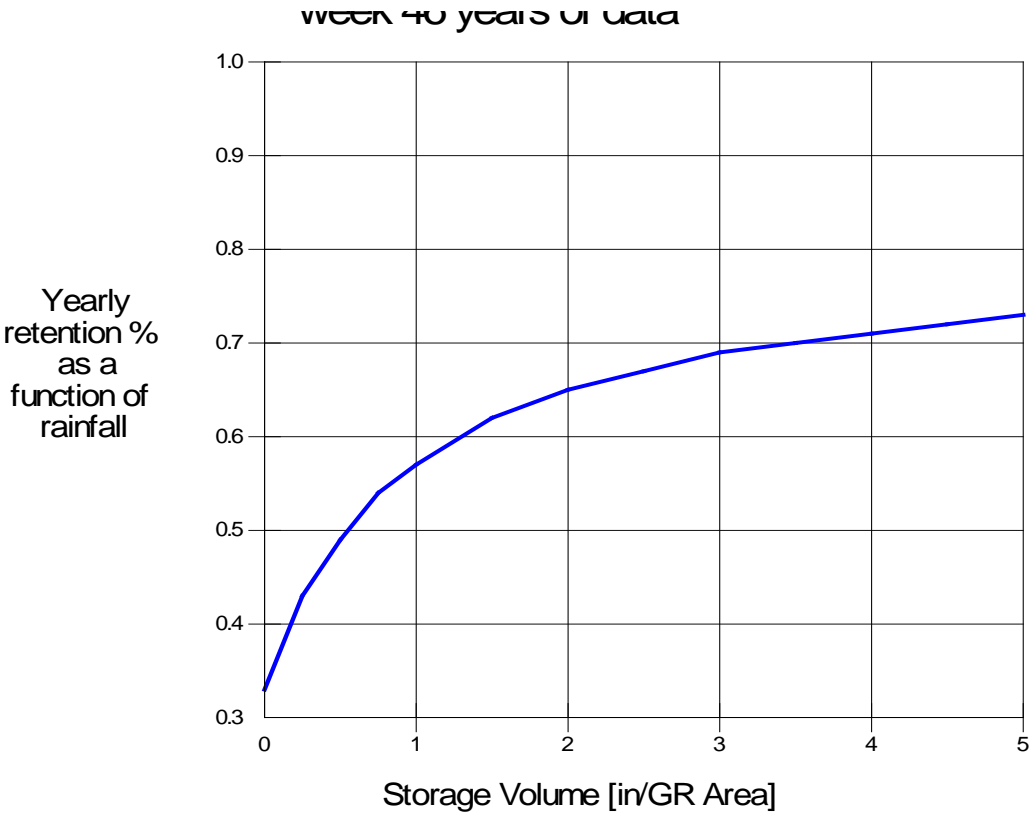

At Niceville, percent yearly retention by a greenroof with no cistern is 33%.

## Greenroof Harvesting Design Curve for Orlando Florida Area Using 30 years of data

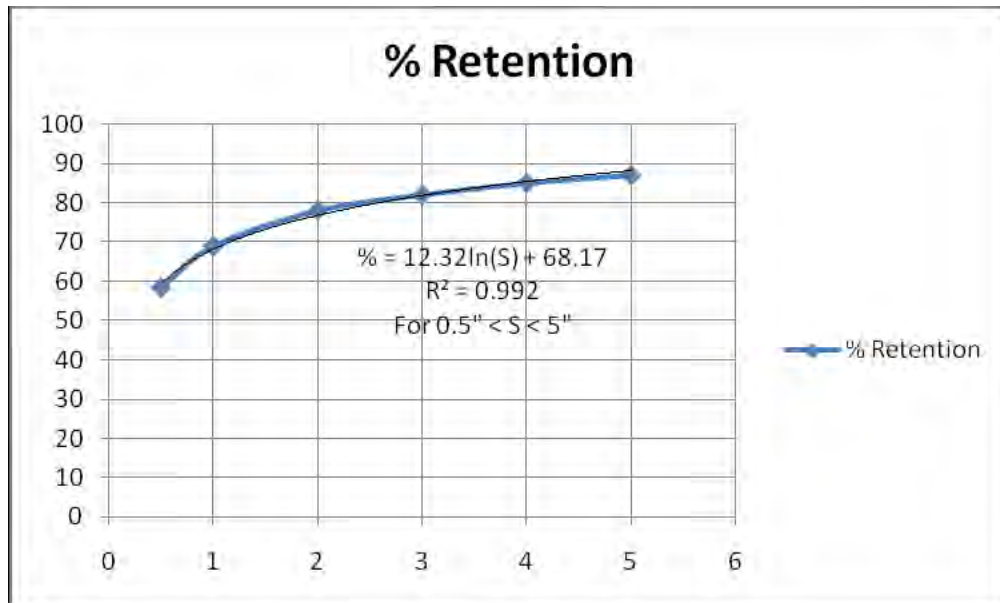
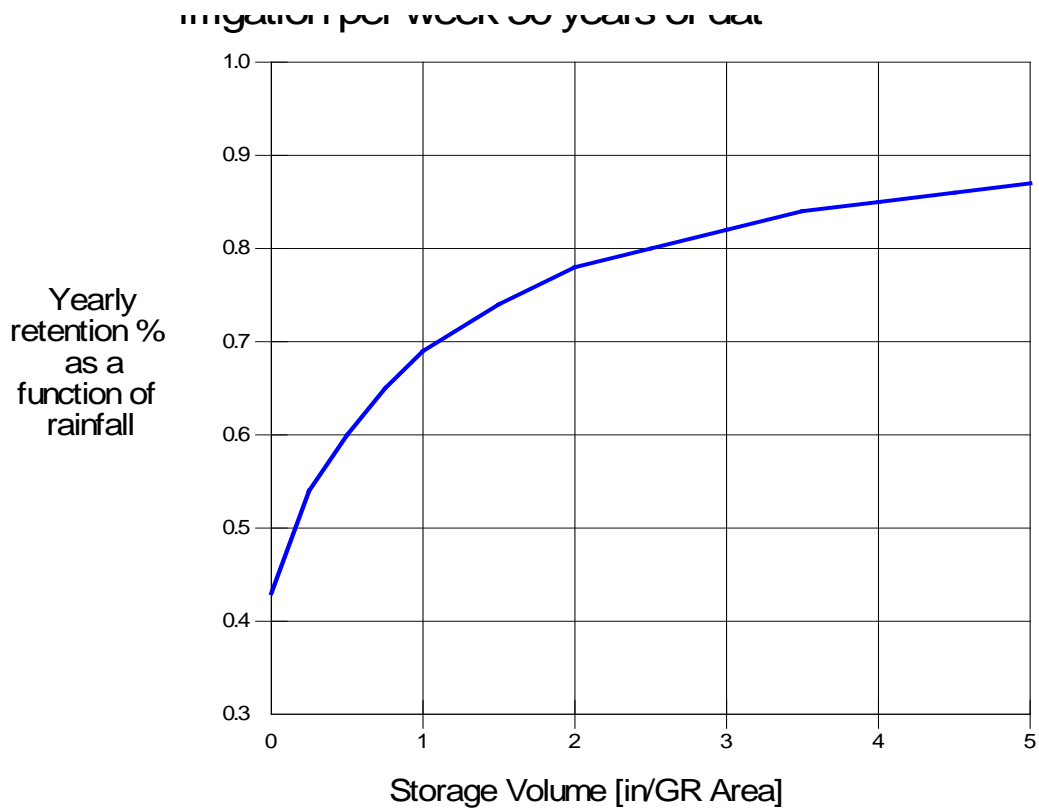

At Orlando, percent yearly retention by a greenroof with no cistern is 43%.

## Greenroof Harvesting Design Curve for Panama City Florida Area Using 32 years of data

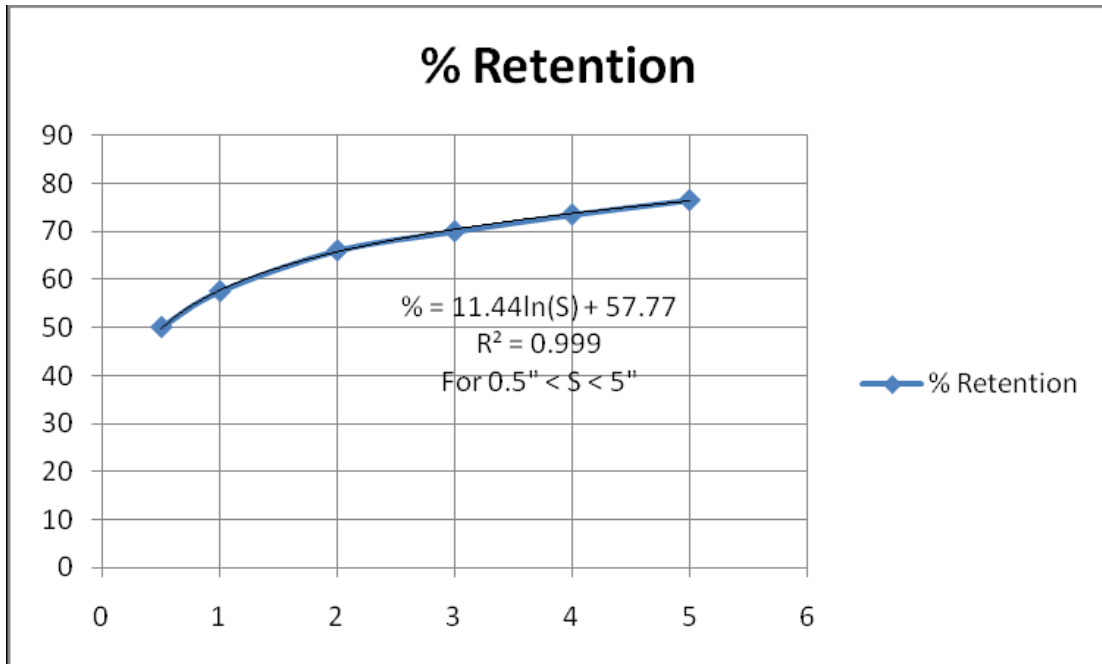
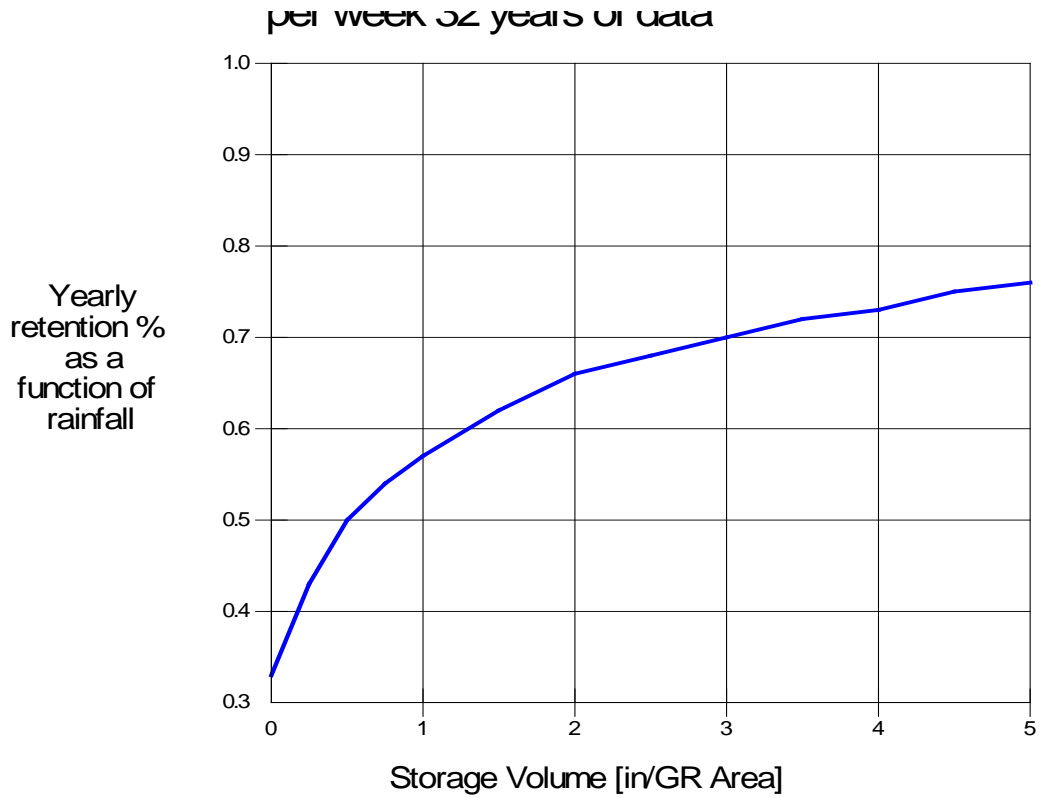

At Panama City, percent yearly retention by a greenroof with no cistern is 33%.

## Greenroof Harvesting Design Curve for Tallahassee Florida Area Using 46 years of data

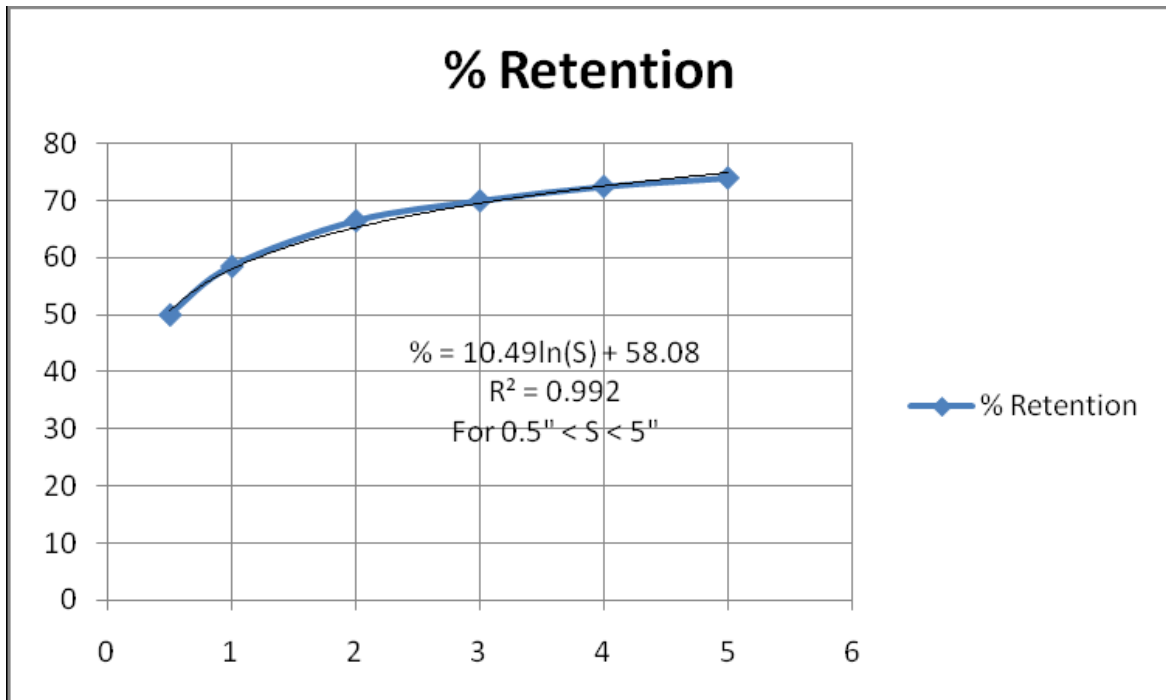
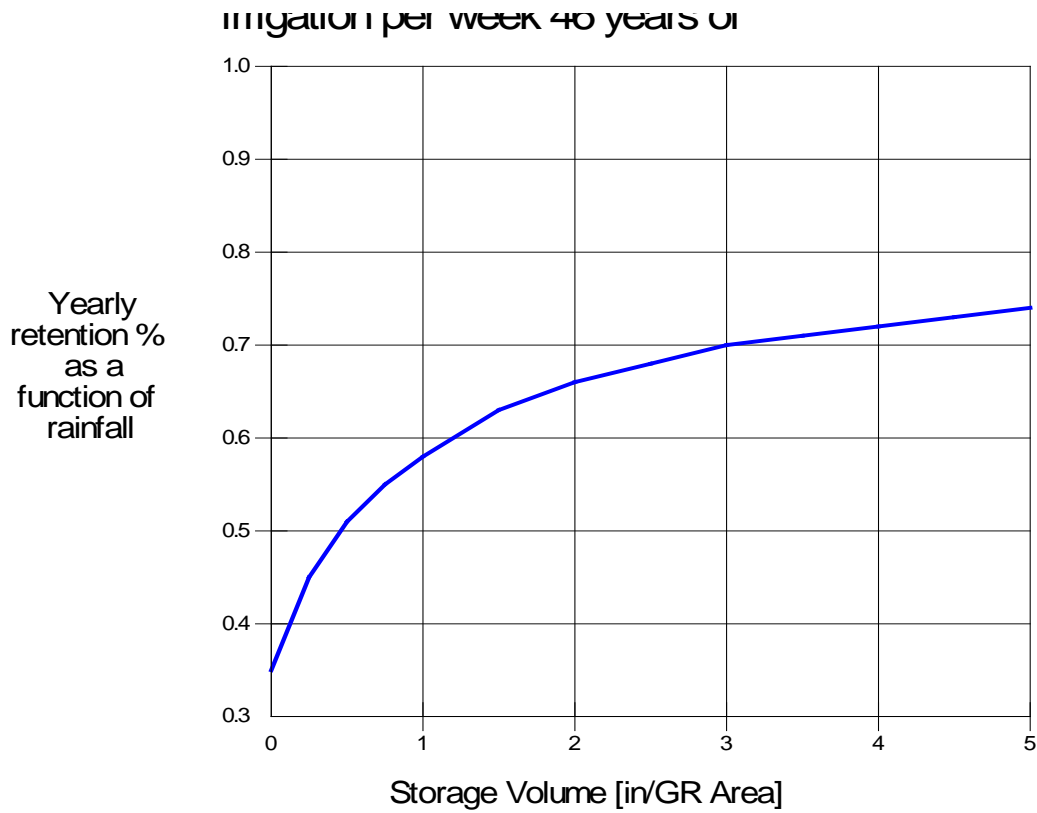

At Tallahassee, percent yearly retention by a greenroof with no cistern is 35%.

## Greenroof Harvesting Design Curve for Tampa Florida Area Using 45 years of data

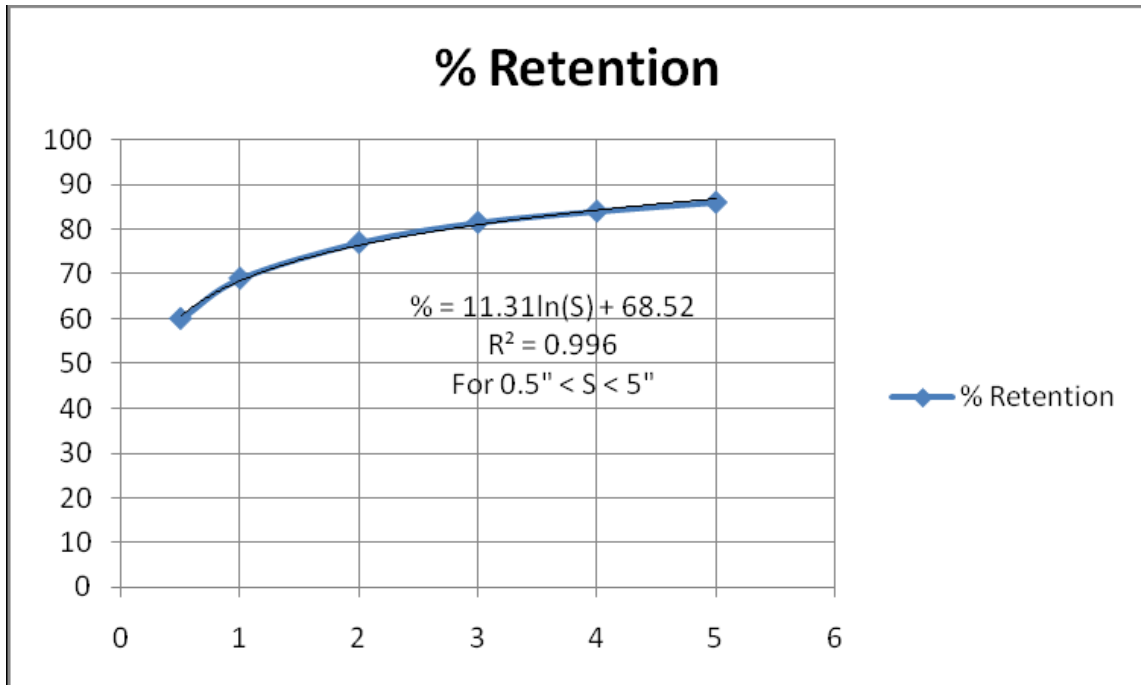
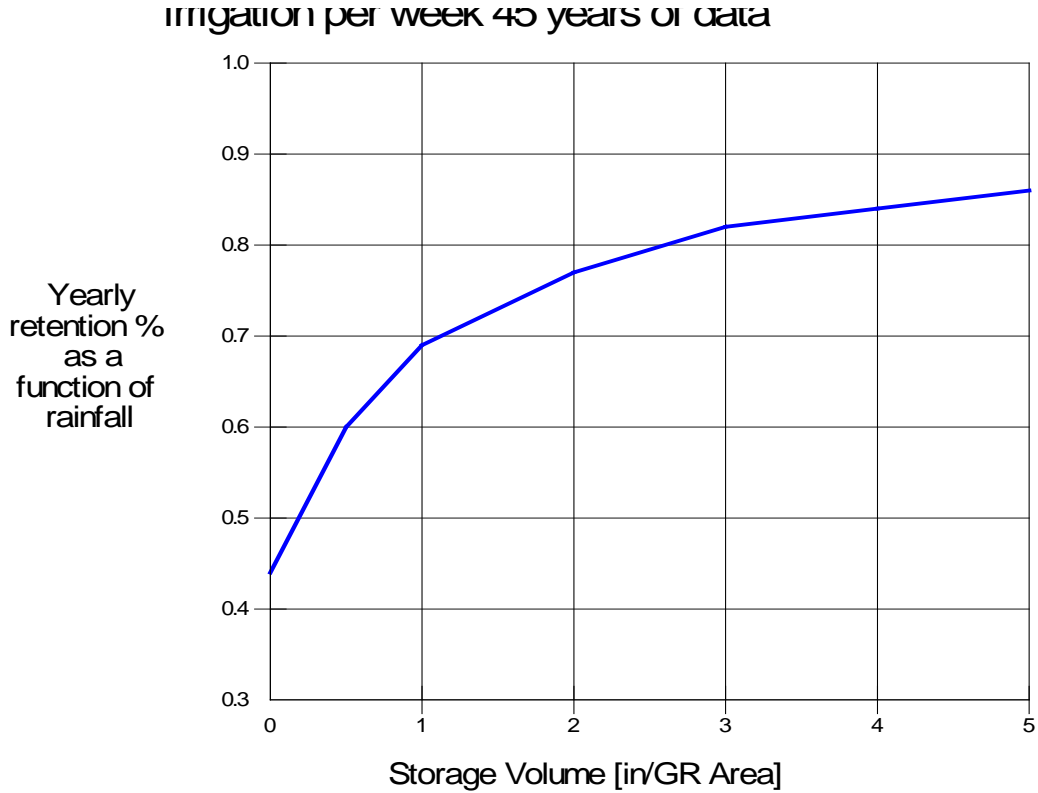

At Tampa, percent yearly retention by a greenroof with no cistern is 44%.

## Greenroof Harvesting Design Curve for Venice Florida Area Using 62 years of data

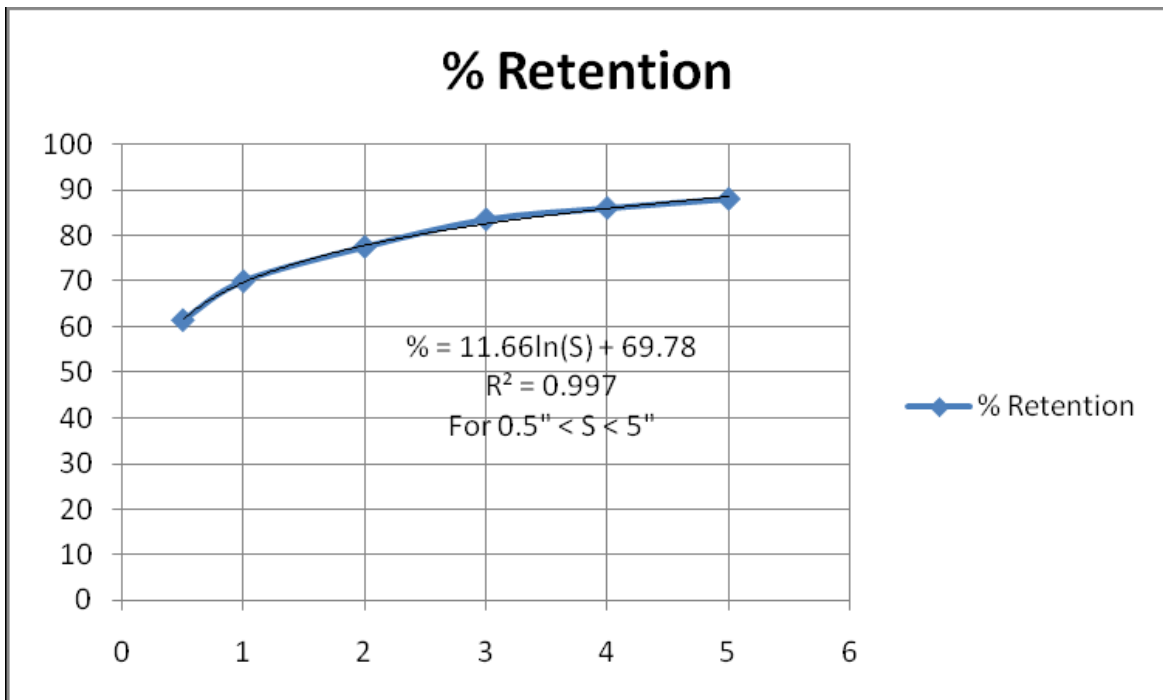
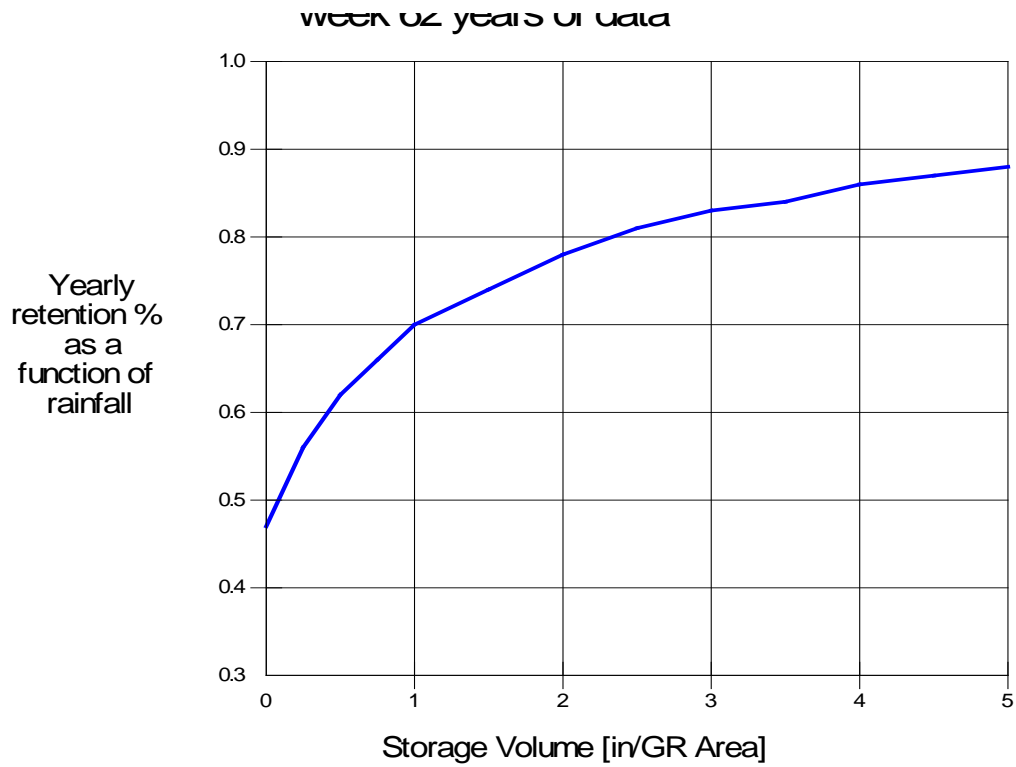

At Venice, percent yearly retention by a greenroof with no cistern is 47%.



# Greenroof Harvesting Design Curve for West Palm Florida Area Using 62 years of data

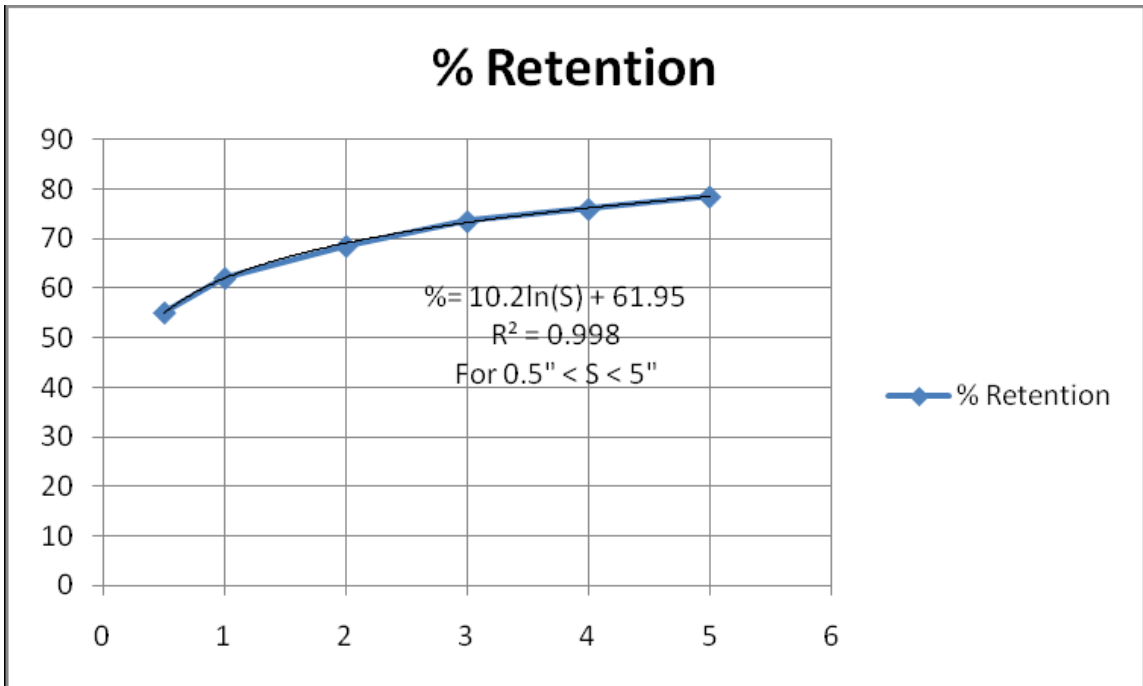
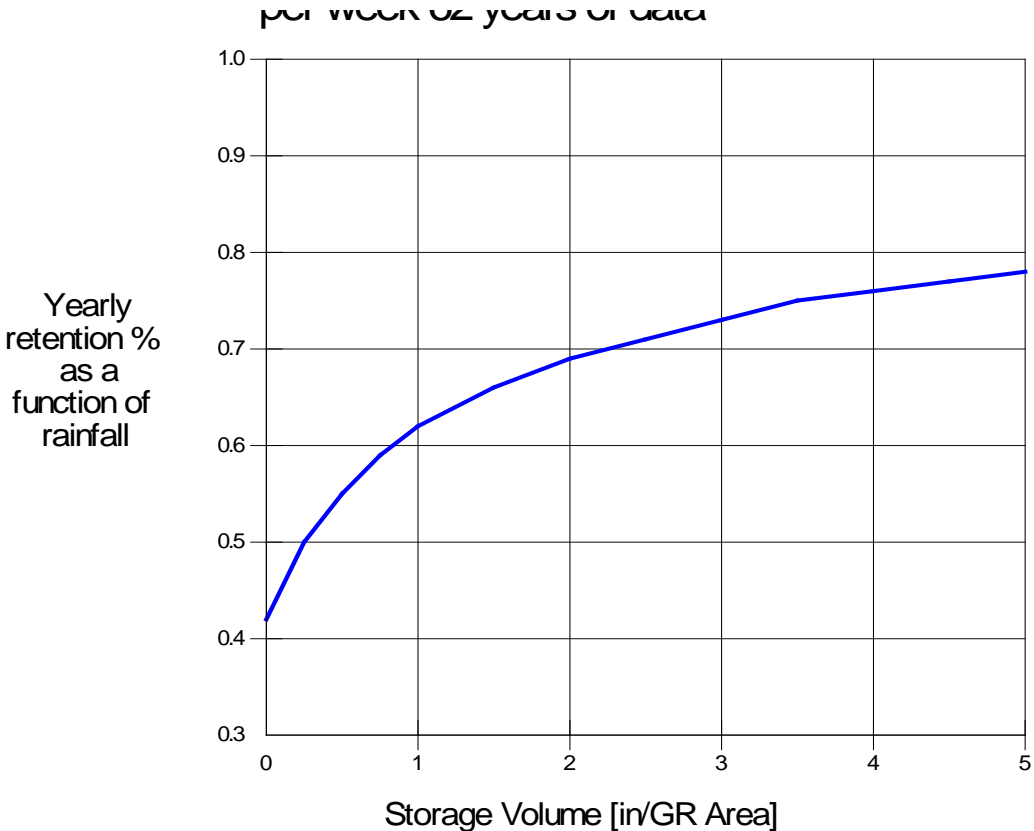

At West Palm, percent yearly retention by a greenroof with no cistern is 42%.

## **13.0 WET DETENTION SYSTEMS**

### **13.1 Description**

Wet detention systems are permanently wet ponds which are designed to slowly release a portion of the collected stormwater runoff through an outlet structure. A schematic of a typical wet detention system is shown in **Figure 13.1**.

Wet detention systems are the recommended BMP for sites with moderate to high water table conditions. The Agency strongly encourages the use of wet detention treatment systems for the following two reasons. First, wet detention systems provide removal of both dissolved and suspended pollutants by taking advantage of physical, chemical, and biological processes within the pond. Second, the complexity of BMPs, such as underdrains, is not encountered in a wet detention pond control structure. Wet detention systems offer an effective alternative for the long term control of water levels in the pond, provide a predictable recovery of storage volumes within the pond, and are easily maintained by the maintenance entity.

There are several components in a wet detention system which must be properly designed to achieve the level of stormwater treatment described herein. A description of each design feature and its importance to the treatment process is presented below. The design and performance criteria for wet detention systems are discussed below. **Section 23** of this Handbook provides design examples and calculations for designing wet detention systems.

### **13.2 Treatment required**

The required nutrient load reduction will be determined by type of water body to which the stormwater system discharges and the associated performance standard as set forth in **Section 3.1** of this Handbook.

### **13.3 Bleed-down Volume**

The bleed down volume shall be the first one inch of runoff from the contributing area. For wet detention systems, the bleed-down volume is defined between the elevation of the overflow weir and the control elevation. The overflow weir is generally set to accommodate stormwater quantity and flood control criteria. The control elevation is the “normal” water level for the pond. It is established as the higher elevation of either the normal wet season tailwater elevation or the SHGWT minus six inches, unless this creates adverse impacts to wetlands at or above the control water table elevation. The maximum stage above the control elevation for providing the bleed-down volume shall not exceed EIGHTEEN inches unless the applicant demonstrates, based on plans, test results, calculations or other information, that an alternative design is appropriate for the specific site conditions.

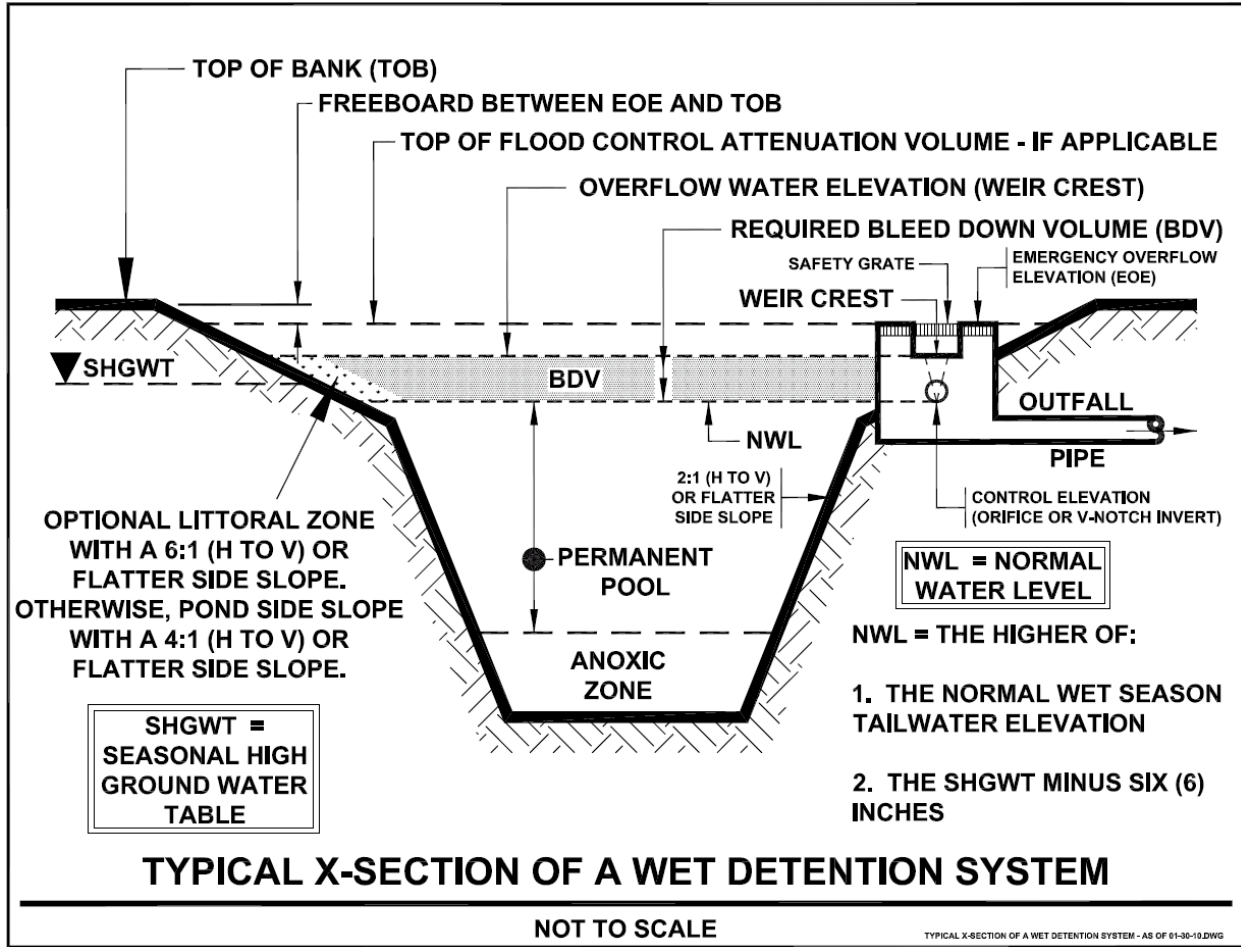

Figure 13.1 Typical Cross Section of a Wet Detention System

13.4 Design Criteria

- (a) **Required nutrient reduction** - The wet detention system, either by itself or as part of a BMP treatment train, shall achieve the required level of nutrient load reduction as specified in Section 3.1 of this Handbook.
- (b) **Permanent Pool** - The most significant component and design criterion with respect to nutrient load reduction of a wet detention system is the storage capacity of the permanent pool (i.e., the section of the pond that holds water at all times). Important pollutant removal processes that occur within the permanent pool include: uptake of nutrients by algae, adsorption of nutrients and heavy metals onto bottom sediments, biological oxidation of organic materials, and sedimentation. Uptake by algae is one of the most important process for the removal of nutrients. Sedimentation and adsorption onto bottom sediments is likely the primary means of removing heavy metals.

The permanent pool shall be sized to provide a residence time that achieves the required nutrient removal efficiency, if possible. It is recognized that required treatment efficiencies may not be achievable with a wet detention system alone, due to inherent limitations associated with this BMP. Residence time shall be based upon annual rainfall volumes. Also,

it is recognized that wet detention systems used in-series also have limitations regarding the maximum treatment that can be expected, resulting in so-called irreducible concentrations, below which the BMP is incapable of treating. Irreducible concentrations for TN and TP are established as 0.40 and 0.010 mg/L, respectively. In the case where the wet detention system alone cannot achieve the required treatment efficiency, a BMP treatment train must be used that incorporates other BMPs. Methodologies for the use of BMPs in series and the calculation of nutrient load reduction are described in **Section 1.3** of this Handbook. Design examples for wet detention systems are found in **Section 23** of this Handbook.

The relationship between removal efficiency of total phosphorus in wet detention ponds as a function of mean annual residence time is given in **Figure 13.2**. The best-fit relationship for the remaining data was obtained using a second-order relationship involving the natural log of the residence time. The best-fit equation is also provided on **Figure 13.2** for the relationship between total phosphorus removal efficiency and residence time. This equation provides an extremely good fit between the two variables, with an  $R^2$  of 0.979. This value indicates that residence time explains approximately 97% of the observed variability in removal efficiencies for total phosphorus in wet detention ponds.

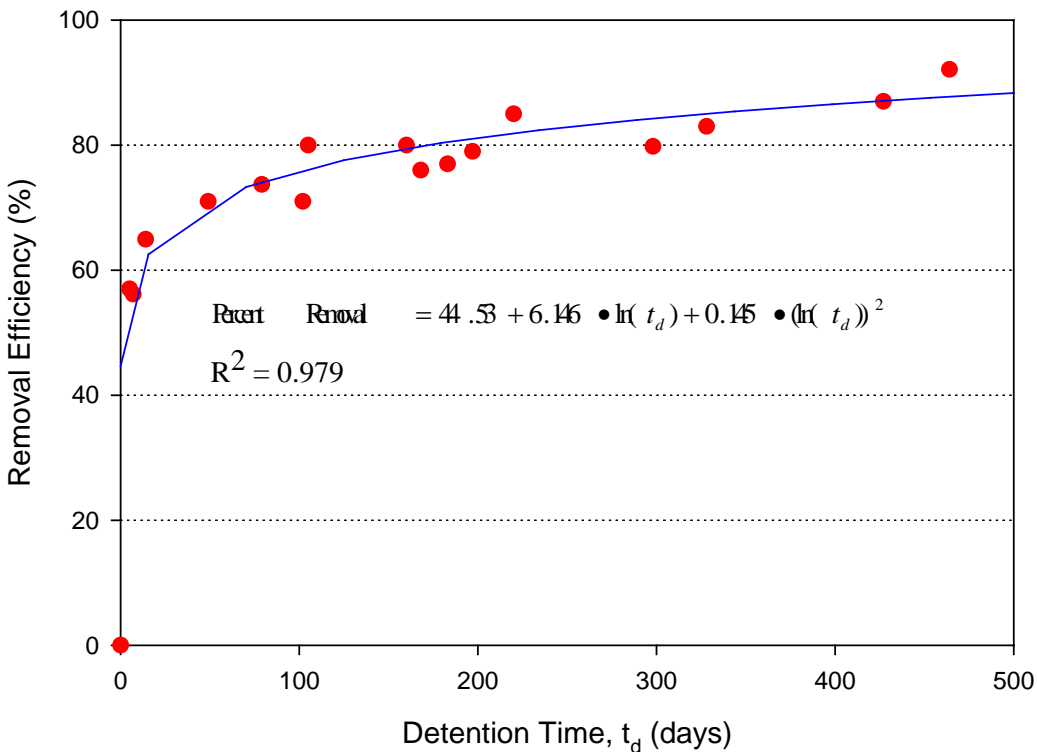

**Figure 13.2 Removal Efficiency of Total Phosphorus in Wet Detention Ponds as a Function of Residence Time**

Relationships between mean annual residence time and removal efficiencies for total nitrogen in wet detention ponds for stormwater are illustrated in **Figure 13.3**. The best-fit for the relationship between removal efficiency and residence time for total nitrogen was obtained using a hyperbolic equation for stormwater. The final version of this equation is also summarized on **Figure 9.3b**. The  $R^2$  value of 0.800 suggests that residence time explains approximately 80% of the observed variability in removal efficiencies for total nitrogen in wet detention ponds.

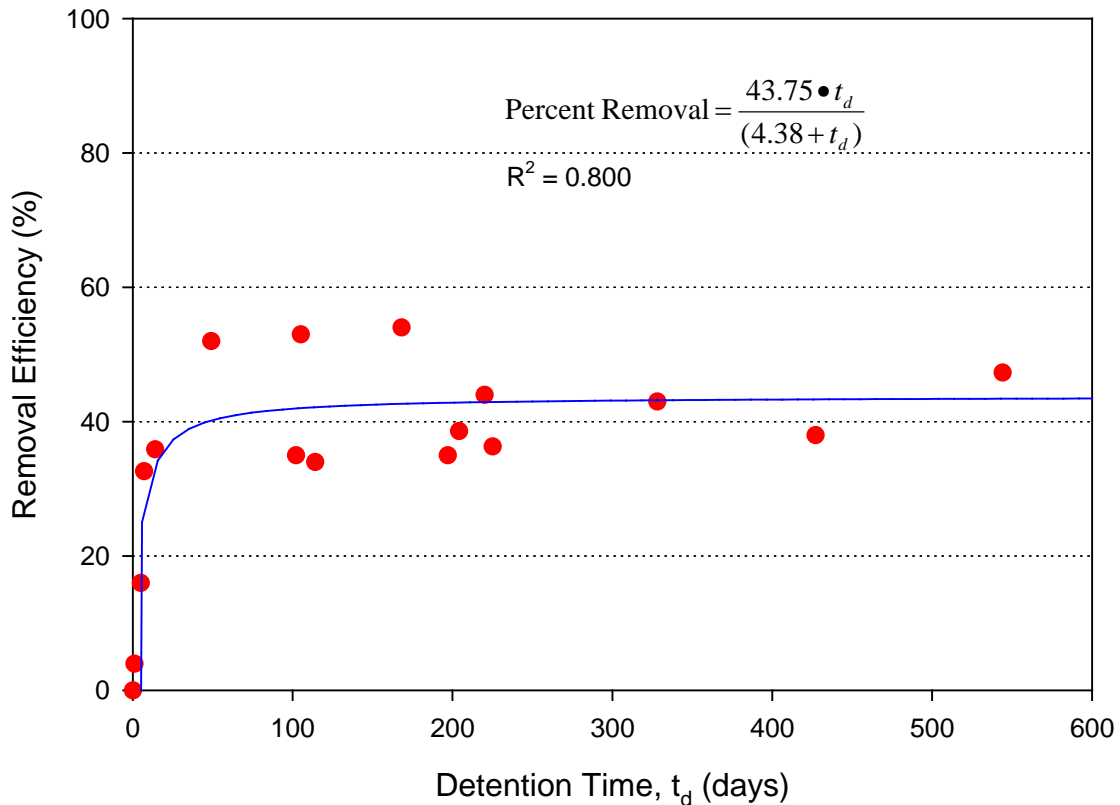

**Figure 13.3 Removal Efficiency of Total Nitrogen in Wet Detention Ponds as a Function of Residence Time**

- (c) **Pond Depth** – The maximum depth to be used in calculating the water quality permanent pool volume shall be no greater than 12 feet, unless the applicant demonstrates, based on Equation 13-1 and as described in Section 23.3 of this Handbook, that an alternative depth is appropriate for the specific site conditions. The maximum allowable permanent pool depth as it relates to the aerobic zone is directly related to the anticipated algal productivity within the pond. The maximum depth of the pond may be deeper, provided the applicant demonstrates that permanent pool credit for deeper pond depths only includes volumes that are based on the depth below the control elevation that remains aerobic throughout the year (based on a monthly analysis). The general relationship for determining the depth to anoxic conditions is expressed as the following equation:

**Equation 13-1:**

$$\text{Depth of } DO < 1 = 3.035 * \text{Secchi} + 0.02164 * (\text{chl-a}) - 0.004979 * \text{Total P}$$

Where: *DO* = dissolved oxygen (mg/L)  
*Secchi* = estimated Secchi depth (meters)  
*Chyl a* = estimated chlorophyll a (mg/m<sup>3</sup>)  
*Total P* = estimated total phosphorus (ug/L)

The above calculation must be performed on a monthly basis in order to determine the most limiting time of year (month with shallowest depth to the anoxic zone). Alternatively, the

depth to the anoxic zone can be calculated using **Equation 13-1** for average annual conditions, and multiplying the resultant depth by 0.75. Additional methods and assurances shall be required if the wet pond is anticipated to receive sediment or nutrient loads in excess of those calculated from the EMCs in **Appendix B** since **Equation 13-1** may not be applicable for that condition. **Section 23.3** of this Handbook provides example calculations for determining the maximum allowable depths for permanent pools.

The mean pond depth shall be at least 6 (six) feet unless an applicant demonstrates that an alternative depth is appropriate for the specific site conditions. The mean pond depth is calculated by dividing the pond volume at the normal water level elevation by the surface area of the pond at the normal water level elevation. The mean depth requirement is necessary to ensure a minimum depth throughout the pond that will reduce opportunities for nuisance plant species to be established. If a shallower mean depth is proposed for the site, the permittee shall be required to implement additional operating and maintenance provisions to assure that the system does not become dominated by cattails or other undesirable vegetation.

- (d) **Pond Configuration** - It is important to maximize the flow path of water from the inlets to the outlet of the pond to promote good mixing of stormwater. Under these design conditions, short circuiting is minimized and pollutant removal efficiency and mixing is maximized. The flow weighted average inlet to outlet ratio, or flow path ratio (FPR), shall be 0.80 or greater, using the following methodology:

For each inlet, using the percent of inflow, calculate the FPR using **Equation 13-2**

**Equation 13-2** Flow Path Ratio (FPR) =  $\text{SUM} ((A/LP)_i * V_i)$

Where:  $A_i$  = actual travel distance for inflow  $i$   
 $LP_i$  = longest possible travel distance for inflow  $i$   
 $V_i$  = fraction of annual runoff volume contributed by inflow  $i$

If short flow paths are unavoidable, the effective flow path can be increased by adding diversion barriers such as islands, peninsulas, or baffles to the pond. Inlet structures shall be designed to dissipate the energy of water entering the pond. See examples in **Appendix I**.

- (e) **Control Elevation** - The control elevation is the “normal” water level for the pond. The control elevation shall be established as the higher elevation of either the normal wet season tailwater elevation or the SHGWT minus six inches, unless this creates adverse impacts to wetlands at or above the control water table elevation. However, variation of site conditions throughout the state may allow deviation from this requirement. Accordingly, an applicant may request the Agency to approve another control elevation based upon evaluation of the proposed elevation on:
- Maintaining existing water table elevations in existing wellfield cones of depression;
  - Maintaining water table elevations needed to preserve environmental values at the project site and prevent the waste of freshwater;
  - Maintaining minimum flows or levels of surface waters established pursuant to Section 373.042, F.S.
  - Assuring that water table elevations will not be lowered such that the existing rights of others will not be adversely affected;
  - Preserving ground water recharge characteristics of the project site;
  - Maintaining ground water levels needed to protect wetlands and other surface waters;

- Creating adverse impacts on surrounding land and project control elevations and water tables;
- Creating conflicts with water use permitting requirements or water use restrictions;

The Agency will approve an alternative control elevation and its effects on the factors above based on a demonstration by the applicant, using plans, test results, calculations or other information, that the alternative design is appropriate for the specific site conditions and will meet the above considerations.

- (f) **Ground water nutrient loads** - If the control elevation is located more than six inches below the SHGWT, nutrient loads from baseflows must be accounted for in the nutrient loading and nutrient removal calculations.
- (g) **Reclaimed water nutrient loads** – If reclaimed water is discharged into a wet detention system that will discharge, the nutrient loads from the reclaimed water must be accounted for in the nutrient loading and nutrient removal calculations.
- (h) **Recovery Time** - The outfall structure shall be designed to drawdown one half of the required bleed-down volume within 24 hours to 30 hours. If the minimum bleed-down device specified in (i) below will result in a quicker drawdown it will be allowed.
- (i) **Outlet Structure** - The outlet structure generally includes a drawdown device (such as an orifice, "V" or square notch weir) set to establish a normal water control elevation and slowly release the bleed-down volume (see **Figures 13.4** and **13.5** for schematics). The design of the outfall structure must also accommodate the passage of base flows or flows from upstream stormwater management systems, if applicable (see **Figure 13.6**).

Also, drawdown devices shall incorporate minimum dimensions no smaller than 2 inches minimum width or less than 20 degrees for "V" notches. Bleed-down devices incorporating dimensions smaller than 6 inches minimum width or less than 45 degrees for "V" notches shall include a device to minimize clogging. Examples of such devices include baffles, grates, screens, gravel filled corrugated metal pipes, and pipe elbows.

- (j) **Pond Side Slopes** –For purposes of public safety, wet detention basins shall be restricted from public access or contain side slopes that are no steeper than 4:1 (horizontal:vertical) from the top of bank out to a depth of two feet below the control elevation, except as provided in Section 7.4(d) and (e) of the SFWMD Basis of Review for Environmental Resource Permit Applications, and in Section 6.4.1.c and in Section 6.4.1.d of the SFWMD Environmental Resource Permitting Information Manual, Part B, Basis of Review. All side slopes shall be stabilized by either vegetation or other materials to minimize erosion and subsequent sedimentation of the pond. Deeper areas of the pond must maintain horizontal to vertical side slopes no steeper than 2H:1V.
- (k) **Littoral Zones** - If the applicant proposes to include a littoral zone, the design shall meet the requirements in **Section 14.3** of this Handbook.
- (l) **Removal of Exotic or Nuisance Plant Species** – In wet detention ponds without a littoral zone, exotic or nuisance species such as cattails or primrose willow shall be removed as necessary to prevent their long term establishment.

### 13.5 Required Site Information

Successful design of a wet detention system depends heavily upon conditions at the site, especially information about the soil, geology, and water table conditions. At a minimum, site specific information on the depth to the seasonal high ground water table and the presence and location of aquitard/confining unit is required when designing a wet detention system. Information related to determining the SHGWT, the location of aquitards/confining layers, and hydraulic conductivity (if applicable for radius of influence and ground water inflow computations) is specified in **Section 21.6** of this Handbook.

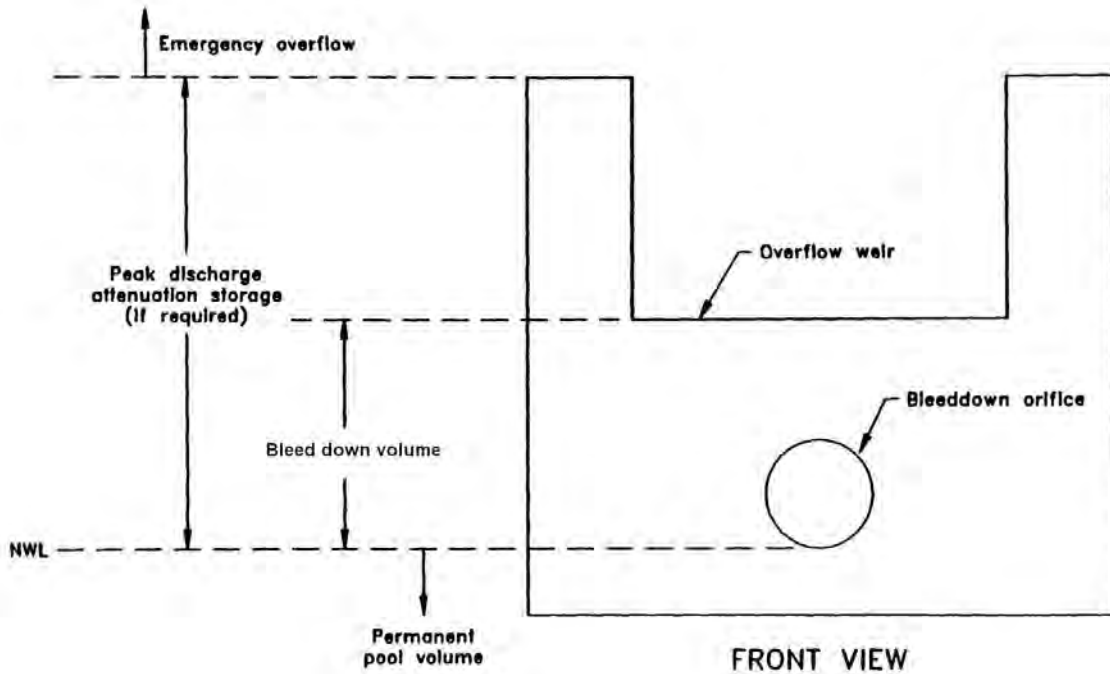

Figure 13.4a Typical Wet Detention Outfall Structure (N.T.S.)



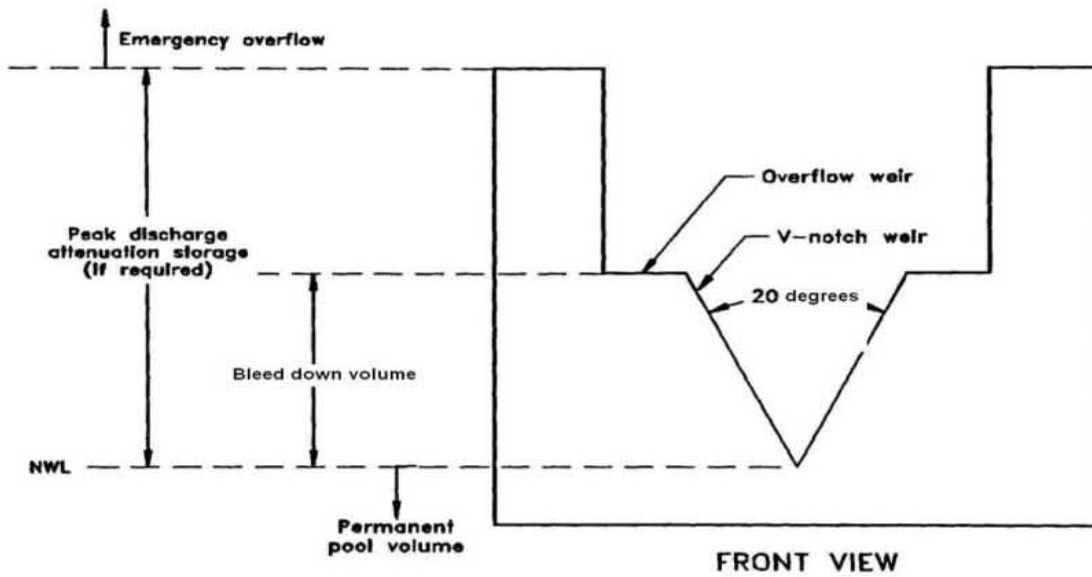

Figure 13.5 Typical Wet Detention Outfall Structure with "V"-notch Weir (N.T.S.)

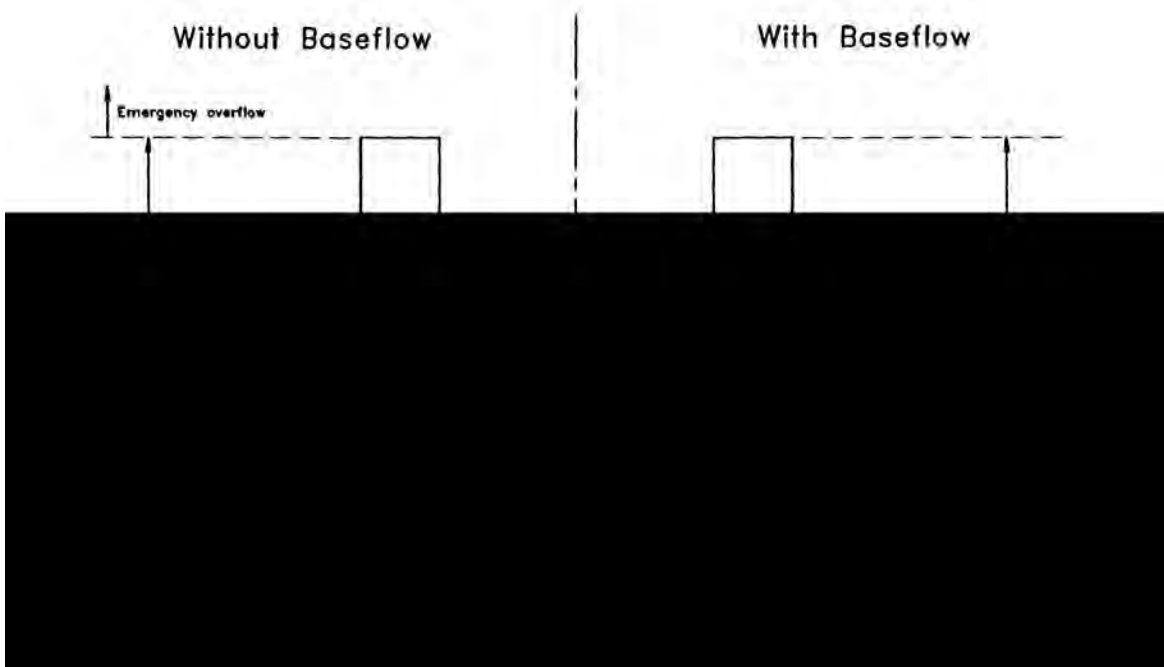
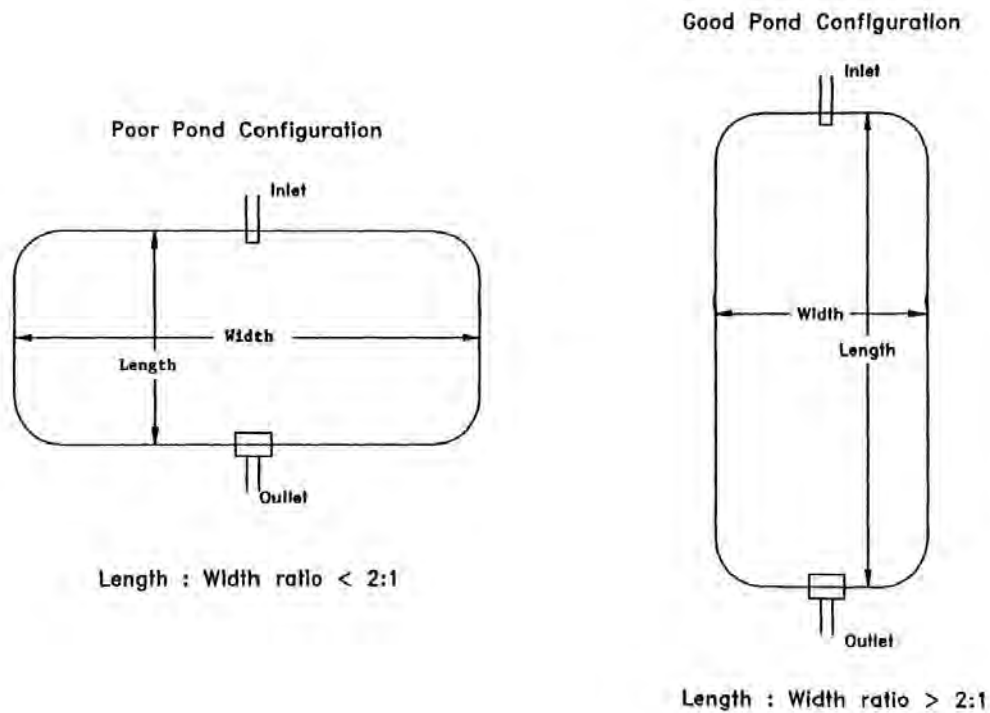

Figure 13.6 Typical Wet Detention Outfall Structure With and Without Baseflow Conditions (N.T.S.)



**Figure 13.7 Examples of Good and Poor Wet Detention Pond Configurations (N.T.S.)**

### 13.6 Detention Pond Construction

Wet detention basin construction procedures are important in assuring the long term operation and safety of the system, especially if the pond is constructed using an embankment rather than through excavation. In either case, it is important that the discharge structure be properly designed and constructed to prevent its failure.

The following construction procedures are required to assure proper construction of the wet detention pond:

- (a) The location and dimensions of the detention pond shall be verified onsite prior to its construction. All design requirements including detention pond dimensions and distances to foundations, septic systems, and wells need to be verified.
- (b) Once excavation of the wet detention pond begins, the soil types need to be verified to ensure that they are suitable for the pond.
- (c) If the wet detention pond is being created by construction of an embankment, rather than solely through excavation, special attention during construction must be focused on the embankment's construction, especially of any pipes that are part of the discharge structure that are built through the embankment.

- (d) To minimize the potential that an embankment will fail, inspection of the structure throughout it's construction are needed to assure that components such as anti-seep collars or diaphragms and soil compaction are done properly.
- (e) All elevations need to be verified in the field as construction occurs to assure that they are consistent with permitted plan specifications.
- (f) All inlets and outlets shall be stabilized as set forth in the permitted plans to prevent erosion, scour, and sedimentation.

An applicant may propose alternative construction procedures to assure that the design infiltration rate of the constructed and stabilized retention basin is met.

### ***13.7 Inspections, Operation and Maintenance***

Maintenance issues associated with wet detention ponds include assuring that sediments are not accumulating to such a degree that they are decreasing the required storage volume and assuring that all inlets, outlets, and discharge structures are not clogged or damaged structurally.

(a) Inspection Items:

- (1) Inspect basin for excessive sediment accumulations that decrease the wet detention pond's permitted storage volume.
- (2) Inspect inflow and outflow structures, trash racks, skimmers, and other system components for accumulation of debris and trash that would cause clogging and adversely impact operation of the wet detention pond.
- (3) If an embankment is used, inspect to ensure that no piping of water is occurring through the embankment and that there is no damage or structural integrity issues.
- (4) Inspect vegetation on side slopes to assure it is healthy, maintaining coverage, and that no erosion is occurring.
- (5) Inspect the wet detention pond for potential mosquito breeding problems
- (6) Inspect wet detention pond and, if applicable, littoral zone to assure that cattails or other invasive vegetation are not becoming established.

(b) Maintenance Activities As-Needed To Prolong Service:

- (1) If needed, remove accumulated sediments to restore permitted storage volume and dispose of properly Please note that stormwater sediment disposal may be regulated under Chapter 62-701, F.A.C. (See **Appendix I**)
- (2) Remove trash and debris from inflow and outflow structures, trash racks, and other system components to prevent clogging or impeding flow.
- (3) Maintain healthy vegetative cover to prevent erosion of side slopes or around inflow and outflow structures. Remove any trees or shrubs that may have become established on the discharge structure embankment, if applicable.

- (4) Eliminate mosquito breeding habitats such as thick growths of cattails and ensure that mosquito fish are present in the wet detention pond.
- (5) Remove cattails and other exotic vegetation from the littoral zone, if applicable, and replant appropriate vegetation if needed to meet littoral zone requirements.

## 14.0 MANAGED AQUATIC PLANT SYSTEM (MAPS) DESIGN CRITERIA

### 14.1 *Description*

Managed Aquatic Plant Systems (MAPS) are aquatic plant-based BMPs which remove nutrients through a variety of processes related to nutrient uptake, transformation, and microbial activities. Examples of MAPS include planted littoral zones and floating wetlands. In the latter example, harvesting of the biomass is an essential process of the BMP.

Generally, wet detention systems by themselves can't achieve the required levels of nutrient removal from stormwater. In nearly all cases, a BMP treatment train will be required when using a wet detention system. Sometimes components of the BMP treatment train include source controls or pretreatment BMPs such as retention or swales to reduce either the stormwater volume or nutrient concentrations in stormwater discharged to the wet detention system. However, in many areas, high water tables and slowly percolating soils do not make infiltration practices practical or effective. Managed Aquatic Plant Systems (MAPS) can be incorporated into a wet detention BMP treatment train to provide additional treatment and nutrient removal after the wet pond has provided reduction of pollutants through settling and other mechanisms that occur within the wet pond.

### 14.2 *Nutrient Removal Effectiveness and Credits*

The stormwater treatment nutrient removal effectiveness and credits for the different types of MAPS shall be based on data obtained from monitoring of these systems in Florida. The nutrient removal credits associated with MAPS shall be calculated using the BMP Treatment Train Equations set forth in **Section 1.3** of this Handbook. **Table 14.1** summarizes the proposed nutrient reduction credits based on the data that is currently available. It is anticipated that more data will become available and included during the rule adoption process.

**Table 14.1 Nutrient Removal Credits for MAPS**

Type of MAPS	TN Removal	TP Removal
Littoral zone	10%	10%
Floating Wetland Mats or Islands	20% - 40%	20% - 40%

The applicant must provide independent scientific data based on Florida field monitoring to validate the nutrient load reduction of any MAPS proposed for use.

### 14.3 *Littoral Zone Design Criteria*

Littoral zones are an optional component of wet detention systems. The littoral zone is that portion of a wet detention pond which is designed to contain rooted aquatic plants. The littoral area is usually provided by extending and gently sloping the sides of the pond down to a maximum depth of four feet below the normal water level or control elevation. One of the difficulties of successful littoral zone establishment and maintenance is the frequent changes in water level elevations within a wet detention pond. Experience has shown that long term survival of littoral zones is best when they are not located adjacent to private lots. Consequently, littoral zones typically are located near the outfall of a wet detention pond or along areas with common ownership. Littoral zones should also be considered in other areas of the pond that have depths suitable for successful plant growth such as a shallow shelf between the inflow sumps and the rest of the pond or on a shallow shelf in the middle

of the pond, provided maintenance can be undertaken. If treatment credit is proposed for littoral zones placed adjacent to private lots, the applicant shall provide additional assurances through their legal operation and maintenance documents or through an easement that the littoral zone will be maintained as permitted.

The littoral zone is established with native aquatic plants by planting and/or the placement of wetland soils containing seeds of native aquatic plants. A specific vegetation establishment plan must be prepared for the littoral zone. The plan must consider the water elevation fluctuations of the wet detention pond and the ability of specific plants to be established. A list of recommended native plant species suitable for littoral zone planting is included in **Table 14-2**. In addition, a layer of muck soil can be incorporated into the littoral area to promote the establishment of the wetland vegetation. When placing muck, special precautions must be taken to prevent erosion and turbidity problems in the pond and at its discharge point while vegetation is becoming established in the littoral zone.

The following is a list of the design criteria for wet detention littoral zones:

- (a) The littoral zone shall be gently sloped (6H:1V or flatter). At least 30 percent of the wet detention pond surface area shall consist of a littoral zone. The percentage of littoral zone is based on the ratio of vegetated littoral zone to surface area of the pond at the control elevation.
- (b) The bleeddown volume should not cause the pond level to rise more than 18 inches above the control elevation unless the applicant affirmatively demonstrates that the littoral zone vegetation can survive at greater depths.
- (c) Within 24 months of completion of the system, 80 percent coverage of the littoral zone area by suitable aquatic plants is required with no more than 10% consisting of exotic or nuisance species such as cattails or primrose willow.
- (d) Planting of the littoral zone is recommended to meet the 80% coverage requirement. As an alternative to planting, portions of the littoral zone may be established by placement of wetland top soils (at least a four inch depth) containing a seed source of desirable native plants. When using this alternative, the littoral zone must be stabilized by mulching or other means and at least the portion of the littoral zone within 25 feet of the inlet and outlet structures must be planted.
- (e) In parts of Florida, the Channelled Apple Snail has been shown to decimate littoral zone vegetation so designers need to be aware of this problem and will be required to provide additional assurances that damage done to the vegetation will be repaired within one month.
- (f) Replanting shall be required if the percentage of vegetative cover falls below the permitted level. The native vegetation within the littoral zone shall be maintained as part of the system's operation and maintenance plan. Undesirable species such as cattail and other exotic or nuisance plants shall be controlled and removed as needed.

**Table 14-2 Native Plant Species Suitable for Littoral Zone Plantings  
or Adjacent to Wet Detention Ponds**

SCIENTIFIC NAME	COMMON NAME	PLANTING ZONE *	FEATURES
<b>TREES SHRUBS AND PALMS</b>			
Acer rubrum	Red maple	1-2	Medium sized tree specimen known for its' attractive brilliant red fall color
Betula nigra	River birch	1	Medium sized tree. Known for its' attractive bark. Prefers moist soils. Is often planted in clumps
Carpinus caroliniana	American hornbeam "Blue Beech"	1	Medium sized tree with attractive bark, and interesting form.
Carya aquatica	Water hickory	1-2	Large tree with large leaves. Fall color (bright yellow)
Cephalanthus occidentalis	Cep halanthus Occidentalis	1-2	Large shrub up to 10 ft tall with white flowers resembling buttons. Buttonbush has a scrubby appearance owing to the dying of leader shoots leaving dead stumps.
Clethra alnifolia	Sweet pepper bush	2	Highlighter, shrub with attractive berries
Crataegus spp.	Haw apple	1	Small tree with white flowers and attractive red fruit
Fraxinus caroliniana	Popash	1-2	Large specimen with attractive foliage and deep furrowed bark
Gordonia lasianthus	Loblolly bay	1-2	Medium to large tree. Large white flowers and attractive foliage
Hypericum spp.	St. Johns Wort	2	Highlighter, shrub
Ilex cassine	Dahoon holly	1	Small tree or shrub with prominent red berries and attractive evergreen foliage
Ilex vomitoria	Yaupon	1	General landscape shrub with attractive red berries.
Illicium floridanum	Florida anise	1	Shrub with attractive aromatic foliage and purple flowers.
Liquidambar styraciflua	Sweetgum	1-2	Medium to large specimen. Attractive unusual shaped foliage and good fall color. Not tolerant of long term inundation
Liriodendron tulipifera	Yellow poplar "Tuliptree"	1	Large specimen; attractive large showy flowers and unusual shaped foliage.
Magnolia virginiana	Sweet bay	1	Medium sized tree with attractive foliage and white flowers.
Myrica cerifera	Wax myrtle	1	Large shrub with attractive aromatic evergreen foliage. Bluish green berries in autumn and

SCIENTIFIC NAME	COMMON NAME	PLANTING ZONE *	FEATURES
			winter are eaten by many birds. Often used in groups for general landscaping and high lighting or accent around ponds.
Nyssa biflora	Blackgum tupelo	1-2	Glossy foliage turning bright red in autumn. Fruit matures in the fall; is consumed by many birds. Flowers are a source for honey.
Ostrya virginiana	Hop hornbean "ironwood"	1	Slow growing small tree with fruit clusters resembling "beer" hops. Trunk looks like sinewy muscle. Nutlets and buds are eaten by wildlife.
Persea palustris	Swamp redbay	1-2	Attractive aromatic glossy green foliage. Bitter fruit is eaten by wildlife. Does not dowell in submerged locations.
Quercus laurifolia	Laurel oak	1	Large tree with attractive nearly evergreen foliage. Acorns eaten by wildlife.
Quercus nigra	Water oak	1	Large deciduous tree with small fine textured foliage. Acorns provide food for wildlife.
Rhapidophyllum hystrix	Needle palm	1	Small to medium sized palm with attractive foliage used for providing tropical highlights. Sharp needles along the trunk lead to its name
Sabal palmetto	Cabbage palm	1	Large palm suited to all areas. Attractive tropical fan shaped foliage.
Taxodium spp.	Bald or Pond Cypress	1-2	Large aquatic deciduous conifer of picturesque form. Preliminary observation shows good survival and rapid growth of either species when used for stormwater enhancement purposes.
<b>FRESHWATER AQUATIC PLANT SPECIES (Herbs, Sedges, Grasses and Ferns)</b>			
Bacopa caroliniana	Lemon bacopa "Water hyssops"	2	Crushed leaves and stems lemon scented. Flowers blue.
Canna flaccida	Golden canna "Canna lily"	2	Very good highlighter. Used on fringe of ponds and lakes. Large showy yellow flowers.
Cladium jamaicense	Saw-grass	1-2	Coarse perennial sedge up to 10 ft. tall. Grows equally well in water or several feet above water level. Long narrow and serrated leaf blades. Provides nesting, protection



SCIENTIFIC NAME	COMMON NAME	PLANTING ZONE *	FEATURES
			and food (seeds) for water fowl and other birds.
Coreopsis nudata	Tickseed	2	Short perennial herb with attractive "daisy shaped" lavender flowers. Prefers shallow water or wet soil at edge of ponds or lakes.
Crinum americanum	Swamp lily	2	Good highlighter at pond fringes. Showy white fragrant flowers. Stems usually less than waist high.
Cyperus odoratus	Umbrella sedge	1-2	Good accent plant usually grown in clumps on edge of ponds. Do well in areas of fluctuating water but also in more upland areas. Its stems are usually less than 3 ft. tall with a conspicuous umbrella shaped foliage and brown seed head
Diodia virginiana	Buttonweed	1-2	Does well in wet soils along the border of ponds. Relatively low growing perennial herb. Small white flowers between leaves and stem. Does not prefer submerged conditions.
Dryopteris ludoviciana	Southern shield Leatherleaf fern	1-2	Suited to wet soils in the zone of fluctuation above the permanent pool
Echinochloa crusgalli	Barnyard grass "wild millet"	1-2	Best suited for edges of ponds and lakes. Steps up to 4 ft tall. Seeds used by waterfowl and songbirds
Eleocharis spp.	Spikerushes	1-2	Suitable for establishing marshes along the coast. Slender, dwarf, and water spikerushes may be submerged. Other varieties grow along the landward edge of ponds. May be grown in clumps or as colonies depending on species
Eriocaulon decangulare	Hat pins	2	Low growing plant with slender spikes. Top is tipped with a small white "button". Provides good contrast with wetland grasses or sedges
Hibiscus spp.	Marsh hibiscus	1-2	Normally used for accent on the edge of ponds. Large flowers 4-8" in diameter.
Hydrocotyle umbellate	Water pennywort	2	Numerous round partly to deeply lobed leaves centrally attached to a stem up to 12 inches long. Grows well on the surface of the water or as a ground cover rooted along the edge of ponds

SCIENTIFIC NAME	COMMON NAME	PLANTING ZONE *	FEATURES
Hymenocallis spp.	Spider lilies	1-2	Provides good ground cover, used for accent on the edge of ponds. Snowy white flowers. Best on wet soils.
Iris hexagona	Anglepod blue flag iris	2	Prefers wet soils at the fringes of lakes and ponds. Average height of 1 ft. with blue flowers. Used for highlighting, planted in groups at the edges of wetlands or ponds.
Iris irginicus	Southern blue flag iris	2	Prefers habitats similar to “angelpod”. More upright grower. Flowers last for several weeks in spring
Juncus effuses	Soft rush	2	Very attractive with pale green hollow stems up to 4 ft tall. Commonly used in large clumps along the edge of lakes or ponds. Seeds used by waterfowl. Does not die back in winter making it a good plant for wet detention ponds where it is planted in clumps
Nebumbo lutea	American lotus	3-4	Attractive, large leafed rooted aquatic. Circular leaves up to 24 inches across with large showy yellow flowers. Planted along the outside of littoral zones in groups spaced about 25 feet apart
Nuphar luteum	Spatterdock	3-4	Water lily wit large oval or heart shaped leaves up to 16 inched long and 10 inches wide. Small, spherically shaped yellow flowers. Roots provide good habitat for shellcrackers.
Nymphaea mexicana	Yellow water lily	3-4	Similar in form and use as other water lilies. Bright yellow flowers.
Nymphoides aquatic	Floating hearts	2-4	Similar to other water lilies. Short thick roots with a cluster of small white flowers
Osmunda cinnamomea	Cinnamon fern	2	Attractive lush foliage best suited for shaded areas internal to or approaching the periphery of cypress or other wooded wetlands
Osmunda regalis	Regal fern	2	Similar habitat as cinnamon fern. May be used to add a “rain forest” like appearance.
Panicum hemitomom	Maidencane	1-2	A grass that does well in dry soils or submerged in water. Forms dense colonies in wet areas and shallow parts of ponds. Aggressive grower.

SCIENTIFIC NAME	COMMON NAME	PLANTING ZONE *	FEATURES
<i>Peltandra virginica</i>	Geen arum “Arrow –arum”		Perennial herb with arrow shaped leaves up to waist high. Blades vary in size up to a foot wide and 1.5 feet long
<i>Polygonum spp.</i>	Smartweek	2	An annual or perennial herb with creeping stems that grows along the ground. Stems have spikes of small pink and white flowers. Seeds used by birds, waterfowl, and small mammals
<i>Pontedaria cordata</i>	Pickerelweed	3	One of the most commonly used and attractive plants in littoral zones. Attractive dark green lance shaped leaves with violet blue flowers.
<i>Sagittaria lancifolia</i>	Arrowhead	3	Another of the more common plants used in littoral zones. Has narrow elliptical lance shaped leaves up to 2 ft in length and 4 inches wide with small white flowers
<i>Sagittaria latifolia</i>	Broadleaf arrowhead	3	Has deeply lobed and arrow shaped leaves up to 1 foot long with small white flowers
<i>Scirpus californicus</i>	Giant bulrush	2-3	Has blunt triangular stems up to 10 ft tall.
<i>Scirpus validus</i>	Soft stem bulrush	2-3	Has cylindrical stems up to 8 feet tall. Attractive brown spikelets with seeds that are eaten by waterfowl and songbirds
<i>Spartina bakeri</i>	Sand cordgrass	1-2	This grass grows in stout and dense clumps. Excellent accent plant on fringes of wet ponds. Has a reddish tinge when flowering.

**\* Planting Zones:**

- 1) + 0.5 feet or more higher than the normal level of the permanent pool.
- 2) +0.5 feet above to -1.0 feet below normal pool.
- 3) - 1.0 feet to - 3.0 feet below the control elevation of the permanent pool.
- 4) - 3.0 feet to - 5.0 feet below normal water level.

**14.4 Floating Wetland Islands or Mats**

Because plants in the aquatic environment store and concentrate nutrients in their tissues, created wetlands have been used extensively for bioremediation. Most of the treatment of nutrient rich water within a wetland occurs in the thin aerobic layer at the surface of the soils within plant communities. This aerobic biofilm is a result of oxygen leakage from the plant roots at the soil-water interface. Floating wetland mats or islands allow growth of plants that have the ability to extract and store nutrients from surface waters. Through the periodic removal of mature

macrophytes from the floating wetland island or mat, accumulated nutrients are prevented from re-entering the aquatic ecosystem at senescence.

**Floating Wetland Design Criteria: (SUBJECT TO CHANGE AS MORE DATA BECOMES AVAILABLE)**

- (a) The area of floating wetland mats shall be at least five percent (5%) of the surface area of the wet detention pond. (What about load reduction if > 5%)
- (b) The floating wetland island or mats shall use a variety of plants that have been documented to have high nutrient uptake in their plant tissues. Some proven plants include *Canna flaccida*, *Juncus effuses*, *Spartina spp.*, *Pontederia cordata*, ADD TO LIST/EDIT
- (c) Floating wetland mats or islands shall be installed and maintained in accordance with permitted design specifications and the manufacturer's instructions.
- (d) Where necessary, exclusion netting shall be used on floating islands or mats to prevent turtles, grass carp, or other animals from eating the plant roots or plants such that they adversely affect the successful growth of the aquatic plants. The applicant may propose alternative mechanisms to minimize eating of plant roots or plants based on an affirmative demonstration, based on manufacturer's recommendations, plans, test results, calculations or other information, that the alternative design is appropriate for the specific site conditions and will meet the above considerations.
- (e) Within 6 months of installation, the floating wetland island or mat shall have at least 90 percent coverage with no more than 10% consisting of exotic or nuisance species.
- (f) Plants on the mats or islands shall be removed and replaced at a minimum on an annual basis. The harvested plant and potting materials shall be removed and disposed of in such a manner that nutrients will not re-enter the stormwater treatment system.

## 15.0 STORMWATER HARVESTING DESIGN CRITERIA

### 15.1 *Description*

Stormwater harvesting uses treated stormwater for beneficial purposes before it is discharged to surface waters, thus reducing the stormwater volume and mass of pollutants discharged. It is most often used with wet detention as part of a BMP treatment train. To properly design a stormwater harvesting system that will result in a predictable average annual mass removal, water budgets are required. A water budget is an accounting of water movement on to, within, and off of an area. The development of a water budget for stormwater harvesting is done to quantify the reduction in offsite discharge for a given period of time. Individual components of storage volume, rate of use, and discharge can be accounted for in the water budget. Calculation of these components requires knowledge of many variables, such as: watershed characteristics, water use volumes and rates, desired percentage of stormwater runoff to be used, maximum volume of stormwater runoff storage, rainfall data, and evaporation data.

The results of long-term simulations of stormwater harvesting ponds over time are presented as Rate-Efficiency-Volume (REV) curves. The REV curves shall be used to design stormwater harvesting systems to improve the nutrient removal effectiveness of wet detention ponds such that these systems meet the performance standards described in **Section 3.1** of this Handbook. Stormwater harvesting curves (REV curves) for the five meteorological zones are provided in **Section 15.7** of this Handbook.

Important assumptions that must be understood when using the REV curves include:

- (a) Net ground water movement into or out of the pond is assumed to be zero over the period of simulation.
- (b) The use rate is kept constant for each month in a year, and presented on the REV curves as an average rate per day and over the equivalent impervious area (EIA).
- (c) The effectiveness results are long term averages based on historical rainfall records. The average values for each year will be different because of annual rainfall volumes and distribution.
- (d) Soil storage in the irrigated area and plant ET are not limiting irrigation application rates.

It should be noted that a supplemental water supply is needed in the dry season when the pond harvested volume is typically depleted. Also, for a design of a stormwater harvesting system which does not meet one of the above assumptions, the applicant can develop a site specific water budget analysis to meet the required performance standard and design criteria.

### 15.2 *Treatment required*

The required nutrient load reduction will be determined by type of water body to which the BMP treatment train that includes stormwater harvesting discharges and the associated performance standard as set forth in **Section 3.1** of this Handbook. The nutrient removal credits associated with stormwater harvesting shall be calculated using the REV Curves and the BMP Treatment Train Equations set forth in **Section 1.3** of this Handbook.

### 15.3 *Equivalent Impervious Area*

When designing stormwater harvesting systems, the runoff characteristics of the watershed must be calculated. The overall runoff coefficient ( $C$ ) for an area composed of different surfaces can be determined by weighting the runoff coefficients for the surfaces with respect to the total areas they encompass, and is based on the rainfall volume used to calculate the maximum volume for use.

$$C = \frac{C_1 A_1 + C_2 A_2 + \dots + C_N A_N}{A_1 + A_2 + \dots + A_N} \quad \text{Equation 15-1}$$

where:  $C_N$  = Runoff coefficient for surface N (see **Appendix B** for values of  $C$ )  
 $A_N$  = Area of surface N

This weighted runoff coefficient ( $C$ ) is termed the effective runoff coefficient and is representative of the entire watershed.

The equivalent impervious area ( $EIA$ ) is equal to the product of the total area of the watershed ( $A$ ) and the effective, or weighted, runoff coefficient ( $C$ ) for the watershed:

$$EIA = C A \quad \text{Equation 15-2}$$

where:  $EIA$  = Equivalent impervious area (acres)  
 $C$  = Effective runoff coefficient for the watershed  
 $A$  = Area of watershed (acres)

The area of the  $EIA$  is defined as the area of a completely impervious watershed that would produce the same volume of runoff as the actual watershed. For example, a 20 acre watershed with an effective runoff coefficient ( $C$ ) of 0.5 would have an  $EIA$  of 10 acres (20 ac x 0.5). If one inch of rain fell on this 10 acre impervious area, the runoff volume would be 10 ac-in (10 ac x 1 in). If the same amount of rain fell on the actual watershed the runoff volume would not change:

$$20 \text{ ac} (1 \text{ in}) (0.5) = 10 \text{ ac-in}$$

The  $EIA$  will be expressed in acres when using this methodology. The use of the  $EIA$  serves to generalize the model so that it can be applied to a watershed of any size and runoff characteristics or as applied to a volume of water used. The product of inches of water used and the area is a volume term.

The  $EIA$  for a watershed shall include the area of the pond when using this methodology.

### 15.4 *Design Criteria*

- (a) The wet detention design criteria in **Section 13.4** of this Handbook, with the exception of 13.4(h) and 13.4 (i), are applicable to stormwater harvesting systems.
- (b) The stormwater harvesting system shall be designed using the **Rate-Efficiency-Volume (REV) Curves** and methodology set forth in **Section 15.7** of this Handbook.
- (c) **Runoff Storage Volume** - The runoff storage volume ( $V$ ) is similar to the “bleeddown volume” or the temporary storage volume in a wet detention pond (**Figure 15.1**). The major

difference between a stormwater harvesting pond and a wet detention pond is the operation of the temporary storage volume. For typical wet detention systems, the bleed-down volume is designed to be discharged to adjacent surface waters using a flow limiting structure. On the other hand, in a stormwater harvesting pond the runoff storage volume is not discharged to adjacent surface waters but is used for some beneficial purpose.

Runoff storage volumes are expressed in units of inches over the *EIA*. The values can be converted to more commonly used units such as acre feet or cubic feet using simple conversions (see the example problems in **Section 15.8** of this Handbook). It should also be noted that in most cases, stormwater harvesting can provide for most of the water needed but the runoff storage volume will not be sufficient to supply all the water needed over a year, especially in dry periods. Thus a back up supply should be planned. A back up supply is one that provides for less than the majority of water needed. If water is taken from the permanent pool of the wet detention system for irrigation, the applicant must demonstrate that the lowering of the permanent pool will not adversely affect surface waters or wetlands.

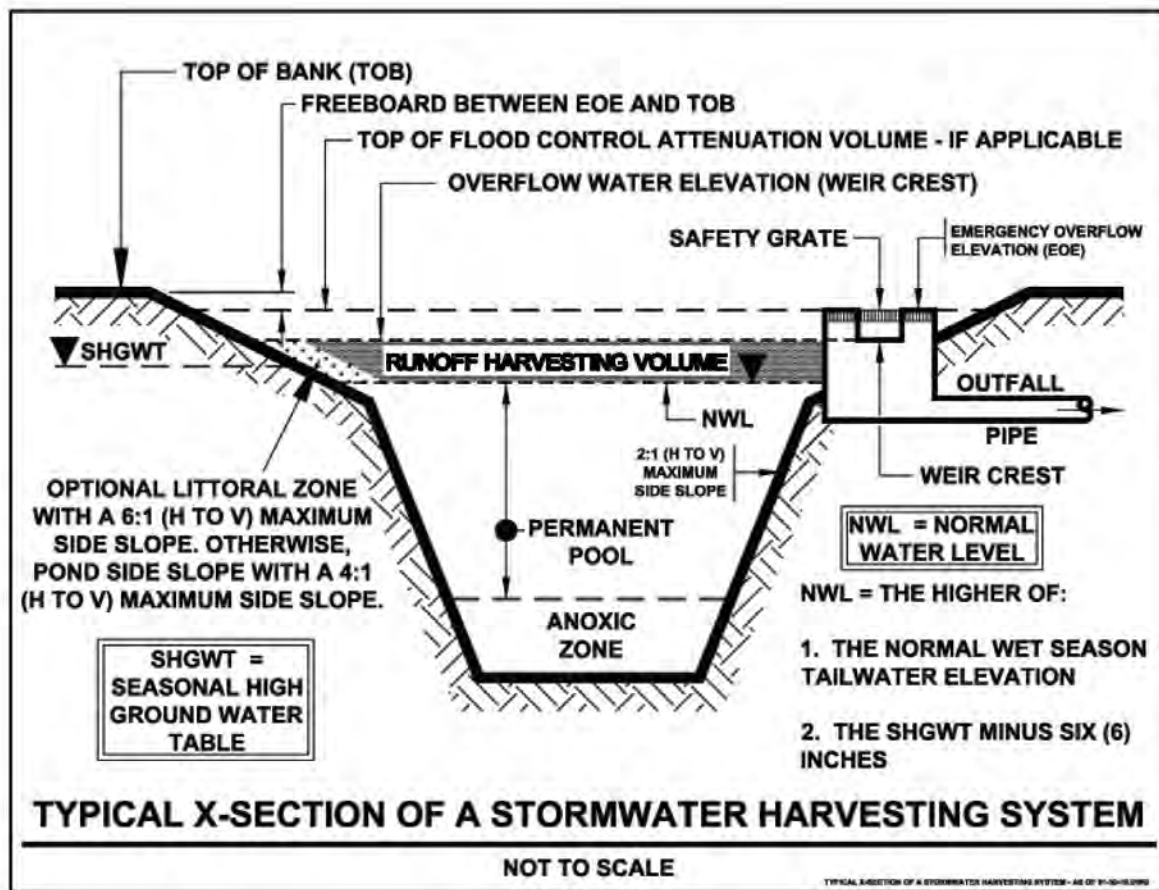
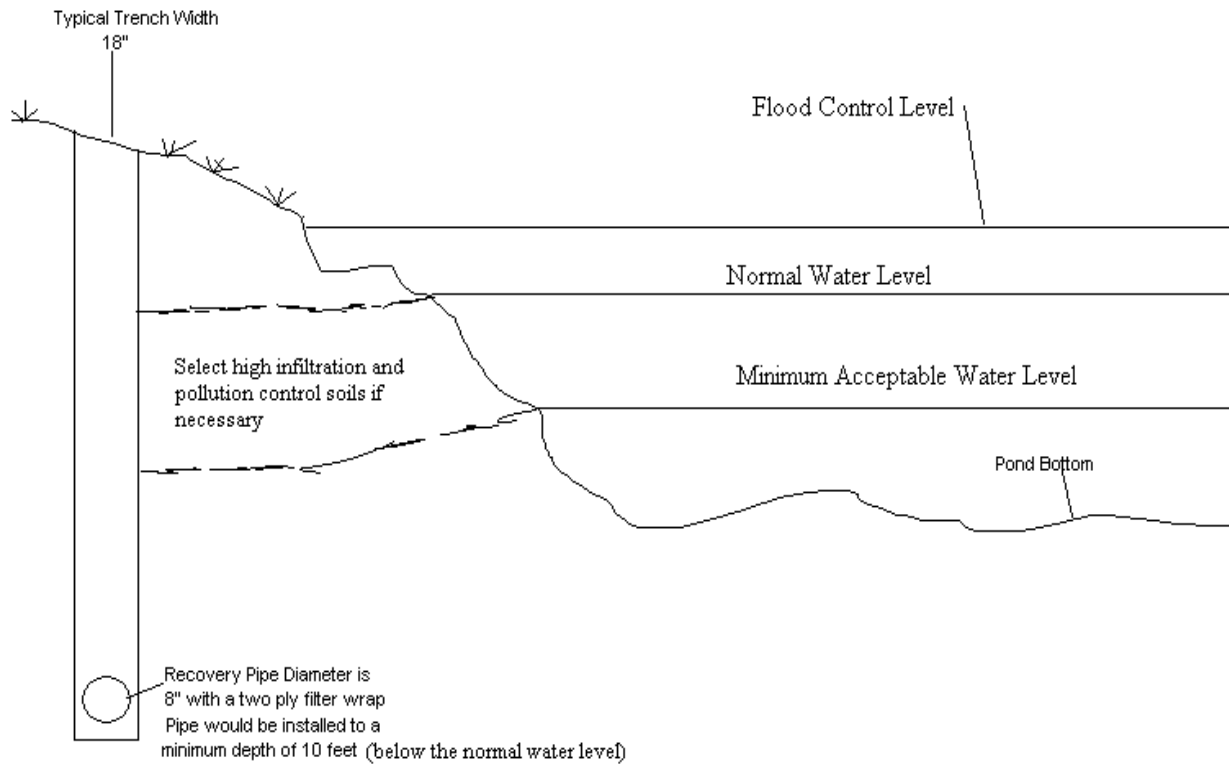

**Figure 15.1 Typical Cross Section of a Stormwater Harvesting System**

- (c) *Uses of Harvested Stormwater* - There are many potential uses for treated stormwater. The most common is for irrigation. Others include vehicle washing, cooling tower make-up, rehydration of wetlands, downstream flow augmentation, fire fighting, agricultural

watering, feed lot cleaning, and toilet flushing. The quality of the harvested stormwater shall be determined by how and where it will be used.

- (d) **Minimum Quality of Harvested Stormwater** – Treated harvested stormwater that is used for irrigation is withdrawn from the stormwater treatment system in a manner that minimizes turbidity, bacteria, pathogens and algal toxins. This can be done by filtering the stormwater to be harvested through a minimum of four (4) feet of native soils or clean sands. This can be accomplished by withdrawing water through a horizontal well configuration located directly adjacent or under the stormwater harvesting pond or by the use of a mechanical sand or disc filter. See **Figures 15.2** and **15.3** for a detailed schematic of approved withdrawal systems. Withdrawal of irrigation water from the stormwater harvesting pond in this manner effectively removes algae, turbidity, and other solids that may clog spray heads and materials that may be considered adverse to human health when converted to an aerosol condition. Acceptable alternatives include in-pipe treatment filtration or a mechanical filter used to remove detained water from ponds. If an applicant proposes to use an alternative to horizontal wells, an affirmative demonstration must be made by the applicant, based on plans, test results, calculations or other information, that the alternative design is appropriate for the specific site conditions, will effectively remove turbidity, pathogens, and algae toxins to prevent adverse impacts.

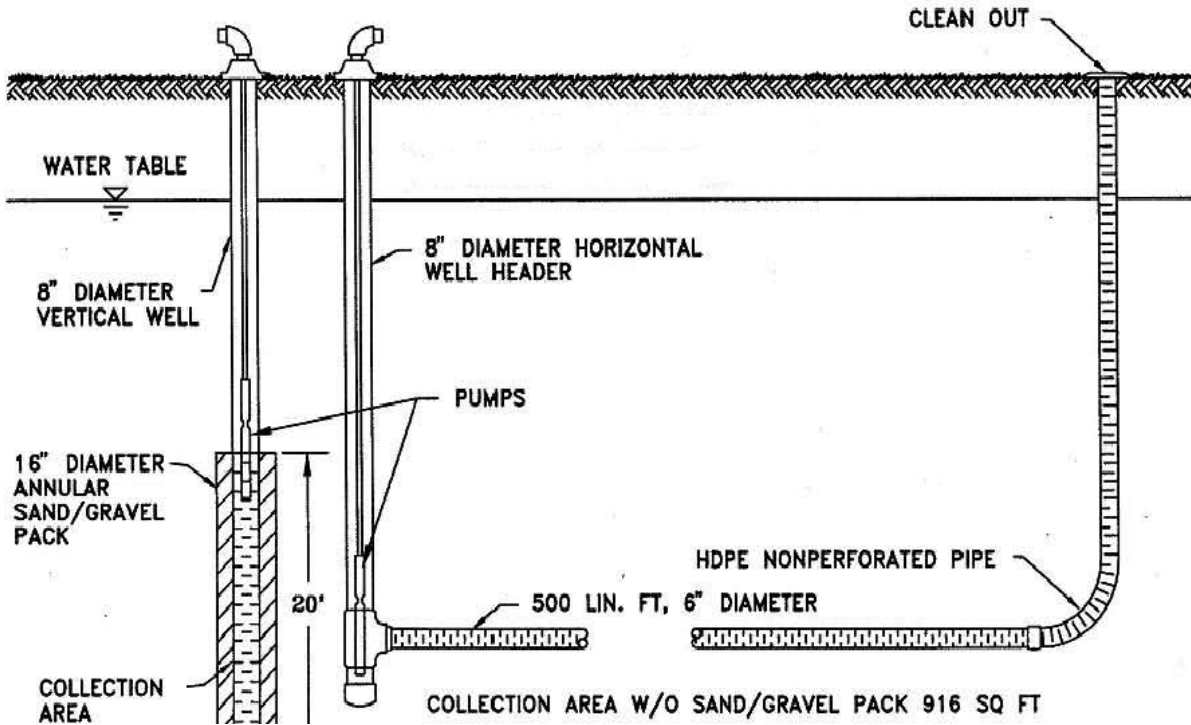

**Figure 15.2 Schematic for a Typical Stormwater Harvesting Pond (from FDOT BD 521-03, Regional Stormwater Facilities, December 2007)**

- (e) **Acceptable Use Rates of Harvested Stormwater** - In addition to water quality considerations, stormwater harvesting systems shall be designed and operated in such a manner to prevent adverse impacts to wetlands or surface waters. A common application of the treated stormwater involves an area to be irrigated. For instance, an apartment complex may irrigate natural vegetation, turf grass, and other landscaped common areas. The average



yearly demand of turf grass irrigation systems in Florida is usually less than one inch per week on the average over a year. The designer shall consult a landscape irrigation specialist for the design of the irrigation system and the recommended irrigation rates. Applicants are advised that a WUP or CUP may be required for stormwater harvesting systems and that the use rates and design shall be consistent with WUP or CUP requirements.



**Figure 15.3 Example Schematic for Stormwater Harvesting Withdrawal System**

- (f) **Rate of Use and Metering of the Harvested Stormwater** - The rate of use (R) is a variable over time and must be recorded. On the REV curves, the rate of use units is expressed as an average inches per day over the EIA. The values can be converted to more practical units such as gallons per day or acre feet per week using simple conversions. The use rate is monitored by a meter or other reporting device. The records of use must be documented in a logbook to demonstrate that the required pollutant load reductions (achieved through reduced volume of discharge) are being met.

### 15.5 Construction requirements

Stormwater harvesting systems typically are used in conjunction with wet detention basins. Therefore, the first step in constructing a stormwater harvesting system is to construct the wet detention basin in compliance with all permitted design specifications. To assure proper construction of the stormwater harvesting system the following construction procedures are required:

- (f) Construct the wet detention basins following the requirements in **Section 13.6** of this Handbook.
- (g) Construct the stormwater harvesting system and the associated irrigation system in accordance with all permitted design specifications and irrigation system design standards.
- (h) Assure that all irrigation components are properly sited and that irrigation spray heads are working properly and not spraying irrigation water onto impervious areas.

## 15.6 *Inspections, Operation and Maintenance*

Maintenance issues associated with stormwater harvesting systems are related to the proper functioning of the horizontal well or filter system and of the pump and irrigation system. Stormwater harvesting systems must be inspected regularly by the operation and maintenance entity to determine if it is operating as designed and permitted. Reports documenting the results of annual inspections shall be filed with the Agency every two years.

### (a) Inspection Items:

- (1) Inspect operation of the stormwater harvesting system to assure that the pump, flow meter, and filter system are operating properly and achieving desired flow volumes.
- (2) Inspect the operation of the stormwater harvesting system to assure proper operation and, with respect to the irrigation system, inspect the pump, timer, distribution lines, and sprinkler heads to assure they are working properly.

### (b) Maintenance Activities As-Needed To Prolong Service:

- (1) Repair any components of the stormwater harvesting system which are not functioning properly and restore proper flow and filtration of stormwater.
- (2) Repair or replace any damaged components of the stormwater harvesting and irrigation system as needed for proper operation.

### (c) Record keeping

The owner/operator of a stormwater harvesting system must keep a maintenance log of activities which is available at any time for inspection or recertification purposes. The log will include records related to the operation of the stormwater harvesting system and the use of the harvested stormwater for irrigation or other approved purposes to demonstrate that the permitted nutrient load reduction is being achieved. A totalizing flow meter to measure the quantity and day/time of pumping and irrigation is required. The maintenance log shall include the following:

- (1) Stormwater volume harvested using a flow meter specifying the day, time, and volume;
- (2) Stormwater volume irrigated or otherwise used using a flow meter specifying the day, time, and volume used;
- (3) Observations of the stormwater harvesting system operation, maintenance, and a list of parts that were replaced;
- (4) Observations of the irrigation system operation, maintenance, and a list of parts that were replaced; and
- (5) Dates on which the stormwater harvesting and irrigation (or other use systems) were inspected and maintenance activities conducted.

## 15.7 *Rate-Efficiency-Volume (REV) Curves*

The REV curves relate the use rate ( $R$ ), the yearly discharge volume average efficiency ( $E$ ), and the runoff storage volume ( $V$ ) of the pond. The curves reflect several use efficiencies and track the appropriate combinations of use rates and runoff storage volumes to attain the effectiveness. Information concerning any two of these three variables is necessary for the determination of the third.

The REV curves are generalized for application to watersheds of any size and runoff coefficient via the *EIA*. The units of both the proposed use rate and runoff storage volume are based on the *EIA*. The proposed use rate is the depth of use multiplied by an area, thus it is a volume term.

An individual REV chart is specific to the five meteorological regions of the State used in this Handbook. The designer shall use the REV chart closest to the project site and within the meteorological zone for design. Each REV chart is composed of REV curves and each curve is specific for an average annual effectiveness. The REV charts for the five meteorological regions are shown on **Figure 15.4 through 15. 8.**

On every REV chart there is a curve for each of the following efficiency levels (in percentage): 20, 30, 40, 50, 60, 70, 80, and 90. Extrapolation between effectiveness lines for a given runoff storage volume on a linear basis is considered reasonable. The range of the curves is restricted by practical applicability and the limits of the simulation variables. The boundaries of the daily data simulation are such that the use rate is limited to no more than 0.50 inches per day over the *EIA* and the runoff storage volumes are no less than 0.25 inches and no greater than 6 inches over the *EIA*. There are marginal returns on efficiencies beyond some maximum runoff storage volume, thus the curves are only produced where there is a marginal change in effectiveness that is within the measurement accuracy. As an example, at low average annual effectiveness, say 20%, the effectiveness does not change with added runoff storage volume greater than about 2.5 inches.

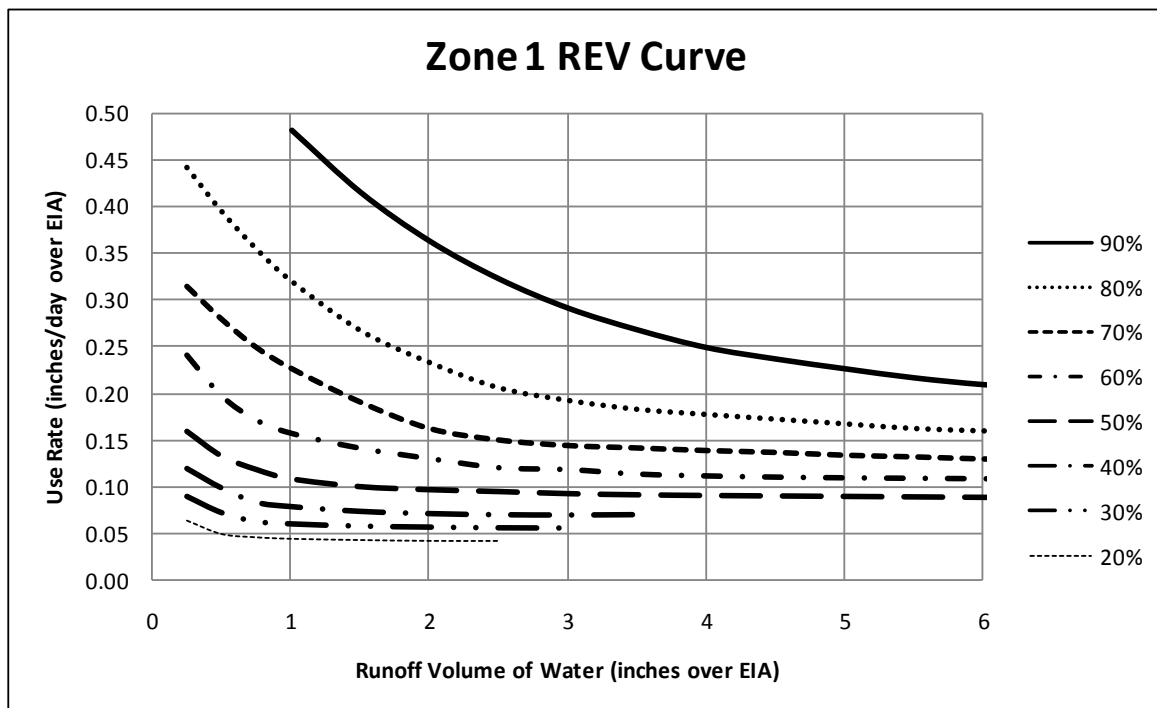

**Figure 15.4 REV Curve for Meteorological Region 1**

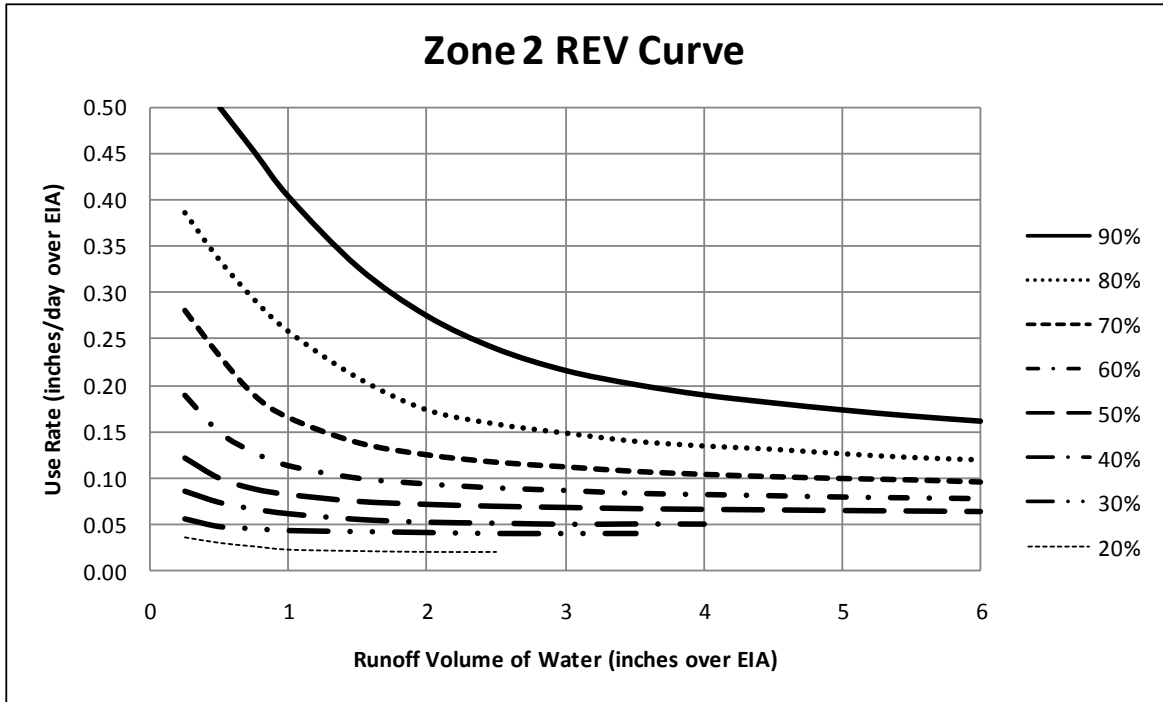

Figure 15.5 REV Curve for Meteorological Region 2

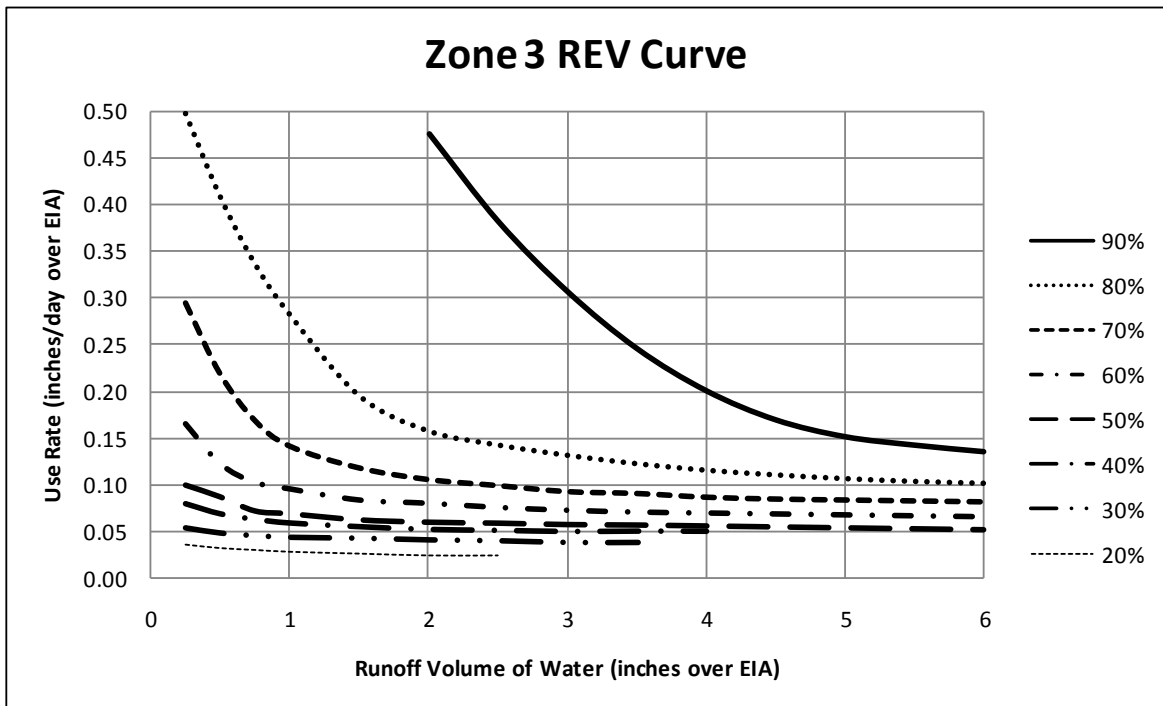

Figure 15.6 REV Curve for Meteorological Region 3

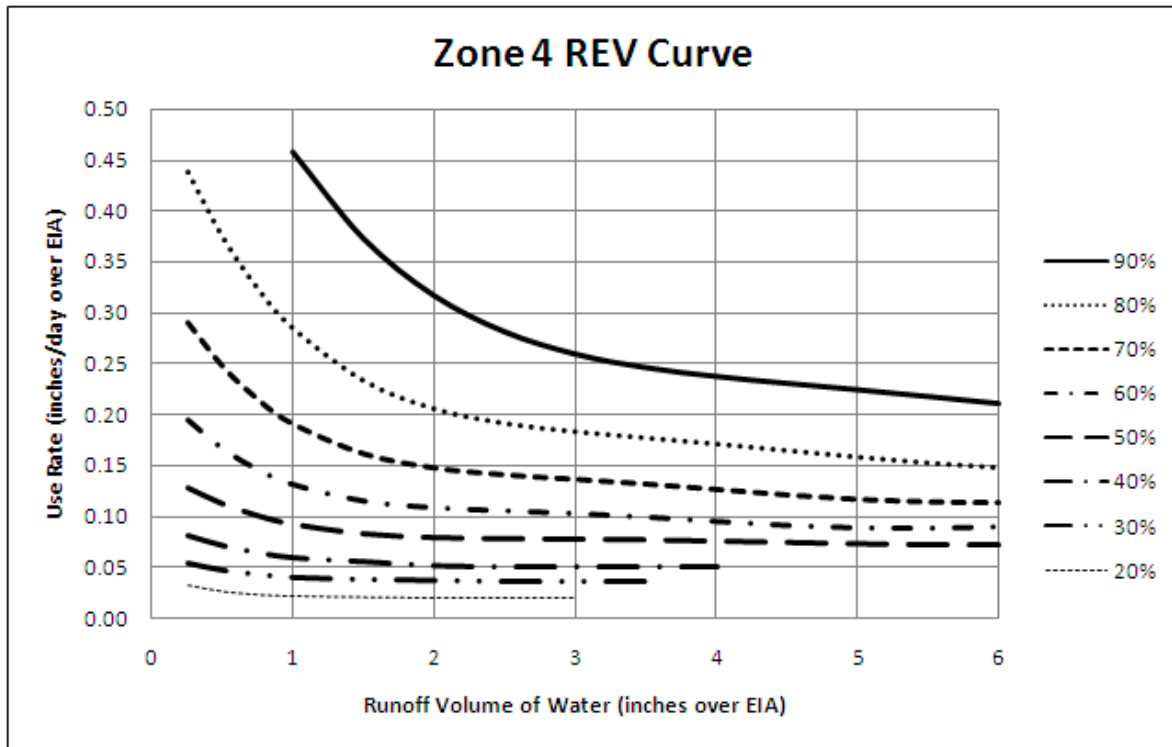

Figure 15.7 REV Curve for Meteorological Region 4

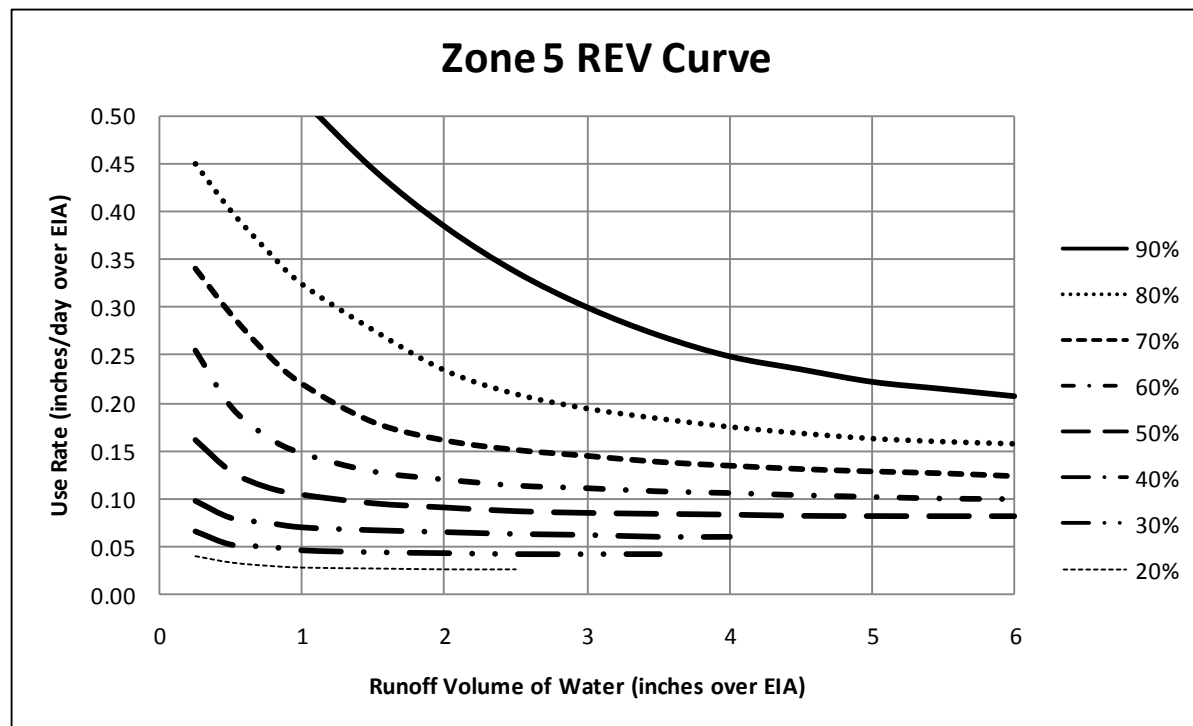

Figure 15.8 REV Curve for Meteorological Region 5

## **16 DESIGN CRITERIA FOR WETLAND STORMWATER TREATMENT TRAINS**

**ISSUE: We have proposed this BMP as a retention practice because of the high variability in the literature with respect to TN and TP removal by various types of wetland systems. We are seeking input on this approach. We also are seeking input and data on the urban stormwater TN and TP removal efficiencies for various types of wetlands (we are not seeking wastewater data).**

### **16.1 Description**

Florida statutes encourage the use of wetlands for stormwater treatment. Sect. 373.414(3), F.S. states: *"It is the intent of the Legislature to provide for the use of certain wetlands as a natural means of stormwater management and to incorporate these waters into comprehensive stormwater management when such use is compatible with the ecological characteristics of such waters and with sound resource management. To accomplish this, the governing board or the department is authorized to establish by rule performance standards for the issuance of permits for the use of certain wetlands for stormwater management. The compliance with such standards creates a presumption that the discharge from the stormwater management system meets state water quality standards."*

The goal of the criteria in this section is to allow the integration of wetlands into a stormwater BMP treatment train system when such use is compatible with the existing ecological characteristics of the wetlands proposed to be used.

### **16.2 Types of Wetlands that May Be Used for Stormwater Treatment**

The only wetlands which may be used for stormwater treatment are those which are:

- (1) Isolated and wholly owned by one person; or
- (2) Are connected to other surface waters in a manner that could be hydrologically severed to make the wetland isolated and wholly owned by one person; and
- (3) Are not included within the geographic boundaries of the area described in Paragraph 403.031(13)(a), Florida Statutes.

### **16.3 Required Treatment**

The Required Treatment Volume (RTV) necessary to achieve the required treatment efficiency shall be routed to the wetland stormwater treatment train and percolated into the ground. The required nutrient load reduction will be determined by type of water body to which the stormwater system discharges and the associated performance standard as set forth in **Section 3.1** of this Handbook. The RTV needed to achieve the necessary efficiencies shall be determined based on a project's percentage of directly connected impervious area (DCIA) and the weighted curve number for non-DCIA areas. **Appendix D** provides dry retention depths (inches of runoff over the drainage area) in order to achieve 85 percent removals for the various meteorological regions. For post=pre calculations, **Appendix F** provides performance efficiencies for dry retention runoff volumes for the various meteorological regions.

### **16.4 Nutrient Treatment Credit**

Treatment credit for stormwater wetland treatment trains shall be based on the BMP treatment train equations. The nutrient removal treatment credit shall be determined based on either:

- (1) By calculating the total volume of runoff that is retained within the wetland and not discharged; or,

- (2) Submittals by the applicant of plans, Florida monitoring data, test results, calculations, and other information related to the pollutant removal efficiency of stormwater by wetlands to support the nutrient removal efficiency of the wetland which the applicant proposes to use in the BMP treatment train calculations.

### **16.5 Design Criteria and Other Requirements for Incorporating Wetlands into Stormwater BMP Treatment Trains**

When a wetland is incorporated into a stormwater BMP treatment train for purposes of providing stormwater treatment, the applicant must provide reasonable assurance that wetland characteristics and functions, including the value of functions provided to fish and wildlife and listed species will not be adversely impacted by the proposed activity.

A showing by the applicant that the wetland stormwater BMP treatment train design complies with the design criteria listed below shall create a presumption that the minimum level of treatment is met:

- (a) An applicant proposing to incorporate a wetland into a stormwater BMP treatment train is encouraged to schedule and attend a preapplication meeting with the Agency to discuss the conceptual plan and the data and analysis that will be required in the permit application.
- (b) The wetland component of the BMP treatment train shall be designed as an off-line system and flood attenuation volumes shall not be routed through the wetland.
- (c) Pretreatment of runoff discharged into the wetland will be required using the BMP treatment train. The pretreatment must assure that sediment, oils and greases are prevented from runoff entering the wetland and that nutrient loads entering the wetlands do not exceed levels that would adversely impact the wetland and prevent the overall BMP treatment train from meeting the required nutrient load reduction set by the applicable performance standard in **Section 3.1** of this Handbook.
- (d) Erosion and sediment controls shall be used during construction and operation of the system to minimize sedimentation of the wetland used for stormwater treatment. The sediment control mechanism shall be built in the uplands and be of sufficient size and design to minimize resuspension and discharge of collected sediments into the wetland and to allow for recurring maintenance removal of sediments without adverse impact to the wetland.
- (e) Systems which receive stormwater from areas which are a potential source of oil and grease contamination shall include a baffle, skimmer, grease trap or other mechanism to minimize the amounts of oils and greases entering the wetland used for stormwater treatment.
- (f) Inlet structures shall be designed to dissipate the energy of runoff entering the wetland to prevent erosion within the wetland
- (g) Stormwater shall be discharged into the wetland used for treatment so as to minimize the channelized flow of stormwater and maximize sheet flow through the wetlands. Methods can include design features such as multiple inflows, bubble-up structures, or overland flow methods.
- (h) For unimpacted wetlands, which are defined as those wetlands where normal range of water level fluctuations has not been artificially altered, the addition of the stormwater treatment volume to the wetlands shall not adversely affect the wetland by disrupting the normal range of water level fluctuation or the duration of impounding water in the wetland as it existed prior to construction of the wetlands stormwater BMP treatment train system.

Normal range of water level fluctuation will be defined as the maintenance of the fluctuating water surface changes between the normal low water and the normal high water of the wetland system so as to prevent the desiccation or over impoundment of the wetland. Upland detention or retention will be necessary to attenuate peak flows and meet the water level fluctuations specified above.

- (i) For impacted wetlands, which are defined as those wetlands where the normal range of water level fluctuations has been artificially altered, the Agency shall establish an acceptable range of water level fluctuation and duration of impounding water based on historical information related to the previous size and nature of the wetlands, if available. If such information is not available, the range of water level fluctuation and duration of impounding water shall be derived from sound scientific principles or from analysis of other natural wetland systems in the vicinity.
- (j) The applicant shall obtain accurate topographic information using an appropriate registered professional for the entire wetland to be incorporated into the BMP treatment train. This data will be used to determine the storage volume and acceptable water levels within the wetland.
- (k) The applicant shall perform predevelopment and post-development continuous simulation hydrologic modeling with an appropriate model that incorporates both surface and ground water hydrology to demonstrate that the above requirements are met for the required treatment volume and provide reasonable assurance that the wetland hydro-regime will not be altered in a manner that adversely affects wetland functions. At least 10 years of representative rainfall and evapotranspiration data shall be used in the modeling. The ground water data used in the continuous simulation must be representative of the site's conditions and will be considered in evaluating adverse effects of wetland functions.
- (l) If the applicant proposes to dredge or fill in the wetland used for stormwater treatment, the Agency in its review of the permit application shall evaluate the adverse effects of the dredging or filling on the wetland and the treatment capability of the wetland.
- (m) If the wetland to be incorporated into a wetland stormwater treatment train is connected to other surface waters, the applicant shall demonstrate that the treatment wetland will be hydrologically severed from other surface waters as a part of the proposed activity.

#### **16.6 Construction requirements**

#### **16.7 Inspection, Operation, and Maintenance**



## 17.0 UNDERDRAIN FILTRATION SYSTEM DESIGN CRITERIA

**ISSUE:** This is an interim BMP since no data currently is available on the nutrient removal effectiveness of this BMP. The DEP-WMD stormwater team is identifying sites for monitoring and will be monitoring underdrain systems during the next several months to obtain data on nutrient removal effectiveness. The DEP-WMD stormwater team also is seeking input on alternative BMPs for sites on HSG C and D soils that are effective in removing nutrients.

### 17.1 Description

Stormwater underdrain systems consist of a dry basin underlain with perforated drainage pipe which collects and conveys stormwater following percolation from the basin through suitable soil. Underdrain systems are an option for the applicant where high water table conditions dictate that recovery of the stormwater treatment volume cannot be achieved by natural percolation (i.e., retention systems) and suitable outfall conditions exist to convey flows from the underdrain system to receiving waters. Schematics of a typical underdrain system are shown in **Figures 17.1** and **17.2**.

Underdrain systems are intended to both control the water table elevation over the entire area of the treatment basin, and provide for the drawdown of the treatment volume. Underdrains are used where the soil permeability is adequate to recover the treatment volume since a component of on-site soils overlay the perforated drainage pipes.

There are several design and performance criteria which must be met in order for an underdrain system to meet the rule requirements. The underdrain rule criteria are described below.

### 17.2 Required Treatment Volume

The required nutrient load reduction will be determined by type of water body to which the stormwater system discharges and the associated performance standard as set forth in **Section 3.1** of this Handbook. The treatment volume necessary to achieve the required treatment efficiency shall be infiltrated through the underlying soils and adsorption media to the underdrain system and discharged into the down gradient BMPs or receiving waters. .

### 17.3 Design Criteria

(a) **Recovery Time** - The system shall be designed to provide for the drawdown of the appropriate treatment volume within 72 hours following a storm event. The treatment volume is recovered by filtration and percolation through the soil and adsorption media with subsequent discharge through the underdrain pipes. A recovery analysis is required that accounts for drawdown within the system and an example is provided in **Section 29** of this Handbook.

The pipe system configuration (e.g., pipe size, depth, pipe spacing, and pipe inflow capacity) of the underdrain system must be designed to achieve the recovery time requirement. Under-design of the system will result in reduced hydraulic capacity. This, in turn, will result in a reduction in storage between subsequent rainfall events and an associated decrease in the annual average volume of stormwater treated resulting in a reduction of pollutant removal.

The applicant shall ensure that the discharge pipe invert elevations address the design tailwater condition. An inappropriate estimate of the tailwater elevation will result in system failure due to the inability to recover the treatment volume during periods of high tailwater.

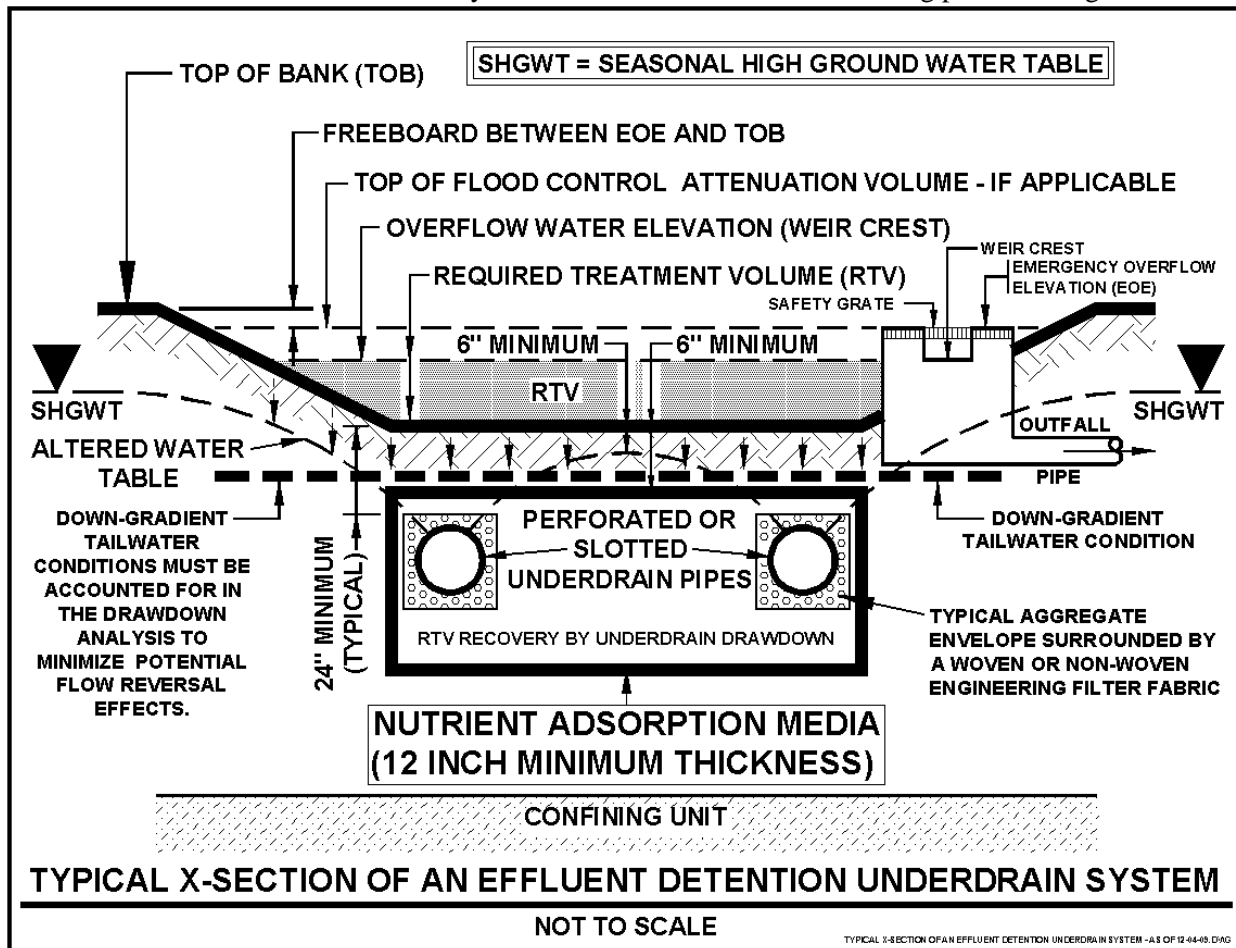

Figure 17.1 Cross-section of Underdrain System (N.T.S.)

- (b) **Underdrain Media** - Underdrain systems assist in volume recovery where the native soil has a good capacity for percolation, but where high water table conditions generally prevent the infiltration of the treatment volume through the soil profile. To provide proper treatment of the runoff, at least **12 inches** of adsorption media is required between the bottom of the basin storing the treatment volume and the outside of the underdrain pipes (and gravel envelope as applicable). The media must provide adsorption for phosphorus and an environment suitable for anoxic conditions that will foster the denitrification process.

To remove both total nitrogen and total phosphorus, all of the following adsorption media criteria shall be met:

- Greater than 15% but less than 30% of the particles passing the #200 sieve.
- At least 12 inches in thickness.
- Water holding capacity is at least 35%, and as measured by porosity.

- Permeability is greater than 0.03 inches per hour but less than 0.25 inch per hour. If the filter is being used to remove phosphorus only, the permeability rate can be increased up to a maximum of three inches (3") per hour.
  - Organic content is no more than 5% by volume.
  - pH is between 6.5 and 8.0.
  - Sorption capacity exceeds 0.005 mg OP/mg media.
- (d) **Aggregate Envelope and Filter Fabric** - To prevent the surrounding soil from moving into and clogging the underdrain system, underdrain pipes shall be enclosed within a 6" (six inch) minimum coarse aggregate envelope surrounded by woven or nonwoven filter fabric with a permeability greater than the surrounding soils.
- (e) **Inspection and Cleanout Ports** - To facilitate maintenance of the underdrain system, capped and sealed inspection and cleanout ports which extend to the surface of the ground shall be provided, at a minimum, at the following locations for each drainage pipe:
- The terminus; and
  - At every 400 feet or every bend of 45 or more degrees, whichever is shorter.
- (f) **Basin Stabilization** - The underdrain basin sides and bottom shall be stabilized with permanent vegetative cover, some other pervious material, or other methods acceptable to the Agency that will prevent erosion and sedimentation.
- (g) **Elevation of Underdrains** – Underdrain systems have the potential to lower ground water elevations and, if not designed properly, may adversely affect water levels and conflict with other environmental resource permitting criteria not directly related to water quality. The depths of underdrains shall minimize the drawdown of the ground water table elevation and not adversely affect water resources.

When setting the elevation of the underdrains, applicants are advised to consider the following potential effects of their design of the underdrain system. While consideration of these effects is not required by this rule, failure to take them into account may cause conflicts with other Agency rules.

- The effect on existing water table elevations in existing wellfield cones of depression;
  - The effect on water table elevations needed to preserve environmental values at the project site;
  - The effect on minimum flows or levels of surface waters established pursuant to Section 373.042, F.S.
  - The effect of lowering water table elevations such that the existing water use rights of others will not be adversely affected;
  - The effect on ground water recharge characteristics of the project site;
  - The effect on ground water levels needed to protect wetlands and surface waters;
  - The effect on surrounding land, potable water supply wells, project control elevations and water tables;
  - Creating conflicts with water use permitting requirements or water use restrictions;
- (h) **Ground water nutrient loads** - If the invert of the underdrain system is located more than two (2) feet below the SHGWT, nutrient loads from baseflows must be accounted for in the loading calculations and the nutrient load reduction calculations.

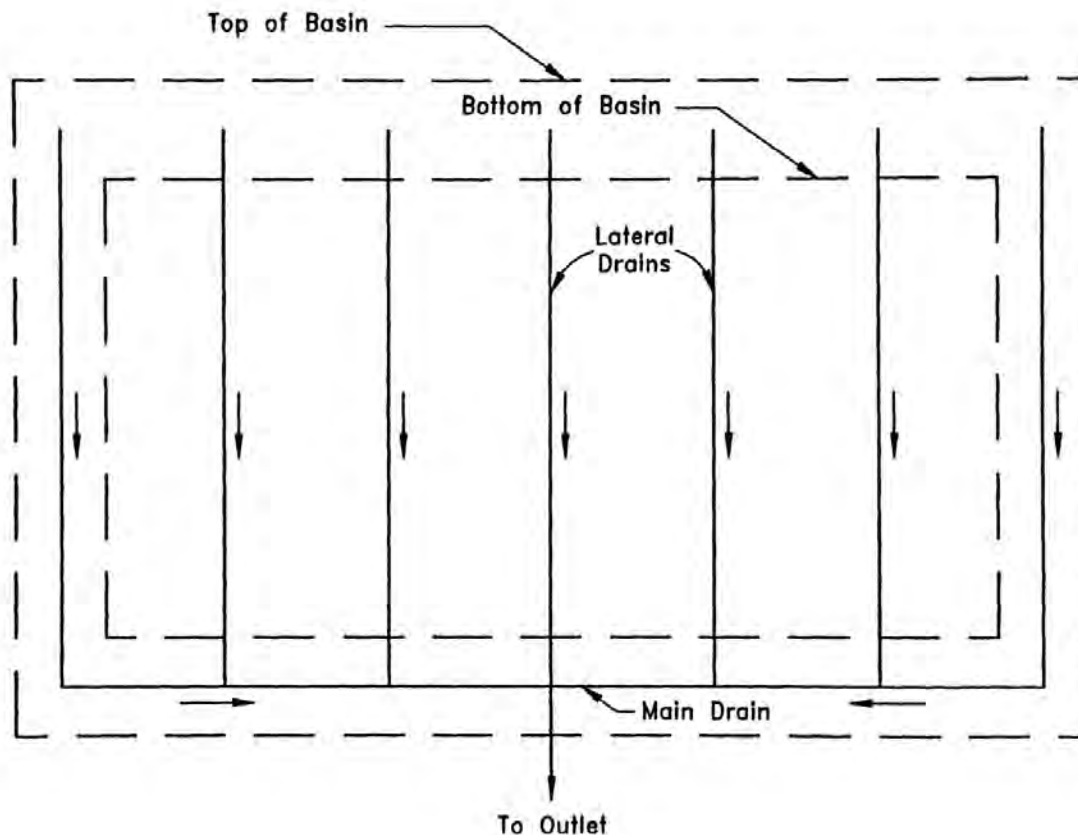

**Figure 17.2 Top View of Underdrain System (N.T.S.)**

#### **17.4 Required Site Information**

Successful design of underdrain system depends heavily upon conditions at the site, especially information about the soil, geology, and water table conditions. Specific data and analyses required for the design of an underdrain system are set forth in **Section 21**.

#### **17.5 Construction requirements**

During construction, every effort should be made to limit compaction of soil and reduce infiltration capacity of the system which will supplement the filtration provided by the system.

- (a) The location and dimensions of the underdrain filtration system shall be verified onsite prior to its construction. All design requirements including dimensions and distances to foundations, septic systems, wells, etc., need to be verified.
- (b) When excavating for the underdrains, the materials removed shall be placed a sufficient distance from the sides of the excavated area to minimize the risk of sidewall cave-ins and prevent the material from re-entering the underdrain trench.

- (c) The underdrain trench bottom and side walls shall be inspected for materials that could puncture or tear the filter fabric, such as tree roots, and assure they are not present.
- (d) The aggregate material shall be inspected prior to placement to ensure it meets size specifications and is washed to minimize fines and debris.
- (e) The adsorption media shall be checked to assure that it meets permitted specifications and placed into the bottom of the underdrain trench.
- (f) Inflows to the underdrain system shall be temporarily blocked until the contributing drainage area is stabilized to prevent sediment from entering and clogging the underdrains.
- (g) An applicant may propose alternative construction procedures to assure that the constructed underdrain filtration system meets permit requirements provided they are acceptable and approved by the Agency.

### **17.6 *Inspections, Operation and Maintenance***

(a) Inspection Items:

- (1) Monitor facility for sediment accumulation in the underdrain pipe and storage volume recovery (i.e., drawdown capacity). Observation wells and inspection ports should be checked following 3 days minimum dry weather. Failure to recover the design treatment volume level within 72 hours indicates possible binding of soil in the underdrain trench walls and/or clogging of geotextile wrap with fine solids. Reductions in storage volume due to sediment in the distribution pipe, also reduces efficiency. Major maintenance (total rehabilitation) is required to remove accumulated sediment in most cases or to restore recovery rate when minor measures are no longer effective or cannot be performed due to design configuration.
- (2) Inspect appurtenances such as sedimentation and oil and grit separation traps or catch basins as well as diversion devices and overflow weirs when used. Diversion facilities and overflow weirs should be free of debris and ready for service. Sedimentation and oil/grit separators should be scheduled for cleaning when sediment depth approaches cleanout level. Cleanout levels should be established not less than 1 foot below the invert elevation of the chamber.

(b) As-Needed To Prolong Service:

- (1) Remove sediment from sediment or oil/grease traps, catch basin inlets, manholes, and other appurtenant structures and dispose of properly.
- (2) Remove debris from the outfall or “Smart Box” (diversion device in the case of off-line facilities).
- (3) Removal of sediment and cleaning of underdrain trench system. This process normally involves facilities with large pipes. Cleanout may be performed by suction hose and tank truck and/or by high-pressure jet washing.

(c) As-Needed To Maintain 72-Hour Exfiltration Rate:

- (1) Periodic clean-out or rehabilitation of the system to remove any accumulated trash, sediment and other inflow debris and remediate any clogging of perforated pipes.
- (2) Total replacement of the system. In some cases the system may not be able to be rehabilitated sufficiently to restore the permitted recovery time. In these cases, complete replacement of the system may be necessary. The applicant shall provide an estimate of the expected life expectancy of the underdrain filtration system and an estimate of the cost to replace it if it fails.

## 18.0 LOW IMPACT DESIGN BMPS – DESIGN AND LOAD REDUCTION CREDITS

To achieve the level of nutrient treatment required for the protection of Florida's surface and ground waters, greater emphasis must be placed on nonstructural BMPs, the first car in the BMP Treatment Train. When applied early in the design process, low impact design techniques can reduce stormwater volume and pollutants generated from development sites. The use of low impact design BMPs can reduce stormwater treatment and management BMP size requirements. Stormwater nutrient load reduction credits for low impact design BMPs are directly related to the amount of stormwater volume or pollutant load that is prevented. Not all credits will be available for each site, and certain site-specific conditions must be met to receive each credit. These minimum conditions include site factors such as maximum flow length or contributing area that avoid situations that could lead to runoff concentration and erosion. Stormwater load reduction credits associated with low impact design BMPs do not relieve designers from the normal standard of engineering practice of safe conveyance and stormwater management design.

Low impact design BMPs that are eligible for stormwater nutrient load reduction credits include:

- Natural Area Conservation
- Site Reforestation
- Disconnecting Directly Connected Impervious Areas
- Florida-friendly landscaping
- Rural subdivisions

### Low Impact Design BMPs

#### 18.1 *Natural Area Conservation Credit*

Natural area conservation protects natural resources and environmental features that help maintain the undeveloped hydrology of a site by reducing runoff, promoting infiltration and preventing soil erosion. The undisturbed soils and native vegetation of conservation areas promote rainfall interception and storage, infiltration, runoff filtering and direct uptake of pollutants. Natural areas are eligible for stormwater credit if they remain undisturbed during construction and are protected by a permanent conservation easement prescribing allowable uses and activities on the parcel and preventing future development. Examples of conservation areas include any areas of undisturbed vegetation preserved at the development site, such as forests, floodplains and riparian areas, steep slopes, and stream, wetland and shoreline buffers.

#### Calculation of Stormwater Treatment Credit

Natural areas that are placed into conservation shall be excluded from the runoff calculations used to determine the volume of stormwater that must be treated or to calculate pre- and post-development nutrient loads.

#### Conditions for Credit

Proposed conservation areas shall meet all of the conditions outlined below to be eligible for credit:

- The minimum combined area of all natural areas conserved at the site must exceed one acre.
- No disturbance may occur in the conservation area during or after construction (i.e., no clearing or grading except for restoration operations or removal of vegetation unless provided for within the conservation easement).

- The limits of disturbance around each conservation area shall be clearly shown on all construction or permit drawings.
- A long-term vegetation management plan must be prepared to maintain the conservation area in a natural vegetative condition. Managed turf is not considered an acceptable form of vegetation management, and only the passive recreational areas of dedicated parkland are eligible for the credit (e.g., ball fields and golf courses are not eligible).
- The conservation area must be protected by a perpetual easement which is filed in the public records prior to beginning construction.
- The credit cannot be granted for natural areas already protected by existing federal, state, local law, or existing conservation easement.

## 18.2 *Site Reforestation Credit*

Site reforestation involves planting trees on existing turf or barren ground at a development site with the explicit goal of establishing a mature forest canopy that will intercept rainfall and maximize infiltration. Reforested or restored sites that are protected and maintained under a perpetual conservation easement will be eligible for this load reduction credit.

Reforestation is accomplished through active replanting or natural regeneration of forest cover. A range of research has demonstrated the runoff reduction benefits associated with forest cover compared to turf cover. The runoff benefits include greater infiltration of stormwater, reduced soil erosion, and removal of stormwater pollutants. Forest soils actively promote greater infiltration rates through surface organic matter and macropores created by tree roots. Forests also intercept rainfall in their canopy, reducing the amount of rain that reaches the ground. Evapotranspiration by trees increases potential water storage in the soil.

### Calculation of Stormwater Treatment Credit

Natural areas that are placed into conservation shall be excluded from the runoff calculations used to determine the volume of stormwater that must be treated or to calculate pre- and post-development nutrient loads.

### Conditions for Credit

A proposed reforestation project shall meet all of the conditions outlined below to qualify for stormwater treatment credit:

- The minimum contiguous area of reforestation shall be greater than 20,000 square feet (i.e., no credit is granted for planting of individual trees).
- A long-term vegetation management plan must be prepared and filed as part of the permit application to maintain the conservation area in a natural forest condition.
- The conservation area must be protected by a perpetual conservation easement recorded in the public record pursuant to Section 704.06, F.S.
- The method used for reforestation must achieve 75% forest canopy cover within ten years.
- The planting plan must be approved by the Agency, including any special site preparation needs.



- A financial responsibility mechanism, equal to 110% of the planting costs, which lasts for at least three growing seasons to ensure adequate survival and growth of the plants shall be issued to the Agency.
- The credit cannot be granted for natural areas already protected by existing federal, state, or local law.

### ***18.3 Disconnection of Impervious Area Credit***

Directly connected impervious areas allow runoff to be conveyed without interception by permeable areas that allow for infiltration and treatment. Disconnecting impervious areas from roofs, small parking lots, courtyards, driveways, sidewalks and other impervious surfaces allows runoff to flow onto adjacent pervious areas where it is filtered or infiltrated. Disconnection of rooftops offers an excellent opportunity to spread rooftop runoff over lawns and other pervious areas where it can be filtered and infiltrated. Downspout disconnection can infiltrate runoff, reduce runoff velocity, and remove pollutants. Alternately, downspouts can be directed to a rain barrel, dry well, rain garden or landscaped infiltration area. In most cases, the site is graded to divert sheet flow into a swale, infiltration basin, vegetated natural buffer or pervious area for treatment. Disconnecting small areas of impervious cover from the storm drain system can greatly reduce the total volume and rate of stormwater runoff. Credits for surface disconnection are subject to numerous restrictions concerning the length, slope, soil characteristics of the pervious area which are designed to prevent any reconnection of runoff with the storm drain system. In some cases, minor grading of the site may be needed to promote overland flow and vegetative filtering.

#### Stormwater Treatment Credit

The total disconnected impervious area is moved from the Directly Connected Impervious Area calculations of stormwater treatment volume to the non-DCIA area when computing the stormwater treatment volume.

#### Conditions for Credit

For the purposes of the stormwater treatment rule, impervious area is disconnected if all of the following conditions apply for the overland flow of stormwater:

- The contributing impervious area is not more than 50% larger than the overland flow area.
- The overland flow distance is 25 feet or greater unless the applicant affirmatively demonstrates based on plans, test results, calculations or other information that that a lesser distance will provide for stormwater infiltration and reduction of volume;

In determining the non-DCIA curve number the applicant shall consider the following factors:

- The topography allows for the establishment of flat to moderate (0.5%-5%) transverse slopes; and
- Flow velocity is limited to 0.15 feet/second during the 5-year recurrence interval rainfall intensity.

Soil amendments may be needed to restore porosity of compacted pervious areas. Soil amendments refer to tilling, composting, or other amendments to urban soils to recover soil porosity, increase water holding capacity, and reduce runoff. Soils in many urban areas are highly compacted as a result of prior grading, construction traffic and ongoing soil disturbance. Amendments recover soil porosity by incorporating compost, top soil, and other soil conditioners to improve the hydrologic properties of lawns or landscaped areas. Soil amendments are often needed to obtain disconnection credits on sites with compacted or poorly infiltrating soils.

## 18.4 *Florida-friendly Landscaping Credit*

Our yards, landscapes, and neighborhoods are channels to our waterways. The yard is the first line of defense for preserving Florida's vulnerable and limited water resources. The health of Florida's estuaries, rivers, lakes, springs and aquifers depends partly on how our landscapes and yards are designed and maintained. Rain that falls on yards, roads and parking lots can wash into waterways or leach into ground water, carrying pollutants—including fertilizers, pesticides, animal waste, soil and petroleum products. Improperly applied fertilizers and pesticides from residential areas pose a serious threat to the health of Florida's surface and ground waters.

For decades, Florida landscaping has been portrayed as picture postcards of lavish resorts, tourist destinations and tropical gardens. But the pictures of natural Florida are quite different. The Florida Natural Areas Inventory identifies 82 different natural ecological communities in Florida, from wetlands to xeric uplands. Unfortunately, much of the state's original rich diversity has been replaced with impervious surfaces, such as asphalt and concrete, and housing developments with standardized yards that bear little resemblance to native Florida. Expanses of high-maintenance lawns have formed the dominant landscape in most of our communities for years, but that is changing. Florida-friendly landscaping and fertilizers are now being promoted as nonstructural BMP to reduce the need for fertilizers, pesticides, and irrigation through the Florida Yards and Neighborhoods and the Green Industry BMP program.

The ideal Florida-friendly Yard—the smart way to grow—should boast natural beauty that reflects the native landscapes of our state. But this beauty must be created and sustained by environmentally safe landscape practices. What are some of those practices? This integrated approach to landscaping emphasizes nine interrelated principles:

- **Right plant, right place**
- **Water efficiently**
- **Fertilize appropriately**
- **Mulch**
- **Attract wildlife**
- **Manage yard pests responsibly**
- **Recycle yard waste**
- **Reduce stormwater runoff**
- **Protect the waterfront**

In addition to Florida-friendly landscape design, proper use of fertilizers and pesticides is essential to protecting Florida's surface and ground waters. The recently adopted Urban Turf Fertilizer Labeling rule (Chapter 5E-1.003, F.A.C) adopted by FDACS specifies the types of fertilizers that can be sold in Florida for use on urban turf and establishes recommended application rates. The Florida Green Industry BMP Program is an education program developed cooperatively by DEP, the UF-IFAS, and the industry to reduce the impacts of landscape maintenance on our water resources.

### Stormwater Treatment Credit

Developments designed in accordance with the principles of the Florida-friendly landscaping program as set forth below shall receive a three percent (3%) nutrient load reduction credit.

#### Conditions for Credit

A development project shall meet all of the conditions outlined below to qualify for the Florida-friendly landscaping stormwater treatment credit:

- The entire development project shall have all landscaping designed and constructed in accordance with the principles of the Florida Yards and Neighborhoods program.
- The development shall implement and record deed restrictions and other restrictive covenants based on the Model FYN Deed Restrictions and Restrictive Covenants.
- The local government within which the development project is occurring shall have adopted a landscaping land development regulation that incorporates the requirements set forth in the Guidelines for Model Ordinance Language for Protection of Water Quality and Quantity using Florida Friendly Lawns and Landscapes.
- All commercial fertilizer applicators that apply fertilizers within the development shall have been trained in the Florida Green Industry BMP Program as required in Section 403.9338, F.S., and certified pursuant to the requirements in Section 482.1562, F.S.

### **18.5 Rural Subdivisions**

Rural subdivisions offer a lot of opportunity to employ low impact design practices to minimize the stormwater volume and pollutant load generated and to manage the stormwater. Subdivisions with no more than 5% impervious area are considered a rural subdivision provided that:

- (a) No drainage system shall act in a manner that would divert and channelize large areas of overland sheet flow, thereby creating point source discharges that will adversely affect waters or wetlands, or areas beyond the applicant's perpetual control; and
- (b) The applicant's demonstration of compliance with this subsection shall include provision of a typical lot layout showing areas proposed to be cleared of existing vegetation, proposed driveways, buildings, and other impervious areas, and the anticipated percentage of impervious surfaces resulting from projected construction on individual residential lots.

#### **18.5.1 Rural Subdivision Subdivision Requirements**

Rural subdivisions will be presumed to not cause harm to water resources if they provide a stormwater treatment system that:

- (a) It provides the required nutrient load reduction which is determined by the type of water body to which the stormwater system discharges and the associated performance standard as set forth in **Section 3.1** of this Handbook.
- (b) The stormwater treatment system shall consist of roadside swales and vegetated natural buffers.
- (b) Proposed construction shall maintain a minimum 75 foot vegetated buffer, which includes a 25 foot perpetually undisturbed buffer, upland of all wetlands and other surface waters. Only the 25 foot perpetually undisturbed buffer shall be required adjacent to an isolated wetland entirely located within an individual residential lot. An applicant may propose a Vegetated Natural Buffer of less than 75 foot by demonstrating, based on plans, test results,

calculations or other information, that the proposed width is appropriate for the specific site conditions and will provide the required level of nutrient load reduction.

- (d) The project shall maintain a minimum 75 foot buffer adjacent to all project boundaries;
- (e) If it is anticipated that property owners will keep animals, such as horses, cattle, or hogs on their land, then they shall:
  - Not allow the animals into any vegetated natural buffers.
  - Implement appropriate animal management BMPs to minimize the impacts of the animals and their associated wastes on waters or wetlands.
  - These requirements shall be included in any declaration of covenants, conditions, easements and restrictions and shall be identified in all sales contracts by the developer.
- (f) The boundaries of the surface water management system and buffers shall be recorded in plats or easements and included in any declaration of covenants, conditions, easements and restrictions and shall be identified in all sales contracts by the developer. These recorded documents shall be perpetual and applicable to all future sales of property within the development. Language shall also be contained in the recorded documents notifying all individual lot owners that permits are required if any of the following items are proposed:
  1. Alteration to the surface water management system;
  2. Encroachment into the wetlands, wetland buffers, or adjacent off-site property line buffers.

Drainage areas from individual lots in rural subdivision are not required to provide treatment of stormwater provided they are designed, constructed, and maintained in accordance with this section. However, portions of individual lots that drain to a system that serves other activities such as roads, clubhouses, etc., must be included in the treatment calculations for that system

## 19.0 CHEMICAL TREATMENT CRITERIA

### 19.1 Description

Chemical treatment of stormwater runoff is a technology which uses metal salts to rapidly precipitate nutrients, solids, heavy metals, and bacteria from runoff. Virtually all of the existing chemical stormwater treatment systems in the State of Florida use alum for coagulation purposes. A chemical treatment system often has a smaller footprint than a traditional wet or dry pond but requires more frequent maintenance by a trained operator.

### 19.2 Treatment Process Background

Coagulation and clarification of water using metal salts has been practiced since at least Roman times to reduce turbidity and improve the appearance of drinking water and surface water. The predominant chemical agent used in these processes has been aluminum sulfate [Al<sub>2</sub>(SO<sub>4</sub>)<sub>3</sub>], commonly referred to as alum. Lime [Ca(OH)<sub>2</sub>] has also been used, either alone or in combination with alum, as well as iron salts such as ferric sulfate [Fe<sub>2</sub>(SO<sub>4</sub>)<sub>3</sub>] or ferric chloride (FeCl<sub>3</sub>). Since coagulation using lime occurs in the pH range of approximately 10-11, requiring subsequent pH neutralization, and since iron precipitates are unstable under anoxic conditions, alum is commonly the coagulant of choice for treatment of stormwater runoff. Virtually all of the existing chemical stormwater treatment systems in the State of Florida use alum for coagulation purposes.

Chemical coagulation of stormwater originated in 1986 at Lake Ella in Tallahassee, Florida as part of a restoration project to improve water quality in the lake (which is actually a permitted stormwater treatment system). An automatic chemical injection system was constructed to provide treatment of stormwater runoff entering the lake by injecting liquid alum into major storm sewer lines on a flow-weighted basis during rain events. When added to runoff, alum forms non-toxic precipitates which combine with phosphorus, suspended solids, and heavy metals, causing them to be deposited into the sediments of a wet detention pond or in a dedicated settling area, in a stable, inactive state.

The addition of alum to water results in the production of chemical precipitates which remove pollutants by two primary mechanisms. Removal of suspended solids, algae, phosphorus, heavy metals and bacteria occurs primarily by enmeshment and adsorption onto aluminum hydroxide precipitate according to the following net reaction:



Removal of additional dissolved phosphorus occurs as a result of direct formation of AlPO<sub>4</sub> by:

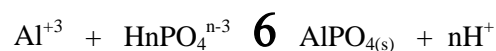

There are numerous advantages associated with the use of alum for coagulation of stormwater runoff. First, alum coagulation provides rapid, highly efficient removal of solids, phosphorus, and bacteria. Liquid alum is relatively inexpensive, resulting in low unit costs per mass of pollutant removed. Unlike iron compounds, alum does not deteriorate under long-term storage. Due to the quality of the raw materials used for manufacture of alum, liquid alum contains substantially less heavy metal contamination than other metal coagulants. Alum floc is chemically inert and is immune to dissolution from normal fluctuations in pH and redox potential in surface waterbodies.

Due to the advantages of using alum for treatment of stormwater runoff compared with other coagulants, this section is intended to address the use of alum. However, this section does not preclude the use of other coagulants provided that the Applicant can provide reasonable assurance through credible research which demonstrates the efficiency and environmental safety of the proposed coagulant.

In a typical alum stormwater treatment system, alum is injected into the stormwater flow on a flow-proportioned basis so that the same dose of alum is added to the stormwater flow regardless of the discharge rate. A variable speed chemical metering pump is typically used as the injection pump. The operation of the chemical injection pump is regulated by a flow meter device attached to the incoming stormwater line to be treated. Mixing of the alum and stormwater occurs as a result of turbulence in the stormsewer line. If sufficient turbulence is not available within the stormsewer line, artificial turbulence can be generated using aeration or physical stormsewer modifications.

Mechanical components for the alum stormwater treatment system, including chemical metering pumps, stormsewer flow meters, electronic controls, and an alum storage tank, are typically housed in a central facility which can be constructed as an above-ground or below-ground structure. Alum feed lines and electrical conduits are run from the central facility to each point of alum addition and flow measurement. Since the capital costs of constructing an alum stormwater treatment system are largely independent of watershed size, alum treatment is popular in large regional retrofit treatment systems.

### **19.3 *Applicability***

Since 1986, alum injection treatment systems have been used for reducing stormwater pollutant loads from lands that were developed before the implementation of Florida's stormwater treatment rules for new stormwater discharges in 1982 (urban stormwater retrofitting). Generally, alum systems have been used in areas where land availability for traditional BMPs was limited by availability or cost. However, with the need to achieve higher levels of nutrient load reduction, alum treatment systems may become more prevalent for treating stormwater from new development or urban redevelopment. Since alum treatment systems are active systems requiring extensive operation and maintenance by a trained operator, these systems will only be permitted if the responsible maintenance entity is a local government, or in some cases, a corporation. Alum stormwater treatment has been shown to provide highly competitive mass removal costs compared with traditional stormwater treatment techniques such as wet detention and wetland treatment. The smaller land area required for alum treatment, combined with high removal efficiencies, results in a lower life-cycle cost per mass of pollutant removed.

### **19.4 *Treatment Efficiency***

Alum treatment systems for new development must meet the minimum level of treatment set forth in the performance standards section of this Handbook. For urban retrofitting systems, the level of treatment shall be maximized as feasible given the site conditions and costs of treatment.

Alum treatment of urban runoff has consistently achieved an 80-95% reduction in total phosphorus, 50-90% reduction in heavy metals, and >99% reduction in fecal coliform. Removal efficiencies typically increase slightly with increasing alum dose. In general, removal patterns and efficiencies for phosphorus species, turbidity, TSS, heavy metals, and coliform bacteria are predictable and consistent for virtually all types of stormwater runoff. In general, the treatment efficiency of an alum system is related to the stormwater characteristics, alum dosage, and the percent of the average annual flow that is treated. However, project-specific removal efficiencies must be provided by each proposed application based on the results of laboratory jar testing.

Typical alum doses required for treatment of urban runoff range from 5-10 mg Al/liter, although concentrations as high as 20 mg Al/l have been used. Pollutant reductions have been observed at alum doses less than 5 mg Al/liter, but floc formation and settling patterns are often too slow to be useful for treatment of urban runoff where floc collection is required.

Alum treatment removal efficiencies for nitrogen can be highly variable. In general, alum treatment has only a minimal effect on concentrations of ammonia and virtually no impact on concentrations of  $\text{NO}_x$  in stormwater runoff. Removal of dissolved organic nitrogen species can also be highly variable, depending upon molecular size and structure of the organic compounds. The only nitrogen species which can be removed predictably is particulate nitrogen. As a result, removal efficiencies for total nitrogen are highly dependent upon the nitrogen species present, with higher removal efficiencies associated with runoff containing large amounts of particulate and organic nitrogen and lower removal efficiencies for runoff flows which contain primarily inorganic nitrogen species. Selection of the "optimum" alum dose often involves an economic evaluation of treatment costs vs. desired removal efficiencies.

### **19.5 Preliminary Design Evaluation to Determine Alum Dosage**

Once alum has been identified as an option for stormwater treatment, laboratory testing must be performed to verify the feasibility of alum treatment and to establish process design parameters. The feasibility of alum treatment for a particular stormwater stream is evaluated in a series of laboratory jar tests conducted on representative runoff samples collected from the project watershed area. This laboratory testing is an essential part of the evaluation process necessary to determine design, maintenance, and operational parameters such as the optimum coagulant dose required to achieve the desired water quality goals, chemical pumping rates and pump sizes, the need for additional chemicals to buffer receiving water pH, post-treatment water quality characteristics, floc formation and settling characteristics, floc accumulation, annual chemical costs and storage requirements, ecological effects, and maintenance procedures. In addition to determining the optimum coagulant dose, jar tests can also be used to evaluate floc strength and stability, required mixing intensity and duration, and to determine design criteria for floc collection systems.

### **19.6 Stormwater Retrofit Systems**

A stormwater retrofit system involves the design of a chemical treatment process for lands that were developed without stormwater treatment. Chemical treatment is popular in retrofit projects for urban areas since alum treatment can provide a high level of treatment in a relatively small footprint.

To determine the alum dosage for retrofit systems, laboratory jar testing must be conducted on a minimum of 3-5 composite stormwater samples collected from the runoff source to be treated. Flow-weighted composite runoff samples will be collected during rain events, with rainfall depths ranging from 0.25-1.50 inches. The composite samples must be collected over the entire

hydrograph for each monitored event. The rainfall depth associated with each monitored event must be recorded.

After the first three runoff samples have been collected and analyzed, the coefficient of variation (C.V.) will be calculated for the measured total phosphorus concentrations in the raw samples. The coefficient of variation is defined as the standard deviation expressed as a percentage of the mean and is calculated according to the following:

$$C.V. = (S.D. / X) \times 100$$

where: C.V. = coefficient of variation  
S.D. = standard deviation  
X = sample mean

If the C.V. for the measured total phosphorus concentrations is less than 50%, indicating a relatively consistent phosphorus concentration, then additional collection of composite runoff samples will not be required. If the C.V. exceeds 100%, then two additional composite samples must be collected, for a total of five composite runoff samples submitted for testing.

In many urban systems, dry weather baseflow can contribute a significant portion of the annual phosphorus loadings. If a significant baseflow is present and is to be treated with the proposed chemical treatment system, then laboratory testing must also be conducted to evaluate the characteristics of the baseflow. A minimum of two composite baseflow samples will be collected and tested in the same manner as the stormwater samples. Baseflow samples will be collected as a 24-hour composite, with sub-samples collected at a minimum of 6-hour intervals.

### **19.7 Alum Treatment for New Development Projects**

When chemical treatment is proposed for new development, the stormwater stream to be treated has not yet been created. For these applications, composite stormwater samples shall be collected from a similar land use category in the general vicinity of the proposed development with a similar degree of impervious surface, land use, traffic loads, and pervious land cover. A minimum of three composite runoff samples will be collected from the similar land use area from rain events in the range of 0.25-1.50 inches and submitted for laboratory testing. This will allow a basic estimate of the anticipated phosphorus concentrations, pH, and alkalinity of the proposed runoff flow. Since this is only an estimate of the anticipated water quality characteristics, the system must be designed with sufficient flexibility to either increase or decrease the applied chemical dose, following construction, to meet the desired level of nutrient load reduction.

### **19.8 Laboratory Jar Testing**

Laboratory jar testing must be conducted on the collected stormwater or baseflow samples to verify the feasibility of the chemical treatment and to establish process design parameters. All laboratory jar tests will be conducted using a minimum sample volume of 1 liter. The laboratory jar testing will be conducted using a standard jar test apparatus with a paddle speed of 60 rpm. The test doses of chemical coagulants will be added to the jar test samples while the sample is stirring. Stirring of the sample will continue for 60 seconds, and the paddles will be removed



from the beaker. The samples will then be allowed to settle under quiescent conditions for a period of 24 hours, and the supernatant will be siphoned off for laboratory analyses.

One of the most significant water quality issues related to coagulant use is the consumption of alkalinity and decrease in pH caused by alum addition. The magnitude of these changes is a function of the characteristics of the raw water. If the water is well buffered, then alum addition may be conducted safely without significant pH concerns. However, if the test water is poorly buffered, then alum addition may cause an undesirable pH reduction. This issue is most appropriately evaluated during the jar testing process. In most cases, the minimum pH of alum treated water occurs approximately 60 seconds following the alum addition. Therefore, an estimate of the immediate pH impacts from the alum addition can be obtained during the lab testing by measuring the pH of the treated water at the completion of the 60-second mixing process. The pH of the alum treated water should also be measured one hour following chemical addition and at 24 hours when the pH of the alum treated water typically reaches equilibrium.

During the coagulation process, the pH of the treated water must not be depressed below a value of 6.0 when discharging to a fresh water receiving water or 6.5 when discharging to a brackish water. If the jar test results indicate that an undesirable pH depression is likely, then a supplemental buffering compound must be used to offset the pH reduction. The proper dosage of the buffering compound is done through jar testing. Common neutralization compounds include sodium hydroxide (NaOH) and sodium aluminate.

The results of the laboratory jar testing will be used to determine the “optimum chemical dose”. The optimum dose is defined as the minimum chemical dose necessary to achieve the desired water quality goals without exceeding the available buffering capacity of the water. This optimum dose will be used to establish the design parameters for the chemical injection system.

Another important aspect of the jar testing procedure is to evaluate the formation and settling characteristics for the generated floc. In general, settling of alum floc generated by treatment of urban runoff is approximately 90% complete in 1-3 hours, with additional settling occurring over a period of 12-24 hours. However, floc settling rates can be highly variable, depending on raw water characteristics. The rate of floc formation and settling characteristics should be monitored during the jar test procedure, including visual observations and time required for complete settling of the generated floc.

### **19.9 Design Criteria**

At a minimum, the design for the chemical treatment system must include the following parameters:

- Range of flow rates to be treated by system
- Recommended optimum coagulant dose
- Chemical pumping rates
- Provisions to ensure adequate turbulence for chemical mixing and a minimum 60 second mixing time
- Sizes and types of chemical metering pumps - must include flow totalizer for alum injected
- Requirements for additional chemicals to buffer for pH neutralization, if any
- Post-treatment water quality characteristics
- Percentage of annual runoff flow treated by chemical system

- Method of flow measurement – must include flow totalizer
- Floc formation and settling characteristics
- Floc accumulation rates
- Recommended design settling time
- Annual chemical costs
- Chemical storage requirements
- Proposed maintenance procedures

#### **19.10 System Safeguards**

If the results of the laboratory jar testing suggest that undesirable reductions in pH are possible, the chemical treatment system must provide continuous monitoring of pH at the discharge from the floc collection or settling area to prevent accidental overdosing by the chemical treatment system. The pH monitoring system must be linked to the chemical injection system to automatically halt chemical injection when the pH of the discharge is not between 6.0 – 7.0 units in fresh receiving waters and is not between 6.5 -7.0 units in brackish receiving waters. Operation of the system can resume when the pH level returns to acceptable levels. Continuous pH monitoring is not required if the Applicant can provide reasonable assurance that the stormwater or receiving water contains sufficient alkalinity that undesirable pH reduction is not a likely concern.

#### **19.11 Floc Collection and Disposal**

In general, capture and collection of the chemical floc must be achieved prior to discharge into Waters of the State. The most common floc collection methods are either a small wet pond or pumping of the floc to a wastewater treatment plant. The settling pond must provide a residence time for the treated runoff based on the minimum time required for floc settling, as determined through the laboratory jar tests conducted at the optimum dose. The floc collection pond must be designed with a safety factor of 1.5 to compensate for additional turbulence within the settling pond compared with the quiescent laboratory jar test conditions. The minimum pond volume is calculated by multiplying the design residence time times the maximum anticipated inflow rate into the pond. An additional dead storage volume must be provided on the bottom of the pond to accommodate floc accumulations over the proposed time interval between floc removal. The pond must be designed such that the incoming stormwater flow does not resuspend the previous floc accumulations.

All chemical treatment systems proposed for new development must provide facilities for floc collection and disposal. However, retrofit projects for existing developments may propose floc discharge and settling directly into the receiving waterbody provided that: (a) the water body is currently eutrophic with a mean average TSI value in excess of 60 over the previous 5 years; (b) a nutrient budget has been conducted for the waterbody which indicates that the sediments are a significant source of phosphorus to the water column; and (c) introduction of the alum floc into the sediments has the potential to reduce internal recycling and further improve water quality. In such cases, the applicant shall conduct and submit a feasibility analysis that provides the information required in this paragraph and which demonstrates there is no feasible alternative for floc collection and disposal. Monitoring requirements, including benthic macroinvertebrate monitoring, will be established by the Agency and included in the permit for such floc collection and disposal systems

The Applicant must clearly outline the proposed method for floc collection and disposal. Common methods for floc disposal include, but are not limited to, discharge into sanitary sewer

systems and land spreading onto drying beds. The floc residual has a number of beneficial uses such as soil amendments to reduce phosphorus release from submerged soils, landfill cover, and phosphorus adsorption media.

#### **19.12 System Discharge**

- (a) Chemical treatment systems that will discharge to wetland or depressional areas rather than directly into the receiving waterbody must evaluate potential water quality changes to the treated stormwater runoff as it discharges through the wetland or depressional area. Since chemical treatment systems are capable of reducing phosphorus concentrations to extremely low values, release of phosphorus from phosphorus-laden soils can reduce the net treatment efficiency of the system and must be addressed in the application.
- (b) Chemical treatment systems that will discharge to the Class G2 ground water through a drainage well or directly into ground water through a sinkhole must meet primary and secondary drinking water standards. Drainage wells must also meet all applicable requirements of the Underground Injection Control regulations.,

#### **19.13 Maintenance Requirements and Entities**

In general, chemical stormwater treatment systems require a higher level of maintenance than is necessary for other stormwater treatment systems. The designer shall provide the owner/operator with an Operator's Manual that specifies the frequency of inspections and the maintenance activities that must be done to assure that the chemical treatment system operates as designed and permitted. A copy of the Operator's Manual shall be provided as part of the ERP application. The owner/operator must provide assurances that a dedicated funding source is available to cover anticipated operator costs, chemical costs and maintenance activities over the life of the system. Only local governments, or, in some cases, corporations will be allowed as the responsible maintenance entity for chemical treatment systems.

#### **19.14 Inspections**

The chemical treatment system shall be inspected annually by a professional engineer registered in the State of Florida with experience in design and operation of chemical treatment systems. The inspection will include the following items:

- Flow monitoring equipment
- Chemical injection system
- Floc collection
- Water quality results

#### **19.15 Monitoring Requirements**

All chemical treatment systems are required to have a minimum level of monitoring to ensure compliance with the permit requirements.

##### **(a) Systems Constructed for New Development**

Chemical treatment systems constructed for new development must obtain the minimum level of treatment as specified in **Section 3.1** of this Handbook. Since chemical treatment systems require

active operation and maintenance to ensure proper operation, the performance of the system must be demonstrated on a periodic basis to ensure that the system continues to meet the required minimum level of treatment. During the first year of operation, monitoring of inflow and outflow for the system will be conducted on a quarterly basis during a storm event with a minimum rainfall depth of 0.25 inches. Inflow monitoring shall be conducted on a flow-weighted basis over the entire hydrograph for the monitored storm event. Outflow monitoring will be conducted as a 24 hour composite sample, beginning from the start of the storm event, with sub-sample collection occurring at least once every 4 hours. The collected samples will be analyzed in a NELAC certified laboratory for the following parameters:

- pH
- Alkalinity
- Total N
- Total P

The results of the monitoring, including characteristics for the monitored storm event, will be submitted to the permitting agency within 90 days of the storm event. If the system is working as permitted, monitoring of two storm events as specified above shall be done on an annual basis during the rainy season.

**(b) Systems Constructed as Retrofit**

Chemical treatment systems constructed as retrofit systems for existing development must ensure that the system continues to meet the required level of treatment as permitted. Monitoring of two storm events as specified above shall be done on an annual basis during the rainy season. Monitoring shall be done as specified in (a) above.

**19.16 Operational Reporting Requirements**

The owner/operator shall maintain records of the following alum injection system operating parameters:

- Flow records showing daily and annual flow
- Alum injection records showing alum injection quantities by storm event
- Amount of alum purchased and used annually
- Inspection logs and required maintenance of repair of all mechanical components
- Flocculant disposal dates and amounts

## **20.0 URBAN STORMWATER RETROFIT PROJECTS**

### **20.1 *Description***

An urban stormwater retrofit is a project that adds treatment to an existing stormwater management system serving existing land uses that results in reduced stormwater pollutant loadings. Retrofit projects do not serve new development or redevelopment. The applicant for a retrofit project must provide reasonable assurance that the retrofit project itself will not result in new adverse water quality and quantity impacts to receiving waters.

If the applicant has conducted, and the Agency has approved, an analysis that provides reasonable assurance that the proposed retrofit will provide the intended pollutant load reduction from the existing system or systems, the retrofit project will not be required to comply with the performance standards set forth in **Section 3.1** of this Handbook.

### **20.2 *Goals and Performance Standards***

Section 62-40.432(2)(c), F.A.C., states that pollutant loading from older stormwater management systems shall be reduced as necessary to restore or maintain the designated uses of waters. The applicant shall conduct a feasibility assessment to determine which BMP(s) and design criteria shall provide the greatest pollutant removal in the most cost-effective manner given the limitations of the project site.

### **20.3 *Design and Selection of Applicable BMPs***

When site conditions allow, stormwater retrofit BMPs shall be designed to the criteria set forth in this handbook. However, in many cases, site constraints commonly encountered in existing, developed areas can limit the type and size of stormwater BMPs used for retrofitting. In addition to the traditional treatment BMPs specified in this handbook, a number of other BMPs may be suitable for retrofitting. However, it is important to assure that the BMPs selected for stormwater retrofitting are effective in removing the pollutants of concern which, in most cases, will be nutrients.

## PART V – METHODOLOGIES AND DESIGN EXAMPLES

The methodologies in this Part V are intended to aid applicants in designing stormwater treatment systems to meet the design and performance criteria in **Parts II, III, and IV** of this Handbook. These methodologies are by no means the only acceptable method for designing stormwater management systems. Applicants proposing to use alternative methodologies are encouraged to consult with Agency staff in a pre-application conference.

### 21.0 METHODOLOGIES, RECOVERY ANALYSIS, AND SOIL TESTING FOR RETENTION SYSTEMS

#### 21.1 *Description*

“Retention systems” are a family of Best Management Practices (BMPs) designed to store a defined quantity of runoff, allowing it to percolate through vegetation and permeable soils into the shallow ground water aquifer, evaporate, or evapotranspire. Stormwater retention works best using a variety of BMPs throughout the project site. Examples of common retention BMPs include (but are not limited to):

- Retention basins which are constructed or natural depressional areas where the basin bottom is graded as flat as possible and turf, seed & mulch (or other equivalent materials) are established to promote infiltration and stabilize the basin slopes. These retention systems are discussed in greater detail in **Section 5** of this *Handbook*.
- Underground Exfiltration Trenches which are discussed in greater detail in **Section 6** of this *Handbook*.
- Underground Retention Systems which are discussed in greater detail in **Section 7** of this *Handbook*.
- Underground vaults/Chambers which are discussed in greater detail in **Section 8** of this *Handbook*.
- Vegetated swales with or without swale blocks which are discussed in greater detail in **Section 9** of this *Handbook*.
- Vegetated Natural Buffers which are discussed in greater detail in **Section 10** of this *Handbook*.
- Pervious pavement with perimeter edge constraints which are discussed in greater detail in **Section 11** of this *Handbook*.

Each of the BMPs listed above have their individual advantages and disadvantages. Cross-sectional diagrams for each of these BMPs are provided in their respective sections of the *Handbook* as noted above. It is not the intent of this section to cover all potential designs. Professional judgment must be used in the design and review of proposed retention BMPs.

The soil’s saturated hydraulic conductivity, depth to the Seasonal High Ground Water Table (SHGWT) and depth to the confining unit (i.e., clay, hardpan, etc.) must be such that the retention system can percolate the Required Treatment Volume (RTV) within a specified time following a storm event. After drawdown has been completed, retention BMPs do not hold any water, thus the

systems are normally “dry.” Unlike detention BMPs, the RTV for retention systems is not discharged to surface waters.

Retention systems provide excellent removal of many stormwater pollutants. Substantial amounts of suspended solids, oxygen demanding materials, heavy metals, bacteria, some varieties of pesticides and nutrients such as phosphorus may be removed as runoff percolates through the soil profile.

Besides pollution control, retention systems can be used to promote the recharge of ground water, to prevent saltwater intrusion in coastal areas and maintain ground water levels in aquifer recharge areas. Retention systems can also be used to help meet the runoff volume criteria for systems that discharge to closed basins or land-locked lakes. However, the use of retention systems are not appropriate if they contribute to a violation of Minimum Flows or Levels in the receiving waters, or if they adversely impact wetlands by hydrologic alteration.

### **21.2 Required Treatment Volume (RTV)**

The RTV necessary to achieve the required treatment efficiency shall be routed to the retention BMP and percolated into the ground. The required level of nutrient removal is specified in **Section 3.1** of this Handbook. The RTV and other design criteria for each type of retention BMP is specified in the section of the Handbook for that particular BMP.

### **21.3 Recovery Time of the RTV**

All retention systems must provide the capacity for the RTV of stormwater to recover to the bottom of the system within 72 hours following a storm event, assuming an average Antecedent Runoff Condition (ARCI). The locations of the RTV (and its corresponding bottom) are shown in the supporting graphic figures of the various BMP Sections noted above. **A safety factor of two (2.0) must be used in the recovery analysis of the RTV.** Two possible ways to apply this safety factor are:

- (a) Reducing the design saturated hydraulic conductivity rates by half; or
- (b) Designing for the required RTV drawdown to occur within half of the required drawdown time.

The safety factor of two (2.0) is based on the high probability of:

- Soil compaction during clearing and grubbing operations,
- Improper construction techniques that result in additional soil compaction under the retention BMP,
- Inadequate long term maintenance of the retention BMP, and
- Geologic variations and uncertainties in obtaining the soil test parameters for the recovery / mounding analysis (noted in subsequent sections below). These variations and uncertainties are especially suspect for larger retention BMPs.

In retention systems, the RTV recovers (is drawn down or dissipated) by natural soil infiltration into the ground water table, evaporation, or evapotranspiration. The opposite is true for underdrain effluent detention systems, which rely on artificial recovery methods such as underground perforated drainage pipes.

Antecedent Runoff Condition (ARC), formally known as Antecedent Moisture Condition (AMC), refers to the amount of moisture and storage in the soil profile prior to a storm event. Antecedent soil moisture is an indicator of wetness and availability of soil to infiltrate water. The ARC can vary from dry to saturated, depending on the amount of rainfall received prior to a given point in time. Therefore, "average ARC" (ARCII) means the soil is neither dry nor saturated, but at an average moisture condition at the beginning of a storm event when calculating recovery time for retention systems.

#### **21.4 Infiltration Processes**

When stormwater runoff enters the retention BMP, standing water begins to infiltrate. This water percolates into the soil in two distinct stages, either vertically (Stage One) through the BMP bottom (unsaturated flow), or horizontally (Stage Two) through the side slopes (saturated flow). One flow direction or the other will predominate depending (primarily) on:

- The depths to the water table and confining unit (i.e., clay or hardpan) below the bottom of the retention BMP, and
- The soil's saturated hydraulic conductivity.

The following paragraph briefly describes the two stages of infiltration, and subsequent subsections present accepted methodologies for calculating infiltration rates and recovery times for unsaturated vertical (Stage One) and saturated horizontal (Stage Two) flow.

Initially, the subsurface conditions are assumed to be:

- The depth to the initial water table below the bottom of the BMP.
- Unsaturated soils above the water table.

When the water begins to infiltrate, it is driven downward as unsaturated flow by the combined forces of gravity and capillary action. Once the unsaturated soil below the BMP becomes saturated (fills the voids in the soil), the water table begins to "mound" (refer to **Figure 21.1**). At this time, saturation below the BMP prevents further vertical movement, and water exiting the BMP begins to flow horizontally. For successful designs of retention BMPs, both the unsaturated and saturated infiltration must be accounted for and incorporated into the analysis.



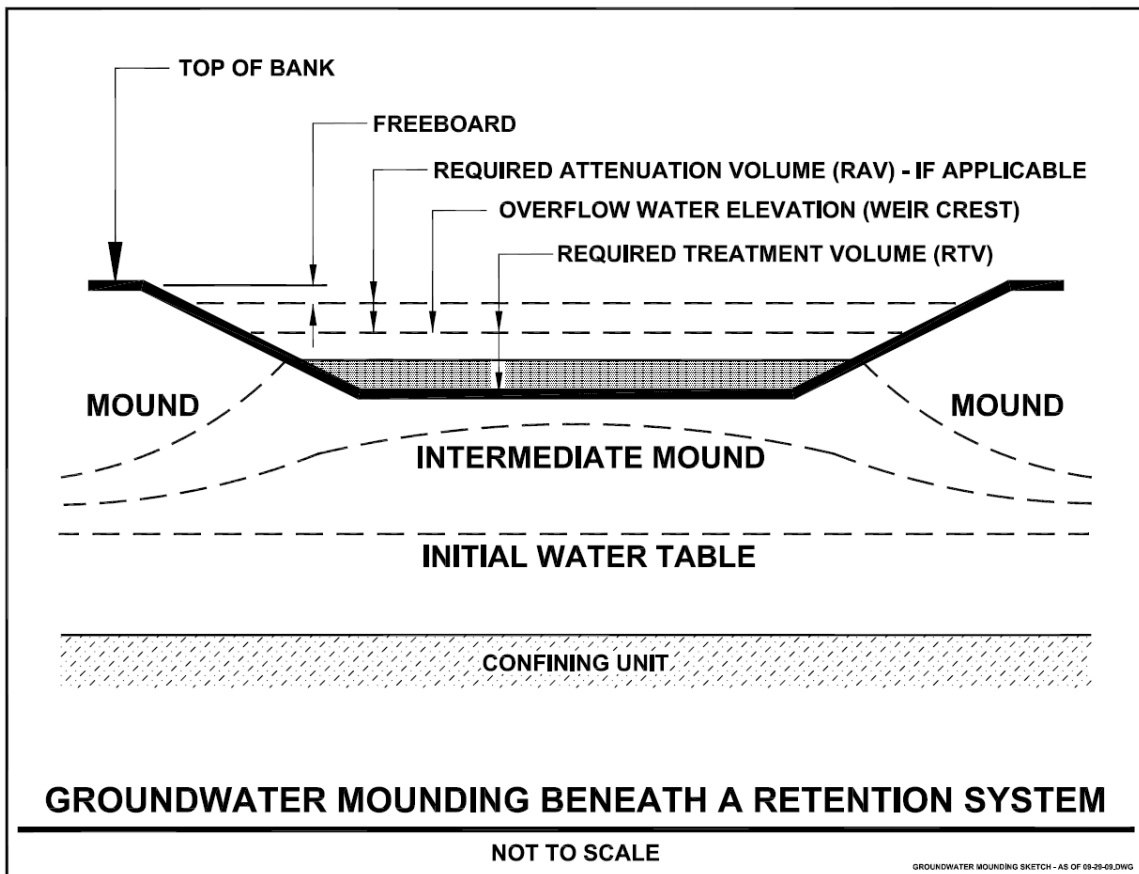

**Figure 21.1 Ground Water Mounding Beneath a Retention System**

**21.5 Accepted Methodologies for Determining Retention BMP Recovery**

- A. Acceptable methodologies for calculating retention BMP recovery are presented below in **Table 21.1**.

**Table 21.1 Accepted Methodologies for Retention BMP Recovery**

Vertical Unsaturated Flow	Horizontal Saturated Flow
Green and Ampt Equation	Simplified Analytical Method
Hantush Equation	PONDFLOW
Horton Equation	Modified MODRET
Darcy Equation	
Holton Equation	

Several of these methodologies are available in commercial software products. The Agencies can neither endorse any software program nor certify software results.

## B. Additional requirements for calculating retention BMP recovery

Unless the normal Seasonal High Ground Water Table (SHGWT) is greater than or equal to 2 feet below the bottom of the BMP system, unsaturated vertical flow prior to saturated horizontal mounding shall be conservatively ignored in the recovery analyses. This is not an unrealistic assumption since the height of the capillary fringe in fine sands is on the order of six (6) inches, and a partially mounded water table condition may be remnant from a previous storm event.

## 21.6 *Requirements, Guidance and Recommendations for Manual Computations or Computer Simulations*

Computer-based ground water flow models are routinely used by practicing engineers and hydrogeologists to predict the time for percolation of the Required Treatment Volume (RTV). The reliability of the output of these models cannot exceed the reliability of the input data. **Input data assessment is probably the most neglected single task in the ground water modeling process.** The accuracy of computer simulations hinges on the quality and completeness of the input data.

The computer models listed in the previous section require input values of the retention BMP dimensions, retained stormwater runoff volume (the RTV) and the following set of aquifer parameters:

- Thickness or elevation of base of mobilized (or effective) aquifer
- Weighted horizontal saturated hydraulic conductivity of mobilized aquifer
- Fillable porosity of mobilized aquifer
- Ambient water table elevation which, for design purposes, is usually the normal Seasonal High Ground Water Table (SHGWT)

Calculated recovery times are most sensitive to the input value for the aquifer's **saturated hydraulic conductivity**.

### A. Determination of Aquifer Thickness

Standard Penetration Test (SPT) borings are recommended for definition of the aquifer thickness, especially where the ground water table is deep. This type of boring provides a continuous measure of the relative density/consistency of the soil (as manifested by the SPT "N" values). A relative density - texture (-200 value) better identifies an aquitard or confining unit.

Manual "bucket" auger borings (when supplemented with classification testing) can also be used to define the thickness of the uppermost aquifer (i.e., the depth to the confining unit), especially for small retention ponds and swales.

#### Definition of SPT "N" Values

The Standard Penetration Test (SPT) consists of driving a split-barrel sampling "spoon" or sampler a distance of 30 cm (12 in) after first "seating" the sampler 15 cm (6 in) by dropping a 63.5 kg (140 lb) hammer from a height of 76 cm (30 in). In field practice, the sampler is driven to a designated depth through a borehole using a long rod, and the hammer strikes the top end of the rod above the ground surface. The operator counts the number of blows that it takes to advance the sampler each of three 15 cm (6 in) increments. When the sampler has penetrated 45 cm (18 in) into the soil at the bottom of the borehole, the operator adds the number of blows for the second and third increments. This

combined number is the result of the SPT and is called the "**blow count**" and is customarily designated as "**N**" or the "**N value**". It directly reflects the penetration resistance of the ground or the soil under investigation.

#### Definition of a Confining Unit

The confining unit is a hydraulically restrictive layer (i.e., a clay layer, hardpan, etc.). For many recovery / mounding simulations, the confining unit can be considered as a restrictive layer that has a saturated hydraulic conductivity an order of magnitude (10 times) less than the soil strata (sands) above. In some cases, the "Physical & Chemical Properties table" [within the older NRCS soil surveys (legacy documents)] identifies these soil strata as having a vertical hydraulic conductivity (permeability by NRCS) of 0.06 to 0.6 inches per hour, with the soil above having a permeability of 0.6 to 6.0 inches per hour.

Another method to supplement the identification of a confining unit is to carefully review the SPT boring logs for increases in the SPT "N" values. SPT "N" values (blow counts) alone should be avoided as the primary method to identify a confining unit.

#### Definition of a Hardpan

A hardpan is a hardened or cemented soil horizon or layer. The soil material is sandy, loamy, or clayey and is cemented by iron oxide, silica, calcium carbonate or other substances.

#### Definition of a Spodic Horizon

Florida's pine Flatwoods areas typically have a spodic horizon into which organic matter has accumulated. In many cases, this spodic horizon is locally called a hardpan. Pine Flatwoods are the most predominant natural landscape in Florida, comprising approximately 8.4 million acres.

### **B. Estimated Normal Seasonal High Ground water Table (SHGWT)**

In estimating the normal SHGWT, the contemporaneous measurements of the water table are adjusted upward or downward taking into consideration numerous factors, including:

- Antecedent rainfall
- Soils on the project site.
- Examination of the soil profile, including redoximorphic features, SPT "N" values, depth to "hardpan" or other impermeable horizons (such as clayey fine sands and clays), etc.
- Consistency of water levels with adjacent surface water bodies and knowledge of typical hydraulic gradients (water table slopes).
- Vegetative indicators
- Effects of existing and future development, including drainage ditches, modification of land cover, subsurface drains, irrigation, septic tank drainfields, etc.

- Hydrogeologic setting, including the potentiometric surface of Floridian aquifer and degree of connection between the water table aquifer and the Floridian aquifer.
- Soil Morphological Features

In general, the measurement of the depth to the ground water table is less accurate in SPT borings when drilling fluids are used to maintain an open borehole. Therefore, when SPT borings are drilled, it may be necessary to drill an auger boring adjacent to the SPT to obtain a more precise stabilized water table reading. In poorly drained soils (HSG “B/D” and “D”), the auger boring should be left open, preferably using Piezometer pipe, long enough (at least 24 hours) for the water table to stabilize in the open hole.

If there is ground water relief within the footprint of the pond, the average ground water contour should be considered representative of the pond.

### C. Estimation of Horizontal Hydraulic Conductivity of Aquifer

The following hydraulic conductivity tests are required for retention BMPs:

- Laboratory hydraulic conductivity test on an undisturbed sample (constant or falling head)
- Uncased or fully screened auger hole
- Cased hole with uncased or screened extension with the base of the extension at least one (1) foot above the confining layer
- Pump test, when accuracy is important and hydrostratigraphy is conducive to such a test method.
- Slug Test(s)

Of the above methods, the most cost-effective is the laboratory hydraulic conductivity test on an undisturbed horizontal sample. However, it becomes difficult and expensive to obtain undisturbed hydraulic conductivity tube samples under the water table or at depths greater than 5 feet below ground surface.

Pump tests are the most expensive of the recommended hydraulic conductivity test methods. Therefore, it is recommended that pump tests be used in cases where the effective aquifer is relatively thick (greater than 10 feet) and where the environmental, performance, or size implications of the system justifies the extra cost of such a test.

When the aquifer is layered, it is possible to combine several layers and consider the resulting medium as homogenous. If the flow through such layers is mainly horizontal, the arithmetic mean of the hydraulic conductivity estimates of the individual layers should be used to obtain the weighted horizontal hydraulic conductivity of the mobilized aquifer as follows:

$$k_h = \frac{k_1 z_1 + k_2 z_2 + \dots + k_n z_n}{Z}$$

where the formation consists of n horizontal isotropic layers of different thickness z, and Z is the combined thickness. Note that these layers are above the restrictive layer of hardpan or clayey material. Since the most permeable layer will control the value of the weighted hydraulic conductivity, it is important that the hydraulic conductivity of this layer be tested.

For design purposes of all retention BMPs, a saturated hydraulic conductivity value over forty (40) feet per day will not be allowed for fine-grained sands, and sixty (60) feet per day for medium-grained sands.

If the mobilized aquifer is thick with substantial saturated and unsaturated zones, it is worthwhile to consider performing a laboratory permeameter test on an undisturbed sample from the upper unsaturated profile and also performing one of the in-situ tests to characterize the saturated portion of the aquifer.

#### **D. Estimation of Fillable Porosity**

In Florida, the receiving aquifer system for retention BMPs predominantly comprises poorly graded (i.e., relatively uniform particle size) fine sands. In these materials, the water content decreases rather abruptly with the distance above the water table and thus has a well-defined capillary fringe.

Unlike the hydraulic conductivity parameter, the fillable porosity of the poorly graded fine sand aquifers in Florida are in a narrow range (20 to 30%), and can be estimated with much more reliability.

For fine sand aquifers, it is therefore recommended that a fillable porosity in the range of 20% to 30% be used in infiltration calculations.

The higher values of fillable porosity will apply to the well- to excessively-drained, hydrologic group "A" fine sands, which are generally deep, contain less than 5% by weight passing the U.S. No. 200 (0.074 mm) sieve, and have a natural moisture content of less than 5%.

No specific field or laboratory testing requirement is recommended, unless there is a reason to obtain a more precise estimate of fillable porosity. In such a case, it is recommended that the following equation be used to compute the fillable porosity:

$$\text{Fillable porosity} = (0.9 N) - (w \gamma_d / \gamma_w)$$

Where N = total porosity  
W = natural moisture content (as a fraction)  
 $\gamma_d$  = dry unit weight of soil  
 $\gamma_w$  = unit weight of water

#### **E. Maximum depth to the SHGWT and confining unit for the required recovery/mounding analysis**

The maximum depths that will be allowed to the SHGWT and the top of the confining unit will be the higher values of:

- The field confirmed SHGWT or confining unit depth(s) from the boring(s) / test pit(s), or

- The termination depth of the field boring / test pit if a SHGWT or confining unit is not encountered.

**F. Requirements and recommendations regarding constructed breaches in the confining unit**

- A detention or retention BMP shall not be excavated to a depth that breaches an aquitard such that it would allow for lesser quality water to pass, either way, between the two systems. In those geographical areas where there is not an aquitard present, the depth of the pond shall not be excavated to within two (2) feet of the underlying limestone which is part of a drinking water aquifer.
- Standard Penetration Test (SPT) borings will be required for any type of deep BMP that has the potential for breaching an aquitard.

**21.7 *Requirements, Guidance and Recommendations for BMP Soil Testing***

One of the most important steps in the evaluation of a stormwater BMPs is determining which test methods and how many tests should be conducted per system. Typically, soil borings and saturated hydraulic conductivity measurements are conducted for each BMP. **Soil testing requirements listed in this Section of the Handbook represent the minimum. It is the responsibility of the registered professional to determine if additional soil borings and hydraulic saturated conductivity tests beyond the minimum are needed due to site conditions. Additional tests shall be required if initial testing results deviate to such an extent that they do not provide reasonable assurance that the site conditions are represented by the data provided.**

Standard Penetration Test (SPT) borings or auger borings are commonly used to determine the subsurface soil and ground water table conditions. Test borings provide a reasonable soil profile and an estimate of the relative density of the soils. However, measurement of the ground water table depth from SPT borings is usually less accurate than from auger borings. Measurement of hydraulic conductivity requires more specialized tests as described in the previous section.

To measure saturated infiltration, several methods are employed in both the laboratory and in the field. Generally, laboratory tests require collection of an “undisturbed” sample of soil, in either the vertical or horizontal condition, often by means of a Shelby tube. Measurements are performed on the sample via a constant head or falling head condition in a laboratory permeameter. Other methods that involve “remolding” of the soil sample are generally not as accurate as the undisturbed sample methodology.

Field methods for measuring saturated hydraulic conductivity include auger hole tests, piezometer tests, and pumping tests. Although these tests can be more time consuming, they test a larger volume of soil and generally provide more representative results.

**A. Restrictions on the use of double ring infiltrometer tests**

The double-ring infiltrometer field test is used for estimating in-situ infiltration rates. If used, these tests must be conducted at the depth of the proposed pond bottom, and shall only be used to obtain the initial “unsaturated” hydraulic conductivity. Once the ground water mound rises to the BMP bottom, the results of a double-ring infiltrometer test are not valid.

**B. Requirements for soil testing**

Information related to soils must include the following:

- Soils test results shall be included as part of a supporting soils/geotechnical report of a project's ERP application. This report must be certified by the appropriate Florida registered professional.
- For all soil borings that are used to estimate the depth to the Seasonal High Ground Water Table (SHGWT), the soil colors shall be denoted by both their English common name and their corresponding Munsell color notation (i.e., light yellowish brown – 10YR 6/4).
- Soil test locations shall be located on the construction drawings, or as an option, the permit review drawings that are submitted as part of the ERP application to the Agency. The horizontal locations of the soil borings/tests shall be placed on the appropriate plan sheet(s), and vertical locations of the soil borings/tests shall be placed on the appropriate retention BMP cross-section(s). The designation number of each test on the plan or cross-section sheets shall correspond to the same test number in the supporting soils/geotechnical report (i.e., SPT #1, Auger boring #2, hydraulic conductivity test #3, etc.).
- The vertical datum of the soil tests results shall be converted to the same datum of the plan sheets and retention BMP cross-sections. For instance, the geo-technical consultant's certified report shows the top of the confining unit in SPT #1 as six (6.0) feet Below Land Surface (BLS). The design consultant of record must then convert this BLS data to the vertical datum of the cross-section sheet for the BMP (NGVD29, NAVD88, or another vertical datum specified by the appropriate regulatory agency).

The location and number of soil borings and saturated hydraulic conductivity tests performed are usually based on the various site characteristics and requires considerable professional judgment and experience in the decision process. **At a minimum, the following number of tests will be required for each proposed BMP unless the specific BMP design criteria do not require soil testing:**

**The minimum number of required Soil Borings** - The greater of the following two criteria:

- One (1) for each BMP, drilled to at least ten (10) feet below the bottom of the proposed BMP system. For instance, if a BMP has a pond bottom 5 feet below existing land surface, the minimum boring depth will be 15 feet below existing land surface.
- **For BMPs larger than 0.25 acre**, retention systems within Sensitive Karst Areas, complex hydrogeology, appreciable topographic relief under the retention BMP, or areas that been filled or otherwise disturbed to change the site's soil characteristics such as in certain urban areas or reclaimed mined lands:

$$B = 1 + \sqrt{2A} + \frac{L}{2\pi W}$$

Where:

**B** = number of required borings under each retention BMP, drilled to at least ten (10) feet below the bottom of the proposed BMP system. For instance, if a retention pond has a pond bottom 5 feet below existing land surface, the minimum boring depth will be 15 feet below existing land surface (rounded up or down to the next whole number).

**A** = average BMP area in acres (measured at the control elevation)  
**L** = length of the BMP in feet (length is the longer of the dimensions)  
**W** = width of the BMP, in feet  
 $\pi$  = PI, approximately 3.14

- For swales, a minimum of one boring shall be taken for each 500 linear feet or for each soil type that the swale will be built on.

For the recovery / mounding analysis, SPT borings should be continuously sampled at least two (2.0) feet into the top of the hydraulically restrictive layer. If a restrictive layer is not encountered, the boring shall be extended to at least ten (10) feet below the bottom of the pond / system. As a minimum, the depth of the exploratory borings should extend to the base elevation of the aquifer assumed in analysis, unless nearby deeper borings or well logs are available.

**Minimum number of required Saturated Hydraulic Conductivity tests** - At a minimum, the following number of tests will be required for each proposed BMP unless the specific BMP design criteria do not require saturated hydraulic conductivity testing. The greater of the following two criteria:

- One (1) for each BMP, taken no shallower than the proposed bottom of the BMP system, or deeper if determined by the design professional to be needed for the particular site conditions. However, if the system will be built on excessively drained soils, the applicant may propose a lesser number of tests based on plans, test results, calculations or other information, that the number of tests is appropriate for the specific site conditions.
- **For BMPs larger than 0.25 acre**, retention systems within Sensitive Karst Areas, complex hydrogeology, appreciable topographic relief under the retention BMP, or urbanized (or reclaimed mining) areas that have undergone previous soil disturbance:

$$P = 1 + (B / 4)$$

Where:

**P** = number of saturated hydraulic conductivity tests for each retention BMP, taken no shallower than the proposed bottom of the retention system, or deeper if determined by the design professional to be needed for the particular site conditions (rounded up or down to the next whole number). However, if the system will be built on excessively drained soils, the applicant may propose a lesser number of tests based on plans, test results, calculations or other information, that the number of tests is appropriate for the specific site conditions.

**B** = number of required borings (from above).

- For wet detention, stormwater harvesting, or underdrain BMPs that have the potential for impacting adjacent wetlands or potable water supply wells, the hydraulic conductivity tests will be required between the location of the BMP and the adjacent wetlands or well.



## 22.0 DESIGN EXAMPLES FOR RETENTION SYSTEMS

**(Note: This chapter will not be adopted as rule. The content is educational and advisory only)**

### 22.1 To Achieve 85% Post-Development Nutrient Load Reduction

#### **Example 1 - Land Uses:**

Predevelopment: 90 acres located on Astatula and Candler soils within Central Florida (Meteorological Zone 2)

Post-development: 90 acres of single-family residential with 25% impervious cover of which 75% is DCIA.

a. **Land Use:** 90 acres of single-family residential

b. **Ground Cover/Soil Types**

A. Residential areas will be covered with lawns in good condition

B. Soil types are HSG A

c. **Impervious/DCIA Areas**

A. Residential areas will be 25% impervious, 75% of which will be DCIA

Impervious Area = 25% of site = 90 ac \* 0.25 = 22.50 acres

DCIA Area = 22.50 acres \* 0.75 = 16.88 acres

DCIA Percentage = (16.88 ac/90.0 ac) \* 100 = 18.76% of developed area

d. **Calculate composite non-DCIA curve number from Table 2-2a of TR-55 (1986):**

Curve number for lawns in good condition in HSG A = 39

Areas of lawns = 90 acres total – 22.50 ac impervious area = 67.50 acres pervious area

Impervious area which is not DCIA = 22.50 ac – 16.88 ac = 5.62 ac

Assume a curve number of 98 for impervious areas

Non-DCIA curve number =

$$\frac{67.50 \text{ ac } (39) + 5.62 \text{ ac } (98)}{67.50 \text{ ac} + 5.62 \text{ ac}} = 43.53 \quad \text{Round to 49}$$

e. **Determine retention volume required for 85% treatment**

From **Appendix D**, using the table for Zone 1, for a DCIA of 40% and a non-DCIA curve number of 49, the retention depth is 1.12 inches of runoff (interpolated result) over the developed area.

The retention volume = 3 ac \* 1.12 in \* 1 ft/12 in = 0.28 ac ft.

**f. Determine retention BMP treatment train**

In meeting the retention volume requirements, there are several options depending on the amount of open space on the site and the location of the SHGWT. If open space is available, retention can be done within recessed landscape and a retention basin. Alternatively, underground retention or exfiltration trenches can be used if the SHGWT is at least two feet below the proposed bottom elevation of these systems. Additionally, the retention requirements can be met by using a greenroof/cistern system for the roof runoff, pervious pavement with recessed landscape islands for the parking area, and a small retention basin for other impervious areas.

**22.2 To Calculate Post-Development Not To Exceed Pre-Development Conditions**

Determine the water quality treatment requirements for a 90-acre proposed single-family residential site. Perform calculations for a project located in Orlando (Meteorological Zone 2). A summary of pre- and post-development conditions is given below.

**I. CALCULATE PRE AND POST DEVELOPMENT LOADINGS**

**Predevelopment Conditions:**

- a. **Land Use:** 90 acres - mixture of pine and oak forest (fair condition)
- b. **Soil Types:** Astatula (50 acres), Candler (40 acres)
- c. **Determine natural vegetative community and TN/TP Groups** (From **Appendix B**)  
Astatula: 20 Acres Sand Pine = Group 1 TN/Group 1 TP; 30 acres Turkey Oak = Group 1 TN/ Group 2 TP  
Candler: 40 acres Turkey Oak = Group 1 TN/Group 2 TP
- d. **Impervious Areas:** 0% impervious, 0% Directly Connected Impervious Area (DCIA)
- e. **Estimation of Undeveloped Loadings:** The total project site covers 90 acres of pine and oak forest. Obtain TN/TP natural areal loadings from **Table 3.2**.

20 Acres Sand Pine, (TN Group 1, TP Group 1): TN = 0.00769 kg/ac-inch/yr

TP = 0.00015 kg/ac-inch/yr

70 acres Turkey Oak (TN Group 1, TP Group 2): TN = 0.00769 kg/ac-inch/yr

TP = 0.00226 kg/ac-inch/yr

Rainfall = 51 inches/yr (**Figure 3.2**)

**Annual TN Load** = 0.00769 kg/ac-inch/yr \* 51 inches/yr \* 90 acres = 35.3 kg

**Annual TP Load** = (0.00015 kg/ac-inch/yr \* 51 inches/yr \* 20 acres) + (0.00226 kg/ac-inch/yr \* 51 inches/yr \* 70 acres) = 0.15 + 8.1 = 8.22 kg

**Post Development Conditions:**

- a. **Land Use:** 90 acres of single-family residential
- b. **Ground Cover/Soil Types**
  - A. Residential areas will be covered with lawns in good condition

B. Soil types will remain Astatula and Candler (HSG A)

**c. Impervious/DCIA Areas**

A. Residential areas will be 25% impervious, 75% of which will be DCIA

Impervious Area = 25% of site = 90 ac \* 0.25 = 22.50 acres

DCIA Area = 22.50 acres \* 0.75 = 16.88 acres

DCIA Percentage = (16.88 ac/90.0 ac) \* 100 = 18.76% of developed area

**d. Calculate composite non-DCIA curve number from Table 2-2a of TR-55 (1986):**

Curve number for lawns in good condition in HSG A = 39

Areas of lawns = 90 acres total – 22.50 ac impervious area = 67.50 acres pervious area

Impervious area which is not DCIA = 22.50 ac – 16.88 ac = 5.62 ac

Assume a curve number of 98 for impervious areas

Non-DCIA curve number =

$$\frac{67.50 \text{ ac } (39) + 5.62 \text{ ac } (98)}{67.50 \text{ ac} + 5.62 \text{ ac}} = 43.5 \quad \text{Round to 44}$$

**e. Calculate annual runoff volume for developed area: The proposed developed area for the project is 90 ac.**

From the tables included in **Appendix E** (Zone 2), the annual runoff coefficient is estimated for a project site with 18.76% DCIA and non-DCIA CN = 44

Annual C value = 0.160

The annual rainfall for the Orlando area = 51.0 inches (**Figure 3.2**)

Annual generated runoff volume = 90 ac \* 51.0 in/yr \* 1 ft/12 in \* 0.160 = 61.20 ac-ft/yr

**f. Calculate post-development loading prior to stormwater treatment: Under post-development conditions, nutrient loadings will be generated from the 90-acre developed single-family area.**

From **Table 3-4**, mean EMC values for total nitrogen and total phosphorus in single-family residential runoff are:

$$\underline{\text{TN} = 1.85 \text{ mg/l}}$$

$$\underline{\text{TP} = 0.31 \text{ mg/l}}$$

(1) **TN load from single-family area**

$$\frac{61.20 \text{ ac} \cdot \text{ft}}{\text{yr}} \times \frac{43,560 \text{ ft}^2}{\text{ac}} \times \frac{7.48 \text{ gal}}{\text{ft}^3} \times \frac{3.785 \text{ liter}}{\text{gal}} \times \frac{1.85 \text{ mg}}{\text{liter}} \times \frac{1 \text{ kg}}{10^6 \text{ mg}} = 139.6 \text{ kg TN/yr}$$

(2) **TP load from single-family area**

$$\frac{61.20 \text{ ac} \cdot \text{ft}}{\text{yr}} \times \frac{43,560 \text{ ft}^2}{\text{ac}} \times \frac{7.48 \text{ gal}}{\text{ft}^3} \times \frac{3.785 \text{ liter}}{\text{gal}} \times \frac{0.31 \text{ mg}}{\text{liter}} \times \frac{1 \text{ kg}}{10^6 \text{ mg}} = 23.4 \text{ kg TP/yr}$$

**g. Calculate required removal efficiencies to achieve post- less than or equal to pre-loadings for TN and TP:** Required treatment efficiencies were calculated using **Equation 3-1**. A summary of pre- and post-loadings and required removal efficiencies is provided below:

**TN:** Pre and post development loadings for TN were calculated to be 35.3 and 139.6 kg/year, respectively, resulting in a required treatment efficiency of 74.7%.

**TP:** Pre and post development loadings for TP were calculated to be 8.2 and 23.4 kg/year, respectively, resulting in a required treatment efficiency of 65.0%.

**II. CALCULATE TREATMENT REQUIREMENTS FOR POST LESS THAN OR EQUAL TO PRE-DEVELOPED NUTRIENT LOADINGS**

**Dry Retention:** For dry retention, the removal efficiencies for TN and TP are identical since the removal efficiency is based on the portion of the annual runoff volume which is infiltrated. The required removal is the larger of the calculated removal efficiencies for TN and TP. For the Orlando area, the annual load reduction is 74.7% for total nitrogen and 65.0% for total phosphorus. Therefore the treatment efficiency is based on the largest required removal which is 74.7%.

Using the tables in **Appendix F** for rainfall zone 2 and multiple interpolations, the retention depth needed to achieve 74.7% nutrient load reduction is 0.26 inches of runoff over the developed area. The retention volume is equal to

$$90 \text{ acres} \times 0.26 \text{ inch} \times 1 \text{ ft}/12 \text{ inch} = 1.95 \text{ acre feet}$$

**22.3 Dry Retention In Series – Calculating Treatment Efficiency Example**

This example allows the comparison of the effectiveness of dry retention basins that are constructed in parallel versus series alignment. It includes a methodology for evaluating the performance efficiency of dry retention basins constructed in series. The latter analysis assumes that each basin runoff loadings from an adjacent watershed area, with the stormwater that does not infiltrate discharging from one basin becoming an input into the next downstream basin. This example includes a total of six retention basins and sub-basin areas. A nodal diagram for the hypothetical development using retention basins in series is given in **Figure 22.3-1**.

**Land Use:** 59 acres will be developed into a single family residential neighborhood in the Orlando area (Rainfall zone 2). The subdivision will have 25% directly connected impervious area and a non-DCIA CN = 75. From **Appendix E**, Rainfall Zone 2, the rainfall coefficient is 0.262. Annual rainfall is 51". The subdivision will consist of different neighborhoods and some

of the stormwater systems will be interconnected as shown in **Figure 22.3-1**. The required level of treatment is post = pre and the higher level of removal effectiveness is 85% for TP.

### Cascading Dry Retention Basin Pond Example

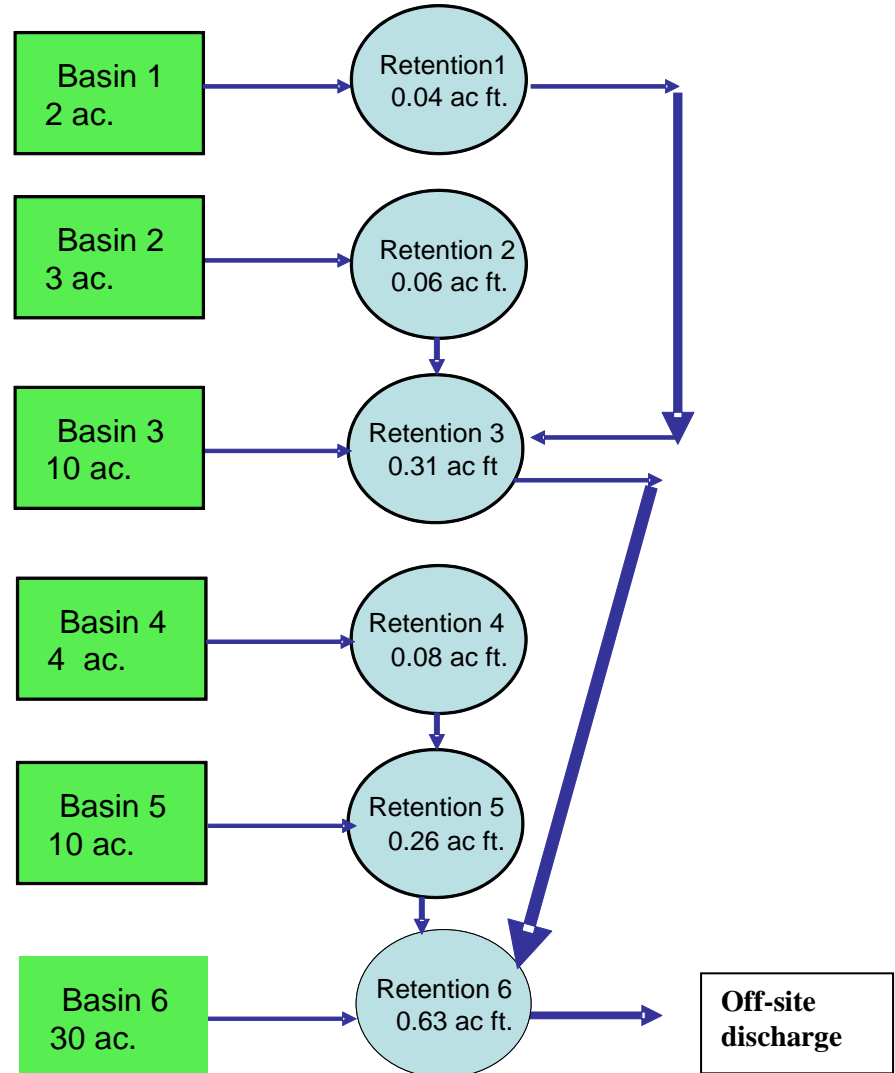

**Figure 22.3-1 Cascading Dry Retention Basin Series Example.**

A summary of generated runoff loadings for the hypothetical community is given in **Table 22.3-1**. Runoff concentrations for total nitrogen and total phosphorus are from **Table 3.4**. The effectiveness of each retention basin is determined by using the Zone 2 charts in **Appendix F**. Results in **Table 22.3-1** are for having all six retention basins functioning as independent BMPs that are in parallel and all discharging off-site after treatment. As can be seen, the nutrient removal effectiveness of each retention basin varies from 85.6% to 91.6% with the overall effectiveness equal to 87.21% nutrient load reduction.

Basin No. and acreage	Retention Basin No.	Annual Runoff Volume (Ac-Ft)	Basin TP Load (pounds)	Retention Basin Volume (inches over DA)	Retention Basin Removal Efficiency	TP Load Discharged (Pounds)	Retention Basin Size (Ac-Ft)
1 – 2 ac	1	2.23	1.88	1.00	85.60%	0.27	0.04
2 – 3 ac	2	3.34	2.82	1.00	85.60%	0.41	0.06
3 – 10 ac	3	11.14	9.38	1.50	91.60%	0.79	0.31
4 – 4 ac	4	4.45	3.75	1.00	85.60%	0.54	0.08
5 – 10 ac	5	11.14	9.38	1.25	89.10%	1.02	0.26
6 – 30 ac	6	33.41	28.15	1.00	85.60%	4.05	0.63
<b>Totals</b>			<b>55.37</b>			<b>7.08=87.21%</b>	<b>1.39</b>

**Table 22.3-1 Dry Retention Treatment Effectiveness for Parallel BMPs**

Notes:

1. Annual runoff volume = basin acres \* annual rainfall \* annual C
2. Basin TP load = annual runoff volume \* 0.31 mg/L (TP EMC from **Table 3.4**)
3. Retention basin removal efficiency from **Appendix F** tables for the specified inches, 25% DCIA, CN=75
4. TP load discharged = basin TP load \* retention basin efficiency

Basin No. and acreage	Retention Basin No.	Total Upstream Acreage	Basin TP Load (pounds)	Retention Basin Volume (inches over DA)	Retention Basin Removal Efficiency	Retention Basin Size (Ac-Ft)
1 – 2 ac	1	2	1.88	1.00	85.60%	0.04
2 – 3 ac	2	3	2.82	1.00	85.60%	0.06
3 – 10 ac	3	15	9.38	1.00	85.60%	0.31
4 – 4 ac	4	4	3.75	1.00	85.60%	0.08
5 – 10 ac	5	14	9.38	0.89	83.60%	0.26
6 – 30 ac	6	59	28.15	0.51	71.50%	0.63
<b>Totals</b>			<b>55.37</b>			<b>1.39</b>

Retention Basin No.	Basin TP Load (pounds)	Pounds Removed In First Retention Basin	Pounds Removed In Retention Basin 3	Pounds Removed In Retention Basin 5	Pounds Removed In Retention Basin 6	TP Load Discharged	
1	1.88	1.61	0.17		0.03	0.00	
2	2.82	2.41	0.26		0.05	0.00	
3	9.38	8.03			0.56	0.79	
4	3.75	3.21		0.32	0.08	0.00	
5	9.38	7.85			0.66	0.88	
6	28.15	20.13				8.02	
<b>Total</b>	<b>55.37</b>					<b>9.69</b>	<b>82.49%</b>

**Table 22.3-2 Dry Retention Treatment Effectiveness for BMPs in Series**

Notes:

1. Pounds removed in first retention basin = basin TP load \* % effectiveness
2. Pounds removed in retention basin 3 = (efficiency of basin 3 [94.7% from **Appendix F** for 2” of retention volume] – efficiency of basin 1) times the basin TP load.
3. Pounds removed in retention basin 5 = (efficiency of basin 5 [94.0% from **Appendix F** for 1.89” of retention volume] – efficiency of basin 4) times the basin TP load.
4. Pounds removed in retention basin 6 = follows the same procedure as used in Notes 2 and 3 except all six basins must be taken into account

Results in **Table 22.3-2** are for the six retention basins functioning in series as shown in **Figure 22.3-1**. As can be seen, the nutrient removal effectiveness of each retention basin individually varies from 71.5% to 85.6% with the overall effectiveness equal to 82.49% nutrient load reduction for all six retention basins in series. This is slightly less than when each retention basin was acting independently in parallel.

## 23.0 METHODOLOGY AND DESIGN EXAMPLE FOR GREENROOF/CISTERN SYSTEMS

(Note: This chapter will not be adopted as rule. The content is educational and advisory only)

### 23.1 To Achieve 85% Post-Development Nutrient Load Reduction

Given: The owner of a building in the Orlando area (Meteorological Zone 2) desires an extensive greenroof system for a 10,000 square foot roof area. An 85% reduction in runoff nutrient load and volume is the target after the greenroof is installed. A cistern must be used because there is no area for other storage on site.

Objective: Determine the necessary cistern volume to accommodate a greenroof system.

#### Design Calculations:

1. Determine the necessary cistern volume to attain the 85% retention efficiency for the system.

**Section 12.9** of this Handbook contains cistern design curves for 18 locations in the State which provide the amount of cistern storage required for a specified annual retention percentage. This is expressed as a fraction of the annual rainfall volume. From the Greenroof Design Curve for the Orlando rainfall station, approximately 4.0 inches of volume over the greenroof area (GR) results in retention of 85% of the annual rainfall. Note for the Orlando area, the percent retention of the greenroof without a cistern is 43%, thus a cistern is needed to achieve 85% removal.

2. Convert the retention in inches to cubic feet and gallons.

Cistern Volume = 4.0 inches/12 inches per foot x 10,000 square feet = 3,330 cubic feet or 25,000 gallons. This can be provided by a number of cisterns located at different sites near the roof drainage, or by one central location.

It should be noted that in some locations, (Niceville as one example), 85% removal cannot be achieved with a greenroof with cistern and thus a treatment train system must be used. For a project located in Lakeland, Florida, the design curve indicates storage of 5 inches (or the maximum depth for any of the design graphs). It is not recommended that a cistern of greater than 5 inches be used because the design curves were not simulated or created for conditions greater than 5 inches of storage.

### 23.2 To Calculate Post-Development Not To Exceed Pre-Development Conditions

Given: The owner of a building in the Orlando area (Meteorological Zone 2) desires an extensive greenroof system for a 10,000 square foot roof area. The targeted load reduction is based on postdevelopment nutrient loads not exceeding predevelopment loads. The pre-condition has a curve number of 82 and there is no impervious area.

Objective: Determine the necessary cistern volume to accommodate a greenroof system and to match post- development nutrient loads not exceeding pre-development conditions.

#### Design Calculations:

1. Calculate the pre- condition annual runoff volume.



From **Appendix E**, a curve number of 82 with no directly connected impervious area results in a mean annual runoff coefficient (C) of 0.13.

2. Calculate the required annual volume retention efficiency.

The retention efficiency necessary to achieve the pre-condition annual runoff volume and nutrient load is expressed in the following equation.

$$\begin{aligned}\text{Efficiency (\%)} &= (1 - \text{Pre-Condition Runoff Volume}) \times 100 \\ \text{Efficiency (\%)} &= (1 - 0.13) \times 100 = 87\%\end{aligned}$$

Therefore, the greenroof and cistern system must retain 87% of the annual rainfall volume.

3. Determine the necessary cistern volume to attain the 87% retention efficiency for the system.

Since the project is located in the Orlando area, we will use the greenroof design curve for Orlando. Thus to achieve 85% removal, approximately 4.6 inches of cistern volume over the greenroof area (GR) must be used.

4. Convert the retention in inches to cubic feet and gallons.

Cistern Volume = 4.6 inches/12 inches per foot x 10,000 square feet = 3,833 cubic feet, or 28,675 gallons is required to accompany the greenroof system. This can be provided by a number of cisterns located at different sites near the roof drainage, or by one central location.

**24.0 METHODOLOGY AND DESIGN EXAMPLE FOR PERVIOUS PAVEMENT**  
(Note: This chapter will not be adopted as rule. The content is educational and advisory only)

**TO BE ADDED IN FUTURE**

**25.0 METHODOLOGY AND DESIGN EXAMPLE FOR WET DETENTION SYSTEMS**  
**(Note: This chapter will not be adopted as rule. The content is educational and advisory only)**

**25.1 BMP Treatment Train To Achieve 85% Post-Development Nutrient Load Reduction**

**Example Land Uses:**

Predevelopment: 90 acres located on Boca soil within Lee County (Rainfall Zone 4)

Post-development: 90 acres of single family residential with 25% impervious cover of which 75% is DCIA.

a. **Land Use:** 90 acres of single-family residential

b. **Ground Cover/Soil Types**

- (1). Residential areas will be covered with lawns in good condition
- (2). Soil types are Boca = HSG D

c. **Impervious/DCIA Areas**

Residential areas will be 25% impervious, 75% of which will be DCIA

Impervious Area = 25% of site = 90 ac \* 0.25 = 22.50 acres

DCIA Area = 22.50 acres \* 0.75 = 16.88 acres

DCIA Percentage = (16.88 ac/90.0 ac) \* 100 = 18.76% of developed area

d. **Calculate composite non-DCIA curve number from Table 2.2a from TR-55 (1986) :**

Curve number for lawns in good condition in HSG D = 80

Areas of lawns = 90 acres total – 22.50 ac impervious area = 67.50 acres pervious area

Impervious area which is not DCIA = 22.50 ac – 16.88 ac = 5.62 ac

Assume a curve number of 98 for impervious areas

Non-DCIA curve number =

$$\frac{67.50 \text{ ac } (80) + 5.62 \text{ ac } (98)}{67.50 \text{ ac} + 5.62 \text{ ac}} = 81.4$$

Round to 81

e. **Calculate annual runoff volume for developed area:**

From the tables included in **Appendix E** (Rainfall Zone 4), the annual runoff coefficient is estimated for a project site with 18.76% DCIA and non-DCIA CN = 81

Annual C value = 0.268 (from interpolation)

The annual rainfall for the Lee County project area = 52.0 inches (**Figure 3.2**)

Annual generated runoff volume = 90 ac \* 52.0 in/yr \* 1 ft/12 in \* 0.268 = 104.5 ac-ft/yr

f. **Calculate post-development loading prior to stormwater treatment:** Under post-development conditions, nutrient loadings will be generated from the 90-acre developed single-family area.

From **Table 3-4**, mean EMC values for total nitrogen and total phosphorus in single-family residential runoff are:

$$\underline{\text{TN} = 1.85 \text{ mg/l}}$$

$$\underline{\text{TP} = 0.31 \text{ mg/l}}$$

**(1) TN load from single-family area**

$$\frac{104.5 \text{ ac} \cdot \text{ft}}{\text{yr}} \times \frac{43,560 \text{ ft}^2}{\text{ac}} \times \frac{7.48 \text{ gal}}{\text{ft}^3} \times \frac{3.785 \text{ liter}}{\text{gal}} \times \frac{1.85 \text{ mg}}{\text{liter}} \times \frac{1 \text{ kg}}{10^6 \text{ mg}} = 238.4 \text{ kg TN/yr}$$

**(2) TP load from single-family area**

$$\frac{104.5 \text{ ac} \cdot \text{ft}}{\text{yr}} \times \frac{43,560 \text{ ft}^2}{\text{ac}} \times \frac{7.48 \text{ gal}}{\text{ft}^3} \times \frac{3.785 \text{ liter}}{\text{gal}} \times \frac{0.31 \text{ mg}}{\text{liter}} \times \frac{1 \text{ kg}}{10^6 \text{ mg}} = 40.0 \text{ kg TP/yr}$$

**g. Calculate required 85% nutrient load reduction**

$$\text{For TN} = 238.4 \text{ kg/yr} \times 0.85 = 202.6 \text{ kg/yr}$$

$$\text{For TP} = 40.0 \text{ kg/yr} \times 0.85 = 34.0 \text{ kg/yr}$$

**h. Determine BMP treatment train to be used to meet required load reduction**

Calculation of the desired design criteria for a wet detention pond is based on determining the residence time required to achieve the desired level of removal efficiencies for TN and TP. Wet detention systems are capable of providing annual mass load reductions for phosphorus in excess of 80% at very long residence times (> 200 days), but the removal efficiency for total nitrogen in wet detention ponds appears to peak at approximately 45%. As a result, wet detention alone is not capable of achieving the required efficiencies of 85% for either TP or TN.

Therefore, if wet detention is desired as a treatment option, some amount of pre-treatment or post-treatment must be provided to enhance the total system performance efficiency to the minimum efficiencies necessary to achieve the required 85% TN and TP load reductions. In some cases, a small amount of dry retention via roadside swales or shallow depressional retention areas may be feasible if soil and ground water conditions allow. In other cases, pervious pavement may be suitable for parking areas such as driveways. Finally, MAPS or stormwater harvesting may be options for increasing the effectiveness of the wet detention system, especially if SHGWT conditions are not suitable for retention pretreatment BMPs.

Assume that the primary component in the treatment train will be a wet detention pond with a residence time of 150 days.

Anticipated TN removal (**Figure 13.3**) =

$$\text{Eff} = \frac{(43.75 \times t_d)}{(4.38 + t_d)} = \frac{43.75 \times 150}{4.38 + 150} = \frac{6562.50}{154.38} = 41.9\%$$

Required TN load reduction of 85% = 202.6 kg/yr

Wet pond TN load reduction = 238.4 \* 0.419 = 99.9 kg/yr, still need 102.7 kg/yr

Anticipated TP removal (**Figure 13-4**) =

$$\begin{aligned} \text{Eff} &= 44.53 + (6.146 * \ln(t_d)) + (0.145 (\ln t_d)^2) = 44.53 + (6.146 \ln(150)) + 0.145 (\ln 150)^2 \\ &= 44.53 + 30.80 + (.0.145 * 25.11) \\ &= 44.53 + 30.80 + 3.64 = 78.97 = 79\% \end{aligned}$$

Required TP load reduction of 85% = 34.0 kg/yr

Wet pond TP load reduction = 40.0 \* 0.79 = 31.6 kg/yr, still need 2.4 kg/yr

Since a wet detention pond by itself cannot meet the required 85% TN and TP removal, the remaining efficiency is achieved using dry retention. The design of the dry retention pond is dictated by the required removal for TN since this is where the largest deficit exists between the required removal and the removal provided by the wet detention pond. The required efficiency for the dry retention is calculated by the equation below:

$$\text{Treatment Train Efficiency} = \text{Eff}_1 + ((1 - \text{Eff}_1) * \text{Eff}_2)$$

where:  $\text{Eff}_1$  = required efficiency of dry retention

$\text{Eff}_2$  = efficiency of wet detention (41.9% for TN)

$$\text{Overall Efficiency} = 0.85 = \text{Eff}_1 + ((1 - \text{Eff}_1) * 0.419)$$

$$0.85 = \text{Eff}_1 + (.419 - .419 \text{Eff}_1)$$

$$0.85 - 0.419 = \text{Eff}_1 - .419 \text{Eff}_1$$

$$0.431 = .581 \text{Eff}_1$$

$$\text{Eff}_1 = 0.742 = 74.2\%$$

The required dry retention depth is estimated from the tables given in **Appendix E** using the development characteristics:

DCIA Percentage = 18.76% of developed area

Non-DCIA CN = 81.

**i. Required Dry Retention Depth**

From **Appendix E** (Zone 4), the required removal efficiency of 74.2% is achieved with a dry retention depth of just less than 0.85 inches over the developed area.

Therefore, the required treatment train will consist of:

- a. 0.85 inch dry retention, followed by
- b. Wet detention pond with a 150-day mean residence time

**j. Wet Detention Pond Characteristics**

The required physical characteristics (volume and allowable depth) of the wet detention pond are determined based on the desired residence time and the impacts of the proposed dry retention pre-treatment.

**(1) Calculate annual runoff inputs to pond**

$$\text{Annual generated runoff volume} = 90 \text{ ac} * 52.0 \text{ in/yr} * 1 \text{ ft/12 in} * 0.268 = 104.5 \text{ ac-ft/yr}$$

The calculated efficiency of 74.2% for the dry retention pre-treatment means that 74.2% of the annual runoff volume will be infiltrated into the ground and will not discharge directly into the wet detention pond. The annual runoff volume which reaches the pond is calculated as:

$$\text{Annual Inputs to Pond} = 104.5 \text{ ac-ft/yr} * (1 - 0.742) = 27.0 \text{ ac-ft/yr}$$

For a 150-day residence time, the pond volume will be:

$$27.0 \text{ ac-ft/yr} * 1 \text{ year/365 days} * 150 \text{ days} = 11.1 \text{ ac-ft}$$

**(2) Estimate maximum allowable pond depth**

The maximum allowable pond depth is directly related to the anticipated algal productivity within the pond. Assuming that wet detention ponds are primarily phosphorus-limited ecosystems, the productivity can be estimated based on the mean TP concentration.

**Estimate runoff characteristics**

For a single-family residential land use, the EMC for TP in runoff can be obtained from **Table 3.4**:

$$\text{TP} = 0.31 \text{ mg/l (single-family residential)}$$

**Calculate TP loading to wet detention pond**

After the dry retention pre-treatment, the annual runoff input to the pond = 27.0 ac-ft/yr

TP load to pond =

$$27.0 \text{ ac-ft/yr} * \frac{43,560 \text{ ft}^2}{\text{ac}} * \frac{7.48 \text{ gal}}{\text{ft}^3} * \frac{3.785 \text{ liter}}{\text{gal}} * \frac{0.31 \text{ mg}}{\text{liter}} * \frac{1 \text{ kg}}{10^6 \text{ mg}} = 10.3 \text{ kg TP/yr}$$

**Calculate TP concentration in pond**

At the proposed 150-day residence time, the TP removal was previously estimated as 79%.

Annual mass of TP remaining in water column =

$$10.3 \text{ kg TP/yr} * (1 - 0.79) = 2.17 \text{ kg TP/yr}$$

This phosphorus mass will be distributed within the pond permanent pool (11.21 ac-ft) and the pond outflow. Assuming that inflow and outflow are approximately equal, the outflow will be 27.0 ac-ft.

Mean pond concentration =

$$\frac{2.17 \text{ kg TP}}{\text{yr}} * \frac{1 \text{ yr}}{11.21 + 27.0 \text{ ac-ft}} * \frac{1 \text{ ac}}{43,560 \text{ ft}^2} * \frac{1 \text{ ft}^3}{7.48 \text{ gal}}$$

$$X \frac{1 \text{ gal}}{3.785 \text{ liter}} \times \frac{10^6 \text{ mg}}{\text{kg}} = 0.046 \text{ mg TP/liter} = 46 \text{ } \mu\text{g TP/liter}$$

### **Calculate mean chlorophyll-a concentration in pond**

The relationship between TP and chlorophyll-a in a Florida waterbody is expressed by the following relationship:

$$\ln(\text{chyl-a}) = 1.058 \ln(\text{TP}) - 0.934$$

where: chyl-a = chlorophyll-a concentration (mg/m<sup>3</sup>)

TP = total P concentration (μg/l)

$$\ln(\text{chyl-a}) = 1.058 \ln(46) - 0.934 = 3.12$$

$$\text{chyl-a} = e^{3.12} = 22.6 \text{ mg/m}^3$$

### **Calculate mean Secchi disk depth**

The relationship between chlorophyll-a and Secchi disk depth in a Florida waterbody is expressed by the following relationship:

$$SD = \frac{24.2386 + [(0.3041)(\text{chyl} - a)]}{(6.0632 + \text{chyl} - a)}$$

where: SD = Secchi disk depth (m)

chyl-a = chlorophyll-a (mg/m<sup>3</sup>)

$$SD = \frac{24.2386 + [(0.3041) (22.6)]}{(6.0632 + 22.6)} = 1.01 \text{ m} = 3.31 \text{ ft}$$

### **Calculate depth of anoxic conditions in pond**

Using the relationship expressed below, the depth of anoxic conditions within the pond can be estimated using the following relationship:

$$\text{Depth of DO} < 1 = 3.035 \times \text{Secchi} + 0.02164 \times (\text{chyl-a}) - 0.004979 \times \text{Total P}$$

where:

Depth of DO < 1 = anoxic depth (m)

Secchi = Secchi disk depth (m)

chyl-a = chlorophyll-a concentration (mg/m<sup>3</sup>)

Total P = total phosphorus concentration ( $\mu\text{g/l}$ )

$$\text{Depth of DO} < 1 = 3.035 (1.01) + 0.02164 (25.7) - 0.004979 (46) = \underline{3.85\text{ m}} = \underline{11.5\text{ ft}}$$

If the proposed pond depth exceeds the estimated photic zone depth of 11.5 ft, aeration or other mixing will be required for areas deeper than 11.5 ft to maintain a well mixed water column. The aeration or mixing must be sufficient to mix the water column to the maximum pond depth. The specific design of the required system should be selected by a qualified aeration specialist.

As an alternative to providing aeration or mixing within the pond, the required permanent pool volume could be considered as only the volume above the anoxic zone and not the entire volume of the pond. Areas below the anoxic depth would be considered as dead storage, although these areas would provide a significant storage volume for collected solids.

If the pond is modified, based on the results of the calculated anoxic zone depth, the calculations would need to be redone to estimate new values for total phosphorus, Secchi disk depth, chlorophyll-a, and depth of anoxia to demonstrate that the new design meets the required permanent pool volume above the zone of anoxia.

**(c) Estimate pond dimensions**

For the estimation of pond dimensions, assume that the mean depth (pond volume/pond area) is  $2/3$  of the maximum depth.

$$\text{Mean pond depth} = 11.5\text{ ft} \times 2/3 = 7.7\text{ ft}$$

$$\text{Pond surface area} = \text{pond volume}/\text{mean depth} = 26.3\text{ ac-ft}/7.7\text{ ft} = 3.42\text{ ac}$$

Therefore, the resultant dry retention and wet detention system required consists of:

Dry Retention: 0.85 Inches of Runoff

Wet Detention: 3.42 Acres of Wet Pond Area with a mean pond depth of 7.7 feet.

**25.2 Wet Detention System Treatment Train to Meet Post=Pre Loading Design Example**

**Example Land Uses:**

Predevelopment: 90 acres located on Hallendale soil within Lee County (Rainfall Zone 4)

Post-development: 90 acres of single family residential with 25% impervious cover of which 75% is DCIA.

**a. Land Use:** 90 acres of single-family residential

**b. Ground Cover/Soil Types**

- (1). Residential areas will be covered with lawns in good condition
- (2). Soil types are Hallendale = HSG C

**c. Impervious/DCIA Areas**

Residential areas will be 25% impervious, 75% of which will be DCIA

$$\text{Impervious Area} = 25\% \text{ of site} = 90\text{ ac} \times 0.25 = 22.50\text{ acres}$$



DCIA Area = 22.50 acres x 0.75 = 16.88 acres  
 DCIA Percentage = (16.88 ac/90.0 ac) x 100 = 18.76% of developed area

**d. Calculate composite non-DCIA curve number from Table 2.2a from TR-55 (1986):**

Curve number for lawns in good condition in HSG C = 74  
 Areas of lawns = 90 acres total – 22.50 ac impervious area = 67.50 acres pervious area  
 Impervious area which is not DCIA = 22.50 ac – 16.88 ac = 5.62 ac  
 Assume a curve number of 98 for impervious areas  
 Non-DCIA curve number =

$$\frac{67.50 \text{ ac } (74) + 5.62 \text{ ac } (98)}{67.50 \text{ ac} + 5.62 \text{ ac}} = 75.85 \text{ round to } 76$$

**e. Calculate annual runoff volume for developed area:**

From the tables included in **Appendix E** (Zone 4), the annual runoff coefficient is estimated for a project site with 18.76% DCIA and non-DCIA CN = 76

Annual C value = 0.238 (from interpolation)

The annual rainfall for the Lee County project area = 52.0 inches (**Figure 3.2**)

Annual generated runoff volume = 90 ac \* 52.0 in/yr \* 1 ft/12 in \* 0.238 = 92.8 ac-ft/yr

**f. Calculate post-development loading prior to stormwater treatment:** Under post-development conditions, nutrient loadings will be generated from the 90-acre developed single-family area.

From **Table 3-4**, mean EMC values for total nitrogen and total phosphorus in single-family residential runoff are:

$$\text{TN} = 1.85 \text{ mg/l} \qquad \text{TP} = 0.31 \text{ mg/l}$$

**(1) TN load from single-family area**

$$\frac{92.8 \text{ ac-ft}}{\text{yr}} \times \frac{43,560 \text{ ft}^2}{\text{ac}} \times \frac{7.48 \text{ gal}}{\text{ft}^3} \times \frac{3.785 \text{ liter}}{\text{gal}} \times \frac{1.85 \text{ mg}}{\text{liter}} \times \frac{1 \text{ kg}}{10^6 \text{ mg}} = 211.70 \text{ kg TN/yr}$$

**(2) TP load from single-family area**

$$\frac{92.8 \text{ ac-ft}}{\text{yr}} \times \frac{43,560 \text{ ft}^2}{\text{ac}} \times \frac{7.48 \text{ gal}}{\text{ft}^3} \times \frac{3.785 \text{ liter}}{\text{gal}} \times \frac{0.31 \text{ mg}}{\text{liter}} \times \frac{1 \text{ kg}}{10^6 \text{ mg}} = 35.48 \text{ kg TP/yr}$$

**g. Calculate required 85% nutrient load reduction**

For TN = 211.7 kg/yr \* 0.85 = 179.90 kg/yr  
 For TP = 35.48 kg/yr \* 0.85 = 30.16 kg/yr

**h. Calculate predevelopment hydrology and loadings**

**Undeveloped Conditions:**

- **Land Use:** 90 acres – forested flatwoods
- **Soil Types:** Hallendale = HSG C soil
- **Determine natural vegetative community and TN/TP Groups (From Appendix B)**  
Hallendale soil = South Florida Flatwoods = TN Group 2, TP Group 1
- **Impervious Areas:** 0% impervious, 0% Directly Connected Impervious Area (DCIA)
- **Estimate Predevelopment Loadings**

The project site covers 90 acres of South Florida flatwoods . Obtain the natural vegetative community areal loadings from **Table 3.2** for rainfall zone 4:

TN = 0.00752 kg/ac-inch-yr, TP = 0.00016 kg/ac-inch-yr,  
Rainfall = 52 inches/yr (**Figure 3.2**)

Annual TN Load = (0.00752 kg/ac-inch-yr) \* 52 inches \* 90 acres = 35.19 kg/yr  
Annual TP Load = (0.00016 kg/ac-inch-yr) \* 52 inches \* 90 acres = 0.75 kg/yr

**i. Calculate required removal efficiencies to achieve post- less than or equal to pre-loadings for TN and TP:** Required treatment efficiencies were calculated using **Equation 3-1**. A summary of pre- and post-loadings and required removal efficiencies is provided below:

**TN:** Pre and post development loadings for TN were calculated to be 35.19 and 211.7 kg/year. Required treatment =  $(1 - 35.19/211.7) * 100 = 83.4\%$ .

**TP:** Pre and post development loadings for TP were calculated to be 0.75 and 35.48 kg/year. Required treatment =  $(1 - 0.75/35.48) * 100 = 97.9\%$ .

Since the required efficiency to achieve post=pre for TP is greater than 85%, the stormwater system normally will be designed to meet the 85% treatment level. However, if the receiving water is an OFW or a verified impaired water, the level of treatment would be post=pre for TP. The rest of this design example will be based on meeting this higher level of treatment.

**j. Determine BMP treatment train to be used to meet required load reduction**

The first step in determining the BMP treatment train is to determine the effectiveness of the wet pond or, in this case, the wet pond plus floating wetland mats. Calculation of the desired design criteria for a wet detention pond is based on determining the residence time required to achieve the desired level of removal efficiencies for TN and TP. Wet detention systems are capable of providing annual mass load reductions for phosphorus in excess of 80% at very long residence times (> 200 days), but the removal efficiency for total nitrogen in wet detention ponds appears to peak at approximately 45%. As a result, wet detention alone is not capable of achieving the required efficiencies of 85% for either TP or TN.

Therefore, if wet detention is desired as a treatment option, some amount of pre-treatment or post-treatment, or both, must be provided to enhance the total system performance efficiency to the minimum efficiencies necessary to achieve the required 97.9% TP load reductions. In some cases, a small amount of dry retention via roadside swales or shallow depressional retention areas may be feasible if soil and ground water conditions allow. In other cases, pervious pavement may be suitable for parking areas such as driveways. Finally, MAPS or

stormwater harvesting may be options for increasing the effectiveness of the wet detention system, especially if SHGWT conditions are not suitable for retention pretreatment BMPs.

Assume that the primary component in the treatment train will be a wet detention pond with a residence time of 200 days.

Anticipated TN removal (**Figure 13.3**) =

$$Eff = \frac{(43.75 \times t_d)}{(4.38 + t_d)} = \frac{43.75 \times 200}{4.38 + 200} = \frac{8750}{204.38} = 42.8\%$$

Required post=pre TN load reduction = 211.7 – 35.2 = 176.5 kg/yr

Wet pond TN load reduction = 211.7 \* 0.428 = 90.6 kg/yr, still need 85.9 kg/yr

Anticipated TP removal (**Figure 13-4**) =

$$Eff = 44.53 + (6.146 * \ln(t_d)) + (0.145 (\ln t_d)^2) = 44.53 + (6.146 \ln(200)) + 0.145 (\ln 200)^2 \\ = 44.53 + 32.56 + (0.145 * 28.07) \\ = 44.53 + 32.56 + 4.07 = 81.16\%$$

Required post=pre TP load reduction = 35.48-0.75 = 34.73 kg/yr

Wet pond TP load reduction = 35.48 \* 0.8116 = 28.8 kg/yr, still need 5.93 kg/yr

If floating wetland mats with an efficiency of 40% nutrient reduction are added to the wet detention system, this results in the following additional load reduction:

TN load remaining = 85.9 kg/yr; TN load reduction = 85.9 \* 0.40 = 34.4 kg/yr which still leaves 51.5 kg/yr TN to remove

TP load remaining = 5.93 kg/yr; TP load reduction = 5.93 \* 0.40 = 2.12 kg/yr which still leaves 3.81 kg/yr TP to remove

The overall efficiency of the wet pond plus the floating wetland mats for TP is equal to:  
28.8 kg/yr + 2.12 kg/yr = 30.92 kg/yr / 34.73 kg/yr = 89.0%

To determine the amount of retention pretreatment that is needed to get the overall 97.9% TP reduction, solve the following equation:

$$Treatment\ Train\ Efficiency = Eff_1 + ((1 - Eff_1) * Eff_2)$$

where: Eff<sub>2</sub> = efficiency of wet detention + floating mats (66.4% for TN)

Eff<sub>1</sub> = required retention efficiency

$$.982 = Eff_1 + ((1 - Eff_1) * .89)$$

$$Eff_1 = .092/.11 = 84.6\%$$

Using the tables in **Appendix F** for a project in rainfall zone 4 with 18.76% DCIA and CN of 81, a retention depth of 1.25' will provide an efficiency of approximately 85%.

### 25.3 Wet Detention In Series – Calculating Treatment Efficiency Example

This example outlines a methodology for evaluating the performance efficiency of wet detention ponds constructed in series. **This methodology is valid for wet detention ponds with annual detention times less than 100 days.** The analysis assumes that each pond receives runoff loadings from an adjacent watershed area, with the discharge from one pond becoming an input

into the next downstream pond. This example includes a total of five ponds and five sub-basin areas. A nodal diagram for the hypothetical development is given in **Figure 25.4-1**. Three separate analyses are provided, one with relatively short pond detention times similar to current designs in the SJRWMD, one with longer pond detention times similar to current designs in SW Florida and in the SFWMD, and one which is modified to achieve an overall annual removal of 85% for total phosphorus.

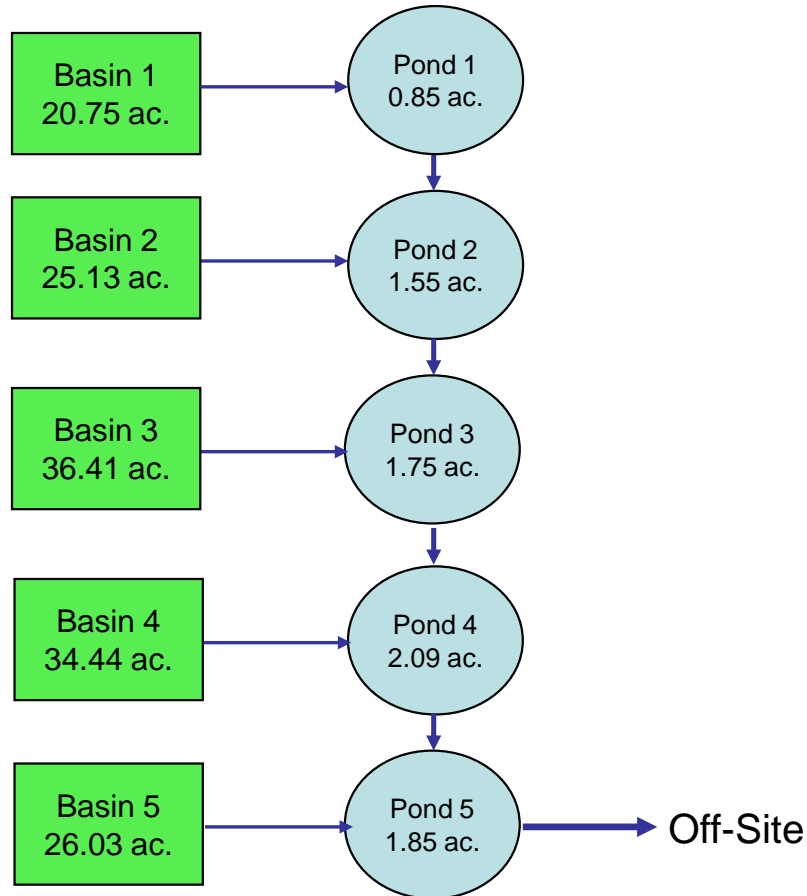

**Figure 25.4 -1 Cascading Wet Detention Pond Example.**  
(NOTE: Pond areas shown are for the short detention time analysis)

A summary of physical and hydrologic characteristics for land use categories in each of the five drainage basin areas is given in **Table 25.4-1**. The hypothetical community consists of a combination of golf course, multi-family residential, low-intensity commercial, entrance roadways, and recreational/open/upland land use categories. The total project area is 142.76 acres, excluding stormwater management systems. The land use categories are divided into five separate basins, each of which discharges into the corresponding wet detention ponds. Information is provided for the area of each land use category, percent DCIA, non-DCIA curve number, annual runoff C value, and the generated annual runoff volume. The listed C values were calculated assuming that the hypothetical community is in meteorological zone 4, with soils in HSG C and D and an assumed annual rainfall of 52 inches/year.

**TABLE 25.4-1 BASIN CHARACTERISTICS FOR EXAMPLE PROBLEM**

Basin No.	Pond No.	Land Use	Area (ac)	Percent DCIA	Non-DCIA CN	C Value	Gen. RO Vol. (ac-ft/yr)
1	1	Golf Course	8.39	0.0	68.3	0.065	2.36
		Multi-Family Residential	12.36	30.0	84.3	0.369	19.76
2	2	Golf Course	6.48	0.0	68.3	0.065	1.83
		Multi-Family Residential	14.91	30.0	84.3	0.369	23.84
		Recreational/Open/Uplands	3.74	0.0	84.0	0.171	2.77
3	3	Low Intensity Commercial	2.11	60.0	93.5	0.646	5.91
		Golf Course	9.25	0.0	68.3	0.065	2.61
		Entrance Roadways	2.47	44.0	90.8	0.526	5.63
		Multi-Family Residential	16.07	30.0	84.3	0.369	25.70
		Recreational/Open/Uplands	6.51	0.0	84.0	0.171	4.82
4	4	Golf Course	6.98	0.0	68.3	0.065	1.97
		Entrance Roadways	2.65	44.0	90.8	0.526	6.04
		Multi-Family Residential	20.66	30.0	84.3	0.369	33.04
		Recreational/Open/Uplands	4.15	0.0	84.0	0.171	3.08
5	5	Golf Course	3.36	0.0	68.3	0.065	0.95
		Entrance Roadways	2.02	44.0	90.8	0.526	4.60
		Multi-Family Residential	16.74	30.0	84.3	0.369	26.77
		Recreational/Open/Uplands	3.91	0.0	84.0	0.171	2.90

A summary of generated runoff loadings for the hypothetical community is given in **Table 25.4-2**. Theoretical runoff concentrations are provided for total nitrogen and total phosphorus based primarily upon the land use characterization data summarized in the Draft Rule. Golf course areas are assumed to have runoff characteristics similar to single-family residential homes. The landscaped entrance roadways are also assumed to have runoff characteristics similar to single-family residential areas. Areas of roadways which are not part of the entrance roadway system are included with each of the identified land use categories. Estimated annual mass loadings of total nitrogen and total phosphorus are calculated for each sub-basin area and each land use category.

**TABLE 25.4-2 GENERATED RUNOFF LOADINGS FOR EXAMPLE PROBLEM**

Basin No.	Pond No.	Land Use	Area (ac)	RO Vol. (ac-ft/yr)	Total N		Total P	
					RO Conc. (mg/l)	Mass Load (kg/yr)	RO Conc. (mg/l)	Mass Load (kg/yr)
1	1	Golf Course	8.39	2.36	2.00	5.83	0.306	0.89
		Multi-Family Residential	12.36	19.76	2.32	56.55	0.520	12.67
		Sub-Total:	20.75	22.13		62.38		13.57
2	2	Golf Course	6.48	1.83	2.00	4.50	0.306	0.69
		Multi-Family Residential	14.91	23.84	2.32	68.21	0.520	15.29
		Recreational/Open/Uplands	3.74	2.77	1.50	5.13	0.055	0.19
		Sub-Total:	25.13	28.44		77.84		16.17
3	3	Low Intensity Commercial	2.11	5.91	1.23	8.96	0.170	1.24
		Golf Course	9.25	2.61	2.00	6.43	0.306	0.98
		Entrance Roadways	2.47	5.63	2.00	13.89	0.306	2.12
		Multi-Family Residential	16.07	25.70	2.32	73.52	0.520	16.48
		Recreational/Open/Uplands	6.51	4.82	1.50	8.92	0.055	0.33
		Sub-Total:	36.41	44.66		111.72		21.15
4	4	Golf Course	6.98	1.97	2.00	4.85	0.306	0.74
		Entrance Roadways	2.65	6.04	2.00	14.90	0.306	2.28
		Multi-Family Residential	20.66	33.04	2.32	94.52	0.520	21.19
		Recreational/Open/Uplands	4.15	3.08	1.50	5.69	0.055	0.21
		Sub-Total:	34.44	44.12		119.96		24.42
5	5	Golf Course	3.36	0.95	2.00	2.33	0.306	0.36
		Entrance Roadways	2.02	4.60	2.00	11.36	0.306	1.74
		Multi-Family Residential	16.74	26.77	2.32	76.59	0.520	17.17
		Recreational/Open/Uplands	3.91	2.90	1.50	5.36	0.055	0.20
		Sub-Total:	26.03	35.22		95.64		19.46
<b>TOTAL:</b>			<b>142.76</b>	<b>174.56</b>		<b>467.53</b>		<b>94.76</b>

**Alternate 1 – Short Pond Detention Times**

A summary of assumed pond characteristics for the short detention time evaluation is given in **Table 25.4-3**. Assumed pond areas range from 0.85-2.09 acres, with mean depths ranging from 5.3-8.7 ft. The pond volumes are intended to provide a mean annual detention time of approximately 30-90 days for each pond, similar to current SJRWMD designs. The total pond area is 8.09 acres which includes only the water surface and is approximately 5.7% of the developed area discharging into the pond. When the side banks and maintenance areas are included, the total project area committed to stormwater management will be approximately 8-10% which is consistent with typical current designs.

**TABLE 25.4-3 POND CHARACTERISTICS – SHORT DETENTION TIMES**

Pond	Area (ac)	Volume (ac-ft)	Mean Depth (ft)
1	0.85	4.5	5.3
2	1.55	12.7	8.2
3	1.75	13.5	7.7
4	2.09	18.1	8.7
5	1.85	14.8	8.0
<b>TOTAL:</b>	<b>8.09</b>	<b>63.6</b>	

A summary of calculations for estimating system removal effectiveness is given in **Table 25.4-4**. In **Table 25.4-4a**, the cumulative pond detention time is calculated for each pond using the following relationship:

$$\text{Detention Time} = \frac{\text{Pond Volume (ac-ft)}}{\text{Volumetric Inputs (ac-ft/yr)}} \times 365 \text{ days/year}$$

Volumetric inputs are assumed to include direct runoff plus cumulative inputs from upstream water bodies. The calculated values in this table represent the cumulative detention time for raw runoff inputs through the cascading pond system.

A summary of calculated phosphorus removal efficiencies for the cascading pond system is given in **Table 25.4-4b**. These removal efficiencies are calculated using the mathematical relationship between detention time and phosphorus removal efficiency in wet detention ponds. The efficiencies are calculated using the cumulative pond detention times summarized in **Table 25.4-4a**, and reflect cumulative phosphorus removal for raw runoff inputs into each pond. This analysis separates the new incoming watershed phosphorus loadings for each pond from the previously treated phosphorus inputs discharging from upstream water bodies. It is assumed that phosphorus inputs into any given pond continue to be removed in downstream ponds as a function of detention time based on the incremental additional detention time provided by the interconnected ponds. Since the majority of the easily removable phosphorus is removed in the initial pond for any given pond sequence, the cumulative phosphorus removals for inputs from upstream ponds decrease rapidly as the overall detention time increases.

For example, phosphorus removal in Pond 1 (**Table 25.4-4a**) is 74% based on a detention time of 74 days. When the remaining mass discharges to the next pond, the additional mass removed is the removal that occurs from days 74-166. In the next pond, the additional removal is the portion that occurs from days 166-218, etc. This process is repeated for each pond.

A summary of incremental percentage phosphorus removal is given in **Table 25.4-4c**. The values summarized in this table simply reflect the differences between the cumulative removal efficiencies for each pond summarized in **Table 25.4-4b**.

A summary of incremental phosphorus mass removal in the cascading pond system is given in **Table 25.4-4d**. The values summarized in this table were obtained by multiplying the input phosphorus loading for each pond times the incremental phosphorus removal percentages

summarized in **Table 25.4-4c**. For example, Pond 1 receives a total phosphorus loading of 13.57 kg/yr. Of this amount, 73.7% (10.0 kg/yr) will be removed in Pond 1 based upon the mean annual detention time of 74 days. When the remaining phosphorus mass discharges from Pond 1 into Pond 2, an additional removal of approximately 6.0% will be achieved during the 92-day detention time in Pond 2. This will result in an additional removal of 1.0 kg of total phosphorus in Pond 2 which originally entered Pond 1. This process is repeated for each of the ponds in a sequential fashion.

A summary of cumulative total phosphorus remaining in each of the five ponds is given in **Table 24.5-4e**. The values listed in the final column of this table can be divided by the cumulative runoff inflow volume in proportion to the lake volume to calculate water column concentrations of total phosphorus, estimation of Secchi disk depth, and anoxic depth for each pond.

The phosphorus removal relationships used in **Table 25.4-4b** are based upon the equation for detention time and phosphorus removal originally presented as **Figure 13-4**. A copy of this figure is provided below (**Figure 25.4-2**).

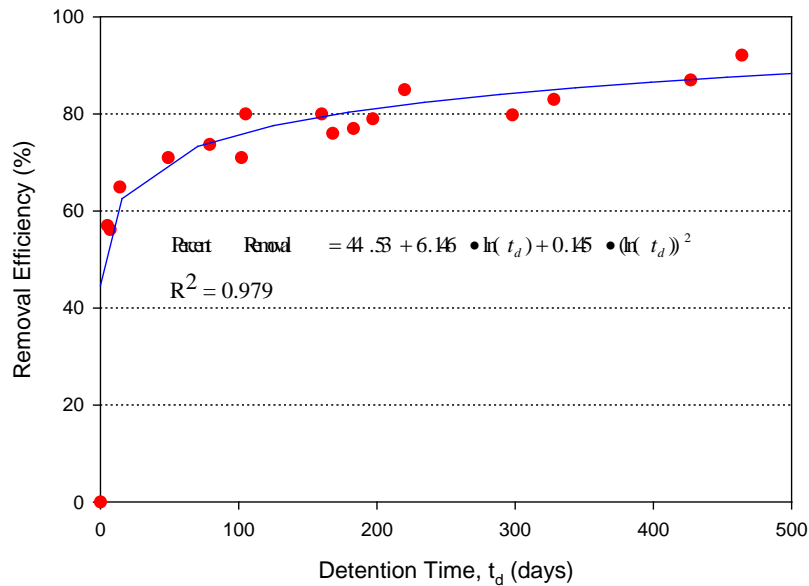

**Figure 25.4-2 Relationship Between Detention Time and Total Phosphorus Removal in Wet Ponds**

The system summarized in the example problem provides an overall removal efficiency of approximately 77.2% for total phosphorus which does not meet the 85% target goal.



**TABLE 25.4-4. POND REMOVAL CALCULATIONS FOR TOTAL P  
(SHORT DETENTION TIMES)**

**a. Detention Time Calculations**

Pond	Det. Time (days)	Cumulative Pond Detention time (days)				
		Pond 1	Pond 2	Pond 3	Pond 4	Pond 5
1	74	74				
2	92	166	92			
3	52	218	143	52		
4	47	265	191	99	47	
5	31	296	222	130	78	31

**b. Calculated Total Phosphorus Removal**

Pond	Det. Time (days)	Cumulative TP Removal (%)				
		Pond 1	Pond 2	Pond 3	Pond 4	Pond 5
1	74	74				
2	92	80	75			
3	52	82	79	71		
4	47	83	81	76	70	
5	31	84	82	78	74	67

**c. Incremental Percent Total Phosphorus Removal**

Pond	Det. Time (days)	Incremental TP Removal (%)				
		Pond 1	Pond 2	Pond 3	Pond 4	Pond 5
1	74	73.7				
2	92	6.0	75.3			
3	52	2.1	3.4	71.0		
4	47	1.5	2.2	4.8	70.4	
5	31	0.9	1.2	2.0	3.7	67.3

**TABLE 25.4-4. POND REMOVAL CALCULATIONS FOR TOTAL P – CONTINUED  
(SHORT DETENTION TIMES) Continued**

**d. Incremental Mass Total Phosphorus Removal**

Pond	TP Load (kg/yr)	Incremental TP Removal (kg/yr)				
		Pond 1	Pond 2	Pond 3	Pond 4	Pond 5
1	13.57	10.0				
2	16.17	1.0	12.2			
3	21.15	0.4	0.7	15.0		
4	24.42	0.4	0.5	1.2	17.2	
5	19.46	0.2	0.2	0.4	0.7	13.1
<b>Total:</b>	<b>94.76</b>					

**e. Cumulative Total Phosphorus Remaining**

Pond	TP Load (kg/yr)	Cumulative TP Remaining (kg/yr)					Pond Load (kg/yr)
		Pond 1	Pond 2	Pond 3	Pond 4	Pond 5	
1	13.57	3.6					3.6
2	16.17	2.6	4.0				6.6
3	21.15	2.2	3.3	6.1			11.6
4	24.42	1.8	2.8	5.0	7.2		16.7
5	19.46	1.6	2.5	4.6	6.5	6.4	21.6

Overall System Removal =

$$\frac{\text{Input Mass} - \text{Discharge Mass}}{\text{Input Mass}} = \frac{94.76 \text{ kg/yr} - 21.6 \text{ kg/yr}}{94.76 \text{ kg/yr}} \times 100 = \underline{77\%}$$

**Alternate 2 – Long Pond Detention Times – To be added**

## 26.0 METHODOLOGY AND DESIGN EXAMPLE FOR STORMWATER HARVESTING SYSTEMS

(Note: This chapter will not be adopted as rule. The content is educational and advisory only)

### 26.1 Design Examples for Stormwater Harvesting Systems

#### A. Example Problem #1 (Determine E; Given R and V)

Given: 10 acre watershed in meteorological zone 4 that is 70% impervious  
Runoff coefficient for the pervious area at a rainfall of 4 inches is = 0.2  
Maximum runoff storage volume available in a pond = 109,000 ft<sup>3</sup>  
Area available for irrigation = 9.5 acres (an adjacent plot of land under same ownership)  
An irrigation demand model specifies a 0.74 inch/week average rate of irrigation.

Objective: What is the efficiency (E) or the percent of runoff not discharged for the use rate and runoff storage pond size available? And what is the % average annual nitrogen mass removed if the pond nitrogen removal effectiveness is 50%?

#### Design Calculations

Step 1. Determine the *EIA*. From **Equation 15-1**, the runoff coefficient (*C*) is:

$$C = \frac{7 \text{ ac } (1.0) + 3 \text{ ac } (0.2)}{10 \text{ ac}} = 0.76$$

The effective impervious area (*EIA*) is found from Equation 15-2:

$$EIA = 0.76 (10 \text{ ac}) = 7.6 \text{ ac}$$

Step 2. Convert the available runoff volume (*V*) units to inches over the *EIA*.

$$V = 109,000 \text{ ft}^3 \times \frac{1}{7.6 \text{ ac}} \times \frac{1 \text{ ac}}{43560 \text{ ft}^2} \times \frac{12 \text{ inches}}{1 \text{ ft}} = 3.95 \text{ inches}$$

Note: the rainfall volume at which the pervious runoff is determined is 4 inches.

Step 3. Find the use rate (*R*) in units consistent with Meteorological Zone 4 REV chart (**Figure 15-7**)

$$R = (0.74 * 9.5) / 7.6 = 0.93 \text{ in/week over the EIA or } 0.13 \text{ in/day over the EIA}$$

Step 4. What is the effectiveness or the percent of the runoff that is reused?

Using **Figure 15-7**, two of the variables are known, *R* and *V* with an irrigation rate of 0.93 in/week (0.13 in/day) over the *EIA* and an available runoff storage volume of 3.95 inches over the *EIA*. This results in a harvesting efficiency of 70%.

Step 5. Determine the percent nutrient mass removed from direct discharge with harvesting.

$$\begin{aligned} \text{Average Annual Nutrient Mass Removal} &= \text{weighted harvesting efficiency} + \text{pond efficiency} \\ &= (.70)(1.00) + (.30)(.50) = 0.85 \text{ or } 85\% \end{aligned}$$

## **B. Example Problem #2 (Determine $V$ ; given $E$ and $R$ ) and supplemental water demand.**

### **Part 1:**

Given: 20 acre watershed in meteorological zone 2 that is 50% impervious with an annual rain of 50". The discharge from the pervious area is about 30% based on a rain depth of 1 inch. 9 acres are available for irrigation at an average rate of 0.8 inch per week. Required treatment efficiency or percent of water not discharged is 50.

### **Determine the runoff storage volume ( $V$ )**

#### Design Calculations

Step 1. Determine the  $EIA$ . From **Equation 15-1**, the runoff coefficient ( $C$ ) is:

$$C = [10ac (1.0) + 10 ac (0.3)]/20 = 0.65$$

The effective impervious area ( $EIA$ ) is found from **Equation 15-2**:

$$EIA = 0.65 (20 ac) = 13 ac$$

Step 2. Convert the use rate units to inches per day over the  $EIA$ .

$$R = \frac{9 ac \times 0.8 inch/week}{13 ac \times 7 days/week} = 0.08 inch/day \text{ on the } EIA$$

Step 3. Find the reuse volume ( $V$ ). From the meteorological zone 2 REV chart (**Figure 15-5**),

$$V = f (50\%; 0.08 \text{ inches/day over the } EIA) = 1.0 \text{ inches over the } EIA$$

Step 4. Convert the runoff storage volume ( $V$ ) units to  $ft^3$

$$V = 1.0 \text{ inch} \times 13 ac \times 1 ft/12inch \times 43,560 ft^2/ac = 47,190 \text{ cubic feet}$$

Thus a runoff storage volume of 47,190 cubic feet is needed at a rate of use equal to 0.8 inch per week over 9 acres to achieve an effectiveness of 50%.

### **How much supplemental water is needed in meteorological zone 2?**

The runoff water harvested is 50% of 50 inches per year and from 13 acres is equal to 325 Ac-in. The harvest pond water used for irrigation is on average 0.8 in/week over 9 acres and is equal to 374 Ac-in. Thus the supplemental volume of water needed is 49 ac-in (primarily for use in the dry months). The actual amount will depend on the actual ET, timing of rainfall and volumes during the year.

### **Part 2: What is the annual runoff harvesting effectiveness if the stormwater harvesting pond were in meteorological zone 1 with the same watershed conditions?**

Using the REV curve for meteorological zone 1 with a use rate of 0.08 inches/day and a pond volume of 1.0 inches over the  $EIA$ , effectiveness is estimated from the REV Chart (**Figure 15.4**) as 40%.

### **Part 3: What is the phosphorus reduction if the harvesting pond is designed for the watershed conditions of Part 1 and the phosphorus pond concentration can be reduced by 70%?**

The average annual phosphorus mass removal effectiveness is  $100[1-(1-.50)(1-.70)] = 85\%$

### **C. Example Problem #3 (Determine E; Given R and V)**

**Given:** A multi-story 3.5 acre hotel complex (watershed) in meteorological zone 4 is 100% impervious. However there is a runoff storage volume (*V*) available in the pond which is equal to 0.875 ac-ft. 136,300 gallons of water per week are used in the cooling tower of the building complex as well as for washing of commercial vehicles.

**Objective:** Determine the reuse efficiency, or equivalent treatment efficiency (*E*); and if the detention pond removed 60% of the total phosphorus, determine the total mass of runoff phosphorus removed from the discharge.

#### **Design Calculations**

**Step 1.** Determine the *EIA*. Since the site is 100% impervious, the *EIA* = 3.5 acres

**Step 2.** Convert the use volume (*V*) units to inches over the *EIA*.

Converting runoff storage volume to gallons or .875 ac-ft = 285,100 gallons

$$V = 285,100 \text{ gallons} \times 1/7.48 \text{ gal/ft}^3 \times 1/3.5 \text{ acres} \times 1/43,560 \text{ ft}^2/\text{ac} \times 12 \text{ in/ft} = 3.00 \text{ inches or}$$

$$V = 0.875 \text{ ac} - \text{ft} \times \frac{1}{3.5 \text{ ac}} \times \frac{12 \text{ inches}}{1 \text{ ft}} = 3 \text{ inches on the EIA}$$

**Step 3.** Convert the use rate units to inches per day over the *EIA*.

$$R = 136,300 \text{ gal/day} \times 1/7.48 \text{ gal/ft}^3 \times 1/3.5 \text{ ac} \times 1/43,560 \text{ ft}^2/\text{ac} \times 12 \text{ in/ft} \times 1/7 \text{ d/wk} = 0.205 \text{ in/day}$$

**Step 4.** Determine the harvesting efficiency from the meteorological zone 4 REV chart (**Figure 15.7**).

$$E = f(0.205 \text{ inches/day}; 3.0 \text{ inches}) = \text{about } 83\%$$

**Step 5.** Determine the total phosphorus % removed from direct discharge.

$$\begin{aligned} \text{Percent Removal} &= \text{weighted harvesting efficiency} + \text{pond efficiency} \\ &= (.83)(1.00) + (.17)(.60) = 0.93 \text{ or } 93\% \end{aligned}$$

## **27.0 METHODOLOGY AND DESIGN EXAMPLE FOR SWALES**

**(NOTE: This chapter will not be adopted as rule. The content is educational and advisory only)**

**TO BE ADDED IN FUTURE**

**28.0 METHODOLOGY AND DESIGN EXAMPLE FOR VEGETATED NATURAL BUFFER SYSTEMS**

**(Note: This chapter will not be adopted as rule. The content is educational and advisory only)**

**TO BE ADDED IN FUTURE**

## **29.0 METHODOLOGY AND DESIGN EXAMPLE FOR UNDERDRAIN FILTRATION SYSTEMS**

**(Note: This chapter will not be adopted as rule. The content is educational and advisory only)**

**TO BE ADDED IN FUTURE**



## **30.0 SPECIAL BASIN CRITERIA: SENSITIVE KARST AREAS**

Many areas of the State contain geology that is known broadly as karst. For the purposes of this Handbook, Sensitive Karst Areas (SKAs) are identified by the applicable Water Management District as shown in the maps and legal descriptions in **Appendix G**. In addition to the stormwater treatment system design criteria established earlier in this Handbook, projects located within the SKAs also must meet the additional design criteria of **Sections 30.3** of this Handbook.

### **30.1 Background of the Sensitive Karst Area Design Criteria**

The Floridan Aquifer System is the drinking water source for most of the population in the State of Florida. In many parts of the State, limestone (or dolostone) that makes up or comprise this aquifer system occurs at or near the land surface. Sediments overlying the limestone can be highly permeable. The limestone, due to its chemical composition, is susceptible to dissolution when it interacts with slightly acidic water. “Karst” is a geologic term used to describe areas where landscapes have been affected by the dissolution of limestone or dolostone, including areas where the formation of sinkholes is relatively common. SKAs reflect areas with hydrogeologic and geologic characteristics relatively more conducive to potential contamination of the Floridan Aquifer System from surface pollutant sources. The formation of karst-related features such as sinkholes is also more likely to occur in SKAs.

### **30.2 Hydrogeology of the Sensitive Karst Areas**

The highly porous limestone that comprises the Floridan Aquifer System is generally overlain by tens to hundreds of feet of sands, clays, and other material. Where present, this material may act to protect, to varying degrees, the Floridan Aquifer System from surface pollutants. Surface water seeps through this material slowly, which allows for some degree of filtration, adsorption, and biological transformation or degradation of contaminants.

In SKAs, however, the limestone that comprises the Floridan Aquifer System may occur at or near the land surface (**Figure 30.1**), and sand overburden, confining clays, or other confining cover material is absent or discontinuous. As a result, there can be rapid movement of surface water and possibly entrained contaminants into the aquifer. The SKAs are areas of relatively high recharge to the Floridan Aquifer System. Floridan Aquifer System ground water levels vary from land surface to approximately 290 feet below land surface in the SKAs.

One factor that makes the SKAs particularly prone to stormwater contamination is the formation of solution pipe sinkholes within retention basins. Solution pipe sinkholes are common in these areas and form due to the collapse of surficial material into vertical cavities that have been dissolved in the upper part of the limestone (**Figure 30.1**). They are also formed by the movement of surface material into the underlying porous limestone. In most cases, the solution pipes are capped by a natural plug of sands and clays (**Figures 30.1** and **30.2**). If the cap is washed out (as may happen if a large volume of water is stored over the solution pipes), the resulting solution pipe sinkhole (**Figure 30.3**) can act as a direct pathway for the movement of surface water into the Floridan Aquifer System.

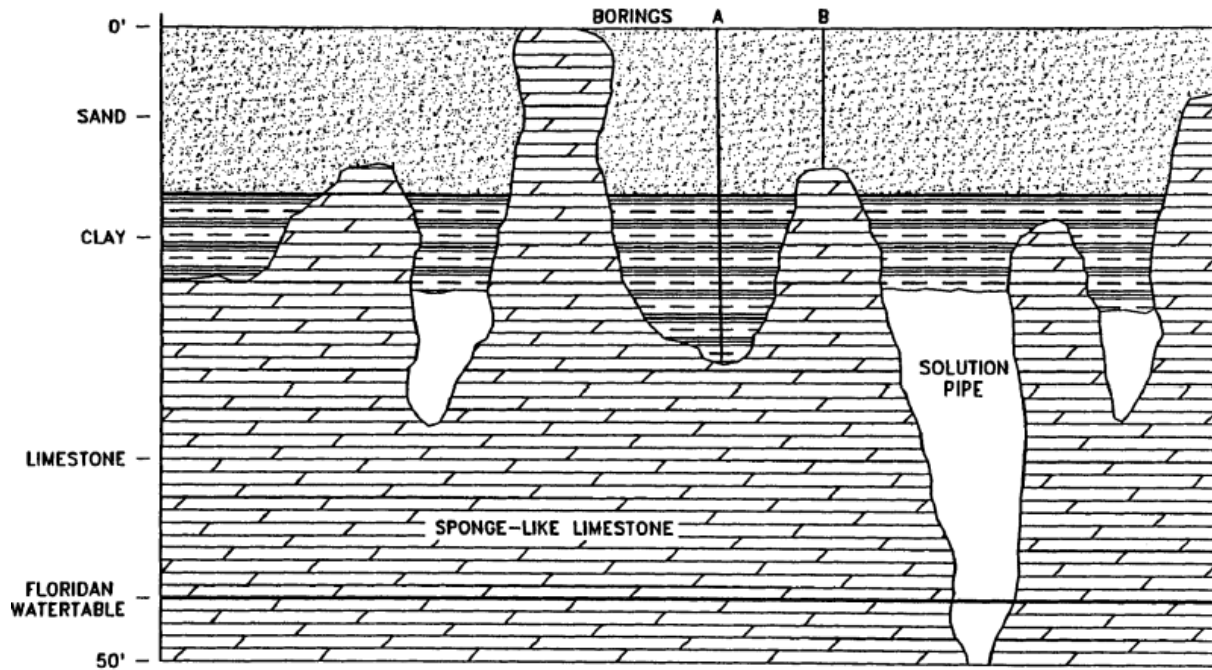

Figure 30.1. Generalized Geologic Section in Sensitive Karst Area with Limestone at and near Land Surface

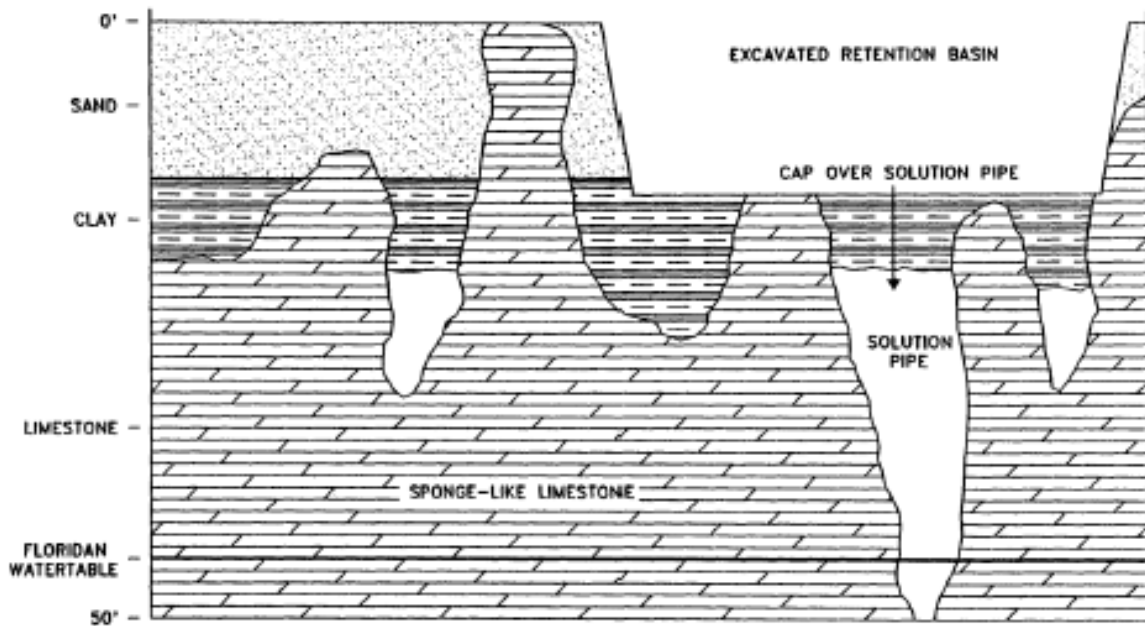
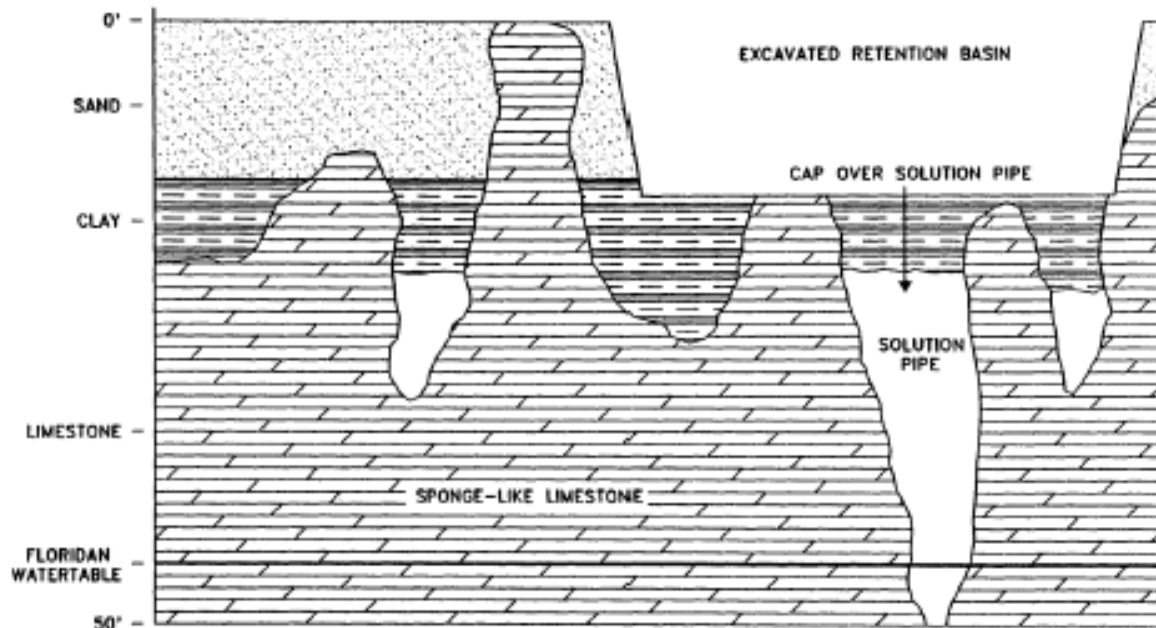

Figure 30.2. Retention Basin Added to Figure 30.1



**Figure 30.3. Potential Sinkhole Resulting from Change in Physical Conditions Due to Constructed Retention Basin Depicted in Figure 30.2**

Solution pipe sinkholes and other types of sinkholes may open in the bottom of stormwater retention basins. The capping plug or sediment fill may be reduced by excavation of the basin. Stormwater in the basin may increase the hydraulic head on the remaining material in the pipe throat. Both of these factors can wash material down the solution pipe. Solution pipes act as natural drainage wells and can drain stormwater basins.

The irregular weathering of the limestone surface in the SKAs contributes to uncertainty and errors in predicting the depth from land surface to limestone. For example, in **Figure 30.1**, boring A would show limestone much deeper than it would actually be encountered during excavation, shown at boring B. This potential for error must be considered for site investigations when evaluating site borings, and load-specific geological analyses must be included to base site designs.

### 30.3 Additional Design Criteria for Sensitive Karst Areas

**30.3.1** Stormwater treatment systems shall be designed and constructed to prevent direct discharge of untreated stormwater into the Floridan Aquifer System. They also shall be designed and constructed in a manner that avoids breaching an aquitard and such that construction excavation will not allow direct mixing of untreated water between surface waters and the Floridan Aquifer System. The system shall also be designed to prevent the formation of solution pipes or other types of karst features in the SKAs. Test borings located within the footprint of a proposed stormwater treatment system must be plugged in a manner to prevent mixing of surface and ground waters.

Stormwater treatment systems constructed within Sensitive Karst Areas shall meet the design criteria set forth earlier in this Handbook and also be designed to meet the following requirements:

- (a) A minimum of three feet of unconsolidated soil material between the surface of the limestone bedrock and the complete extent of the bottom and sides of the stormwater basin. Excavation and backfill of unconsolidated soil material shall be conducted, if necessary to meet these criteria. As an alternative, an impermeable, permanent and suitably protective liner (e.g., clay, geotextile membrane, or other proven method) can be used to ensure that stormwater is isolated from communication with ground water (e.g., for wet detention). This provision is presumed to provide reasonable assurance of adequate treatment of stormwater before it enters the Floridan Aquifer System.
- (b) To reduce the potential for solution pipe sinkhole formation caused by a large hydraulic head, stormwater storage areas and basin depths shall not exceed 10 feet (shallower depths are encouraged) and shall have a horizontal bottom (no deep spots);
- (c) Fully vegetated basin side slopes and bottom (if not a wet pond) planted with turf grass or other appropriate vegetation suitable for growing in the conditions in which it is planted.
- (d) The above requirements represent the minimum requirements for stormwater treatment system design in SKAs. However, depending on the potential for contamination to the Floridan Aquifer (i.e., structural failure, artesian conditions, industrial/commercial land uses, excessively rapid infiltration rates), more stringent requirements may apply, including but not limited to:
  - More than three feet of material between the limestone bedrock surface and the bottom and sides of the retention basin;
  - Basin liners (clay or geotextile) or soil amendments;
  - Sediment sumps at stormwater inlets;
  - Offline treatment;
  - Ground water monitoring;
  - Oil/water separators; and
  - Expanded geotechnical analysis of existing soil, geologic, and lithologic data of the project area that demonstrates reasonable assurance that the proposed stormwater treatment system complies with all permitting conditions for issuance.

**30.3.2** Applicants who believe that their proposed system is not within the influence of a karst feature, notwithstanding that it is within the SKAs designated by the Water Management District, and therefore wish to design their system other than as provided in **Section 30.3.1** of this Handbook, shall furnish the Agency with alternative reasonable assurances that the proposed system complies with **Section 30.3.1** of this Handbook. Such reasonable assurance shall consist of:

- (a) A geotechnical analysis consisting of existing soil, geologic, and lithologic data of the project area that demonstrates the presence of an aquitard consisting of at least 20 feet of unconsolidated low permeability material [clay (particle size less than 0.002mm) content >10%] below the pond bottom that will not be breached by the proposed design and construction; or
- (b) The presence of a minimum of 100 ft. of unconsolidated material from the bottom of the pond and the top of the limestone as demonstrated by core borings within the proposed pond area; or

- (c) A geotechnical study, analysis and system design that demonstrates that the existing soil, geologic, and lithologic data of the project area are suitable for stormwater treatment system not designed to the special requirements for Sensitive Karst Areas.

A registered professional shall be required to certify that the submitted information, the site characteristics, and the project design provide reasonable assurance of compliance with **Section 30.3.1** of this Handbook.

**30.3.3** In addition to sites identified by the Water Management District as karst sensitive, the Agency shall require compliance with the criteria in **Section 30.3.2** of this Handbook when available data and information indicate that a substantial likelihood exists that a proposed stormwater management system on a site has the potential to be located within the influence of a karst feature based on methodologies generally accepted by registered professionals, and has the potential to adversely affect the Floridan Aquifer System.

**30.3.4** The applicant shall provide a map showing the location of existing public and private potable water supply wells within 200 feet of the proposed stormwater treatment system.

**30.3.5** When during construction or operation of the stormwater management system, a structural failure (bottom drop-out) is observed corrective actions designed or approved by a registered professional shall be taken as soon as practical to correct the failure. The failure will be reported to the Agency within 48 hours of discovery. A sinkhole evaluation and repair plan that provides reasonable assurance that the breach will be permanently corrected prepared by a registered professional must be provided as soon as practical, but no later than 30 days after sinkhole discovery, to the Agency for review and approval.

### **30.3.6 Special Conditions for Permit Issuance in SKAs**

All permits issued for projects subject to the requirements in **Section 30** of the Handbook shall include the following special conditions:

- (a) If limestone bedrock is encountered during construction of the stormwater treatment system, the Agency shall be notified within 48 hours and all construction in the affected area shall cease.
- (b) The Permittee shall notify the Agency of any sinkhole development within the stormwater treatment system within 48 hours of discovery and must submit a sinkhole evaluation and repair plan that provides reasonable assurance that the breach will be permanently corrected, prepared by a registered professional, as soon as practical, but no later than 30 days after sinkhole discovery, to the Agency for review and approval.
- (c) The stormwater treatment system will be inspected monthly by the Permittee to determine if any sinkholes have opened in the stormwater system. An annual inspection and certification from the appropriate registered professional stating that the stormwater treatment system is functioning consistent with all permit conditions shall be submitted to the Agency. If the system is not operating as permitted, the registered professional shall submit a restoration plan for approval by the Agency.

## **PART VI – INSPECTION, OPERATION, MAINTENANCE OF STORMWATER TREATMENT SYSTEMS**

(NOTE: This chapter will not be adopted as rule. The content is educational and advisory only)

The following two Sections of the Handbook set forth the requirements to assure that all permitted stormwater treatment systems are constructed, operated, and maintained in accordance with permit and rule requirements. **Section 31** of this Handbook sets forth general requirements for inspections and maintenance, as well as, requirements for specific BMPs. Section 31 of this Handbook sets forth specific requirements for inspections, maintenance, and recertification of stormwater treatment systems.

### **31.0 INSPECTION, OPERATION, AND MAINTENANCE OF STORMWATER TREATMENT SYSTEMS**

#### **31.1 Inspection Requirements**

Successful operation of a stormwater treatment system depends on each step of the process – design, permitting, construction, final inspection and certification, operation, OM inspections, and maintenance practices - being correctly executed. Once construction is satisfactorily completed, the long term assurance of stormwater system performance and compliance with permit requirements begins. Stormwater treatment systems are expected to perform their functions for as long as the land use they serve exists. Routine inspections are needed during construction, upon completion of construction at which time record drawings must be submitted, and after.

##### **31.1.1 Inspection during Construction**

During construction the inspector or registered professional shall assure that the stormwater treatment system components (BMPs) are built in compliance with the permitted plans and specifications. Items of particular focus include the following.

- Verifying the location and dimensions of all permitted BMPs onsite prior to construction and excavation of any stormwater system component's. Design requirements such as distances to building foundations, potable wells, septic tanks, etc. need to be verified.
- Observations during initial excavation of the soil to verify that soil, water table, and geologic conditions are consistent with the information in the permit application and permitted design specifications. Significant deviations from the permitted specifications should be noted and the permitting agency notified if the deviations will adversely affect the stormwater treatment system performance.
- Observations of the design and construction elevations of each of the components of the stormwater treatment system to assure that the stormwater will flow and be treated as designed and permitted.
- Assuring that the effects of soil compaction after final grade establishment have been evaluated and mitigated as needed to assure proper system operation, especially for retention BMPs.

##### **31.1.2 Final Construction Inspection**

After the stormwater treatment system construction and stabilization is complete, a final inspection is needed to verify that all of the system's components have been constructed in accordance with the permitted design and specifications. Required record drawings and certifications from the appropriate design professionals shall be based on this final inspection.

### 31.1.3 Inspections after Construction is Complete

Periodic inspections and recertifications by the appropriate registered professional are required to assure that the stormwater treatment system continues to function in accordance with the permitted design and specifications. In addition to the required inspection and recertification, inspections are needed at regular intervals to assure that all design features and specifications continue to function properly. The stormwater system's Operation and Maintenance Plan, prepared by the system's design professional, will include specific recommendations for the frequency of inspection and for specific maintenance activities that must be done to assure long term performance.

### 31.2.1 Stormwater Treatment System Maintenance

Stormwater treatment systems incorporate a wide variety of processes and components to achieve their desired objectives. It is important for permittees (facility owners) to recognize that *each type of system has its own unique maintenance demands and priorities*. For example, while both infiltration and wet detention systems will capture and retain sediment and debris, the wet pond's permanent pool will normally make it more difficult, time-consuming, and expensive to remove sediments than from the normally dry bottom in the infiltration basin. However, the removal of sediments from a properly constructed wet detention pond typically is only needed once every 10 to 15 years, while an infiltration facility often requires annual removal.

Different types of stormwater treatment systems also many have different types of components (Table 31-1), all of which *will also impose different maintenance demands*. For example, trash racks, low flow channels, and adjacent areas of the bottom will collect more sediment and debris than emergency spillways, side slopes, dams, and other components and will, therefore, require more frequent and thorough cleaning. Conversely, the structural integrity of dams, embankments, emergency spillways, and outlet structures are, relatively speaking, more vital to the safety of the facility and downstream areas and, therefore, will warrant more thorough inspection and more immediate repair than low flow channels, perimeters, or bottoms.

### 31.2.2 Aesthetic and Functional Maintenance

All stormwater BMPs require regular maintenance to assure that they continue to operate in accordance with permitted designs, specifications, and other requirements. Maintenance requirements shall be specified by the registered professional in the facility's operation and maintenance plan.

Maintenance can be broken into two primary categories – aesthetic/nuisance maintenance and functional maintenance. Aesthetic maintenance primarily enhances the visual appeal and appearance of the stormwater treatment system. It is obviously more important for systems that are highly visible. Functional maintenance is necessary to keep the retention basin operating in accordance with permit requirements and has two components: Preventive maintenance and corrective maintenance.

**Table 31-2. Major Components of Stormwater Management Systems**

<b>COMPONENT</b>	<b>DESCRIPTION</b>
PRINCIPAL OUTLET	Hydraulic structure that controls and conveys the facility's outflow to the downstream conveyance or receiving water.
EMERGENCY OUTLET	Hydraulic structure or spillway that safely conveys emergency overflows from the facility. Includes approach and exit channels.
DAM/EMBANKMENT	Wall or structural fill that impounds runoff in the facility above the adjacent ground surface.
BOTTOM	The lowest or deepest surface within the facility.
SIDE SLOPES	Slopes at dams, embankments, spillways, and facility perimeters constructed through excavation or filling.
TRASH RACK	Device placed upstream of the principal outlet or drain to intercept trash and debris that would otherwise block it.
LOW FLOW SYSTEM	Surface and/or subsurface measures that convey low and dry weather inflows to the principal outlet without storage.
INLETS	Upstream surface and/or subsurface conveyance measures that discharge runoff into the facility.
OUTFLOW SYSTEMS	Downstream surface and/or subsurface conveyances or water bodies which receive facility outflows from the principal outlet.
PERIMETER	Area immediately adjacent to the facility.
ACCESS SYSTEMS	Measures and devices that provide maintenance personnel and equipment access to various facility components.
VEGETATIVE COVER	Vegetation planted on various facility components to stabilize their surfaces and/or provide stormwater treatment.
BYPASS SYSTEM	A system which allows a facility owner to temporarily bypass the stormwater facility to allow a maintenance activity to occur in the "dry".

**(a) Preventive maintenance**

Preventive maintenance is the maintenance which is done on a regular basis to prevent problems from occurring that could prevent the facility from operating in compliance with permit requirements. Typical preventive maintenance tasks include upkeep of any mechanical components, maintenance of vegetative cover, sediment removal, trash and debris removal, and elimination of mosquito breeding habitats. Specific examples of preventive maintenance include:

- Conducting maintenance in accordance with manufacturers' recommendations of valves, skimmers, grates, pumps, or any other mechanical components.
- Maintenance of vegetative cover to prevent erosion of system bottom, side slopes or around inflow and outflow structures. Grass needs to be mowed and grass clippings removed from the basin to reduce internal nutrient loadings.
- Removal of accumulated sediments as needed to prevent reduction of the storage volume of the facility.
- Removal of debris and trash to prevent outlet structures, trash racks, and other facility components from becoming clogged and inoperable during storms.



- Elimination of mosquito breeding habitats such as areas where stormwater does not properly infiltrate or where cattails or other invasive vegetation becomes established.

**(b) Corrective Maintenance**

Corrective maintenance is required on an emergency or non-routine basis to correct problems and restore permitted operational capabilities of the facility. Corrective maintenance is not done on a scheduled basis but on an as needed basis. Failure to promptly address a corrective maintenance problem may jeopardize the performance and integrity of the facility. It may also present a potential safety problem to those living adjacent to or downstream of the facility. Corrective maintenance activities include:

- Removal of debris, trash, or sediment that threaten the system’s ability to store or convey stormwater, such as a blocked inlet or outlet
- Repairs to any structural components of the system, especially at inlets or discharge structures.
- Repairs to dams, embankments, or slopes which may be necessitated by settlement, scouring, cracking, sloughing, seepage or rutting. Dewatering of the system may be needed for such repairs.
- Removal of trees, woody vegetation, or animal burrows on dams, embankments, or slopes.
- Repair of fences to limit public access where needed to protect public safety.

**31.2.3 Stormwater Treatment System Operation and Maintenance Plan**

Since each stormwater treatment system is somewhat unique, an operation and maintenance plan specific for the permitted system is needed to assure that the owner/permittee knows what needs to be done to assure long term performance. This is important to help the permittee more easily

- (1) understand and appreciate the overall inspection and maintenance requirements, including permitting requirements;
- (2) establish a coordinated and effective implementation plans;
- (3) establish performance goals that are understood by key people, including the owner and the designated responsible individual;
- (4) plan for future expenditures needed to assure that the stormwater system continues to function as designed and permitted.

The written OM plan should include:

- The name of the permittee/owner – operator and current contact information.
- The name of the person responsible for assuring OM is done (the responsible person).
- The names and/or positions of the various maintenance staff members and, if helpful, an organization chart.
- A list and map of all stormwater system components along with their location, type, and other pertinent details.
- A list and description of each of the identified maintenance and inspection tasks for each of the system’s components and for the overall system.
- Lists of all required and available equipment and material.
- All regular inspection and maintenance schedules.
- Inspection checklists.
- Copies of the pertinent sections of all regulations, permits, approvals, and agreements.
- Copies of maintenance and inspection logs.
- Specifying record keeping procedures – a record of past maintenance efforts and the results of previous inspections will greatly assist the continued effectiveness and cost-

- effectiveness of the maintenance program.
- An "as built" plan of the system.

The written plan will also include or reference other pertinent facility information such as design computations, construction and as-built plans, emergency action plans (where required or developed). A list of off-hour telephone or pager numbers of key maintenance personnel should also be included in case of emergencies.

There shall be at least two identical copies of the maintenance plan. The owner of the facility must have one of the plans while the permitting agency should have the other. If a third entity assumes maintenance responsibility on behalf of the owner, that entity must also have a copy.

The maintenance plans should be located where they can be referred to as the need arises. The permitting agency should have a permanent file system where all maintenance plans reside and are available for public review. The owner's plan should be placed with other important property information, and reviewed at least on an annual basis to ensure that the plan is in good condition and accurately reflects ongoing efforts.

### **31.3 Inspection Checklists**

Checklists are an important and easy tool to ensure that all system components are functioning as originally permitted and constructed. Checklists provide for consistency of site inspection. They help to assure that all relevant facility components are inspected and they provide a historical record of facility inspections. They also can form the basis for reinspection following maintenance to assure that all needed maintenance activities were satisfactorily completed.

**Appendix G** includes Inspection Checklists that can be used by registered professionals or they can serve as models for custom designed inspection checklists.

### **31.4 Maintenance of Infiltration Practices**

There are several different types of infiltration practices – basins, trenches, swales, buffers, pervious pavements, greenroof/cisterns. These BMPs must go dry between storm events to provide their permitted stormwater treatment requirements. Maintenance issues associated with retention BMPs are related to clogging of the porous soils which prevents infiltration slowing recovery of the stormwater treatment volume, often resulting in standing water. Clogging can result from sedimentation and resulting sealing of the soil or rock in the infiltration system. It can also occur from excessive loading of oils and greases (such as from a gas station), excessive algal or microorganism growth. Standing water can also result from an elevated high water table or from ground water mounding, both of which can present long term operational issues that may require redesign of the system.

To determine if an infiltration system is properly functioning or whether it needs maintenance requires that an inspection be done during and soon after a storm. The inspection should determine if the infiltration BMP is recovering its storage volume within its permitted time frames, generally 24 to 72 hours after a storm. If this is not occurring resulting in standing water, then the cause of must be determined and appropriate actions undertaken beginning with those specified in the system's Operation and Maintenance Plan.

Specific examples of preventive maintenance include:

(a) **RETENTION BASINS**

- Monitor facility for sediment accumulation in the bottom and storage volume recovery (i.e., drawdown capacity). Inspections shall be done within 24 to 72 hours after a storm. Failure to percolate stored runoff to the design treatment volume level within 72 hours indicates reduction of the infiltration rate and a need to restore system permeability
- Removal of accumulated sediments – this should be done when the system is dry and when the sediments are “cracking”.
- Maintenance of vegetative cover to prevent erosion in the basin bottom, side slopes or around inflow and outflow structures. Vegetation roots also help to maintain soil permeability and the vegetation promotes evapotranspiration. Grass needs to be mowed and grass clippings removed from the basin to reduce internal nutrient loadings.
- Removal of debris and trash to prevent outlet structures, trash racks, and other facility components from becoming clogged and inoperable during storms.
- Elimination of mosquito breeding habitats such as areas where stormwater does not properly infiltrate or where cattails or other invasive vegetation becomes established.
- Assuring that the contributing drainage area is stabilized and not a source of sediments.

(b) **EXFILTRATION TRENCHES (FRENCH DRAINS)**

1. Routine Maintenance Monitor facility for sediment accumulation in the pipe (when used) and storage volume recovery (i.e., drawdown capacity). Observation wells and inspection ports should be checked following 3 days minimum dry weather. Failure to percolate stored runoff to the design treatment volume level within 72 hours indicates binding of soil in the trench walls and/or clogging of geotextile wrap with fine solids. Reductions in storage volume due to sediment in the distribution pipe, also reduces efficiency. Minor maintenance measures can restore infiltration rates to acceptable levels short term. Major maintenance (total rehabilitation) is required to remove accumulated sediment in most cases or to restore recovery rate when minor measures are no longer effective or cannot be performed due to design configuration.
  - Inspect appurtenances such as sedimentation and oil and grit separation traps or catch basins as well as diversion devices and overflow weirs when used. Diversion facilities and overflow weirs should be free of debris and ready for service. Sedimentation and oil/grit separators should be scheduled for cleaning when sediment depth approaches cleanout level. Cleanout levels should be established not less than 1 foot below control elevation of the chamber.
  - Remove sediment from sediment or oil/grease traps, catch basin inlets, manholes, and other appurtenant structures and dispose of properly.
  - Remove debris from the outfall or “Smart Box” (diversion device in the case of off-line facilities).
  - Removal of sediment and cleaning of trench system. This process normally involves facilities with large pipes. Cleanout may be performed by suction hose and tank truck and/or by high-pressure jet washing.
  - Assuring that the contributing drainage area is stabilized and not a source of sediments

2. Corrective or Rehabilitative Maintenance:

- Total rehabilitation of trench. Excavate and remove perforated or slotted pipe, surrounding coarse aggregate envelope (bedding) and geotextile fabric (wrap). In

most cases renovation will require replacement with new material of equivalent grade and quality. Trench walls should be excavated to expose clean soil. Sediment, contaminated soil, coarse aggregate, and filter cloth shall be disposed of properly.

(c) **Underground Vault/Chamber Systems**

1. General

Regular, routine inspection and maintenance is an important component of this type of underground system to ensure that it functions in a satisfactory manner. The maintenance intervals for an underground vault / chamber are typically more frequent than standard “dry” retention ponds. The performance of the underground system will be related to the effectiveness of the up-gradient sediment / trash removal devices and the frequency of inspections and maintenance activities for all of the vault / chamber system components.

2. Inspection Frequency

- **After a large storm event [typically greater than one (1) inch of rainfall]:** To ensure the (continued) free flow of stormwater, inspect the system and remove accumulated trash and debris from the up-gradient sediment / trash removal devices, and the inflow and outflow points of the down-gradient underground vault / chamber system.
- **Every 6 months:** Perform a comprehensive inspection of the underground system for accumulated trash, debris and organic matter, and remove / dispose of these contaminants to ensure unimpeded stormwater flow. As appropriate, clean the surface of the sub-grade sands by raking, and check for accumulations in the various underground areas. If the sediment / contaminate accumulation is greater than two (2) inches, a vacuum truck and / or similar equipment may be necessary for removal operations. Removed contaminants shall be taken to an approved offsite landfill.
- **Annually, during September:** Monitoring of the drawdown time for the stormwater through the sub-grade sands shall be done to ensure recovery within 72 hours after the last rainfall event. Monitoring and observation of the drawdown times can be done visually through the inspection ports after a storm event. The drawdown of the water quality treatment volume (RTV) must recover within 72 hours after the storm event. If appropriate, post-construction hydraulic conductivity testing of the non-compacted soil floor [and their subsequent (certified) reports] shall be performed by the appropriate Florida licensed professional. Any post-construction soil testing reports shall be submitted to the permitting Agency upon request.

3. Specific Maintenance Activities and Requirements

The guidelines outlined below are intended to provide a comprehensive schedule that gives reasonable assurance that regulatory agency requirements and recommendations are being met.

Indication of system failure:

Standing water over sub-grade soils at the bottom of the underground vault / chamber (72 hours after a storm event) typically indicates system failure. Long term system failures are generally the result of inadequate / improper O&M procedures within the

up-gradient sediment / trash removal devices, and / or within the underground vault / chamber system itself.

Drawdown times that exceed 72 hours are indicative of sub-grade clogging, and will (likely) require the removal of contaminants and raking of the sub-grade soils. The actual depth of removal can be done visually by looking at the discoloration of the entrapped fine silts, hydrocarbons (greases, oils), and organic matter. If required, replacement sub-grade soils must meet the design specifications under the original permit authorization.

In addition to the sub-grade soils, other elements of the stormwater management system such as pipes, inlets, geotextile fabric, gravel, sediment / trash removal devices, etc., are to be inspected and repaired / replaced if needed.

#### Sub-grade Soil Maintenance

The sub-grade soils at the bottom of this system are the only mechanism to provide water quality treatment (soil infiltration of the RTV). Therefore, the designed hydraulic conductivity rates within this soil must be maintained. Inspection ports and access manholes / trench grates are provided to facilitate ongoing inspection and maintenance activities. Failure to repair inflow / outflow scour erosion damage, or to remove detrimental materials (i.e., trash, clays, limerock debris, organic matter, etc.), will result in lower soil hydraulic conductivity rates, and subsequent system failure. Manual methods can be utilized for this required maintenance. However, the use of a vacuum truck for contaminate removal may be a more practical means of providing for the removal of these detrimental materials and sediments. Disposal of these contaminants shall be in an approved landfill facility.

#### Access Portals

All security and access features of the underground system should be checked periodically. Access manholes and trench grates should have secure bolted lids and grates to prevent unauthorized access to the underground system. If applicable, the associated ladder rungs will need to be checked to ensure that they are securely anchored to the system's walls. When inspection ports or access manholes / grates are open for maintenance and inspection, the opening shall be protected by a temporary railing / barrier / cover, etc., to prevent an accidental fall through the opening, along with providing for a safe environment for maintenance personnel.

#### Confined Spaces

The working environment within the underground system is characterized as a "confined space." The appropriate Federal Occupational Safety and Health Administration (OSHA) requirements will need to be met during any activities where personnel are required to enter the underground system. At all points of entry into the underground system, warning signage shall be posted to ensure that individuals do not enter until the requisite safeguards have been put in place. Additional information regarding confined space issues can be found at the following web sites:

[http://www.osha.gov/pls/oshaweb/owadisp.show\\_document?p\\_table=standards&p\\_id=9797](http://www.osha.gov/pls/oshaweb/owadisp.show_document?p_table=standards&p_id=9797)

[http://www.osha.gov/pls/oshaweb/owadisp.show\\_document?p\\_id=9801&p\\_table=STANDARDS](http://www.osha.gov/pls/oshaweb/owadisp.show_document?p_id=9801&p_table=STANDARDS)

<http://www.osha-safety-training.net/CFS/confined.html>

<http://www.thefreelibrary.com/Confined+space+regulations+born+from+industry-a0153292457>

**(d) Corrective Maintenance**

Corrective maintenance is required on an emergency or non-routine basis to correct problems and restore permitted operational capabilities of the facility. Corrective maintenance is not done on a scheduled basis but on an as needed basis. Failure to promptly address a corrective maintenance problem may jeopardize the performance and integrity of the facility. It may also present a potential safety problem to those living adjacent to or downstream of the facility. Corrective maintenance activities include:

- Prompt repair or replacement of any failing structural components of the facility to restore proper functioning of the system and to prevent downstream property damage or problems. This includes any damage to embankments, slopes, inflows, or discharge structures,
- Prompt repair, restabilization, and revegetation of any areas where erosion is occurring to prevent proper operation of the stormwater treatment system.
- Prompt removal of accumulated sediment, trash, and debris that blocks components of the system and threatens or impairs the proper functioning of the system.
- Repair of fences that are required to limit public access to the system.
- Remediation and restoration of the system's design infiltration rate. This requires an assessment of why the infiltration rate has diminished – is it due to sediment accumulation, ground water mounding, or a change in water table elevations. If the system contains ponded water after the design drawdown period or if cattails or other wetland vegetation are growing within a retention facility, this is an indication that the system is not operating as designed and the infiltration rate needs to be restored.

## **32.0 OPERATION AND MAINTENANCE ENTITIES AND REQUIREMENTS FOR STORMWATER TREATMENT SYSTEMS**

**Issue: The DEP-WMD stormwater team will be focusing over the next few months on how to best address OM of stormwater treatment systems. We are seeking input on the frequency of inspections, the requirements for inspections, the frequency of recertifying whether a stormwater treatment system is operating as designed and permitted, and whether the recertification forms should be submitted to the Agency or retained by the permittee**

### **32.1 Responsibilities**

- (a) In accordance with Rule 62-347.095, F.A.C., upon completion of a system constructed in conformance with a permit issued under Part IV of Chapter 373, F.S., the system must be converted from the construction phase to an operation and maintenance phase.
- (b) Responsibility for operation and maintenance of a system permitted under Chapters 62-347, F.A.C., shall be an obligation for the life of the system for a single entity that wholly owns or controls the lands on which any component of the permitted system is located and which has the fiscal, legal, and logistical capability to perform operation and maintenance in accordance with Department rules and permit conditions.
- (c) Conversion of a permit from the construction to the operation and maintenance phase shall follow the procedures in subsections 62-347.095, F.A.C., and **Section 32.2** below.

### **32.2 Procedures for Requesting Conversion from the Construction Phase to the Operation and Maintenance Phase**

- (a) Permittees for all systems, must submit Form 62-347.900(4) “As-Built Certification by a Registered Professional,” in accordance with subsection 62-347.095(2), F.A.C. That notice shall serve to notify the Agency that the system is ready for inspection. The permittee shall, at the same time, in accordance with subsection 62-347.095(2), F.A.C., also submit Form 62-347.900(6), “Request for Conversion of Stormwater Treatment Permit Construction Phase to Operation and Maintenance Phase,” requesting conversion of the permit from the construction phase to the operation phase. The above forms shall be submitted to the Agency office that issued the permit. The submittal of the above referenced forms does not require a processing fee, and their review shall not require processing as a permit modification under Rule 62-347.100, F.A.C. The forms, including information on how to obtain them electronically, are contained in **Appendix G** of this Handbook.
- (b) The Agency will review both forms, schedule an inspection as needed, determine compliance with the provisions in **Sections 32.3 through 32.4, below**, and respond to the applicant as to acceptance or rejection of the request to convert the permit from the construction to the operation and maintenance phase.
- (c) Unless otherwise specified in the permit, the operation and maintenance phase of an individual permit shall not become effective if the Agency has determined that the permittee is not in substantial compliance with all the plans, terms, and conditions of the permit.
- (d) The permittee will remain liable for compliance with the terms of the permit for the life of the system, unless such permit is transferred in accordance with Rule 62-347.130, F.A.C.

Failure to follow these procedures may result in applicable enforcement action.

### **32.3 Legal Operation and Maintenance Entities**

**32.3.1** (a) The following public entities do not need to provide financial responsibility mechanisms to ensure that a stormwater treatment system will be operated and routine custodial maintenance will be performed in compliance with the requirements of Chapter 62-347, F.A.C. However, a final letter of acceptance by the authorized entity representing the public entity is required before the operation phase can become effective. This documentation must clearly indicate what portions of the stormwater system will be maintained by the public entity.

1. Local governmental units including counties and municipalities, Municipal Service Taxing Units, or special service districts;
2. Active water control districts created pursuant to Chapter 298, F.S., drainage districts created by special act, special districts defined in Chapter 189, F.S., Community Development District created pursuant to Chapter 190, F.S., Special Assessment Districts created pursuant to Chapter 170, F.S., or water management districts created pursuant to Chapter 373, F.S.;
3. State or federal agencies;
4. Duly constituted communication, water, sewer, stormwater, electrical, or other public utilities;

(b) Non-governmental entities, such as profit or non-profit corporations, developers, property owner's and homeowner's associations, or master associations shall provide financial responsibility for operation and maintenance of the stormwater treatment system in an amount sufficient to operate and maintain the system for a minimum period of 10 years, as follows:

1. The applicant shall provide draft documentation of the required financial responsibility mechanisms described below with the permit application and shall submit the executed or finalized documentation prior to the operation phase becoming effective. Acceptable financial responsibility mechanisms are limited to an irrevocable letter of credit and standby trust fund, or fully funded trust. The financial responsibility mechanism shall be perpetual in nature and shall be payable at the direction of the Agency to its designee or to the standing trust fund.
2. All financial mechanisms must guarantee that the permittee will perform all of its obligations under the permit, provide alternative financial assurance of a type allowed by this section, and obtain the Agency's written approval of the alternative assurance provided within 90 days after receipt by both the permittee and the Agency of a notice of cancellation of a letter of credit or intent not to extend the expiration date of a letter of credit.
3. The amount of financial responsibility shall be sufficient to operate and maintain the system for a period of at least 10 years, and can be estimated in current dollars by the appropriate registered professional whose license authority in the State of Florida includes the ability to provide such certified written estimates.
4. The provisions of section 12.3.1(b) shall apply to all modifications of permits, as applicable.

(c) Both governmental and non-governmental entities shall provide proof to the Department that the entity has the legal authority to enter the property on which the system is located and to maintain the system.



**32.3.2** Non-governmental entities, such as profit or non-profit corporations, developers, property owners and homeowners associations, or master associations, are acceptable operation and maintenance entities only if they have the financial, legal, and administrative capability to provide for the long term operation and routine custodial maintenance of the surface water management system. The operating and maintenance entity must comply with the following provisions:

- (a) Corporate applicants must submit organizational or operation documents, or draft amendments thereto, that affirmatively assign responsibility for the operation or routine custodial maintenance of the surface water management system. These documents must be submitted to the Agency as part of the permit application. Model language for Operation and Maintenance documents is included in **Appendix G of this Handbook**.
- (b) The operating and maintenance entity must have sufficient powers (reflected in its organizational or operational documents where applicable) to:
  - 1. Own and convey property;
  - 2. Operate and perform routine custodial maintenance of the stormwater management system as exempted or permitted by the Agency;
  - 3. Establish rules and regulations governing membership or take any other actions necessary for the purposes for which the corporation or association was organized;
  - 4. Assess members for the cost of operating and maintaining the system, and enforce the collection of such assessments;
  - 5. Demonstrate that it has the authority to sue and be sued;
  - 6. Contract for services to provide for operation and routine custodial maintenance (if the association contemplates employing a maintenance company);
  - 7. Require all owners of real property or units to be members of the corporation or association;
  - 8. Demonstrate that the land on which the stormwater management system is located is owned or otherwise controlled by the corporation or association to the extent necessary to operate and maintain the system or convey operation and maintenance to another entity; and
  - 9. Provide that if the operating and maintenance entity dies, terminates, or is dissolved, the stormwater management system shall be transferred to and maintained by an entity meeting the requirements in **paragraphs 32.3.1(a) or (b), and paragraphs 32.3.2(a) and (b)1. through 8., above**, prior to its dissolution.

**32.3.3** If an operation and maintenance entity is proposed for a project which will be constructed in phases, and subsequent phases will use the same stormwater treatment system as the initial phase or phases, the entity must have the ability to accept responsibility for the operation and routine custodial maintenance of the stormwater treatment system for future phases of the project. If the development scheme contemplates independent operation and maintenance entities for different phases, and the system is integrated throughout the project, the entities, either separately or collectively, must have the responsibility and authority to operate and perform routine custodial maintenance of the system for the entire project area. That authority must include cross easements for stormwater treatment and the ability to enter and maintain the various works, should any subentity fail to maintain a portion of the system within the project area.

**32.3.4** When the applicant intends to convey the property to multiple third parties, the applicant will be an approved operation and maintenance entity from the time construction begins until the system is dedicated to and accepted by an established legal entity as described in **paragraphs 32.3.1(a) or (b), and paragraphs 32.3.2(a) and (b), above** will exist when construction of the system is

complete, and of the future acceptance of the system by such entity.

## **32.4 Minimum Operation and Maintenance Standards.**

### **(a) Maintenance Access**

Regular maintenance is crucial to the long-term effectiveness of stormwater treatment systems. Such systems must be designed to allow personnel and equipment access and to accommodate regular maintenance activities. For example, high maintenance features such as inlets, outlets, and pumps should be easily accessible to maintenance equipment and personnel.

Legal authorization, such as an easement, deed restrictions, or other instrument must be provided establishing a right-of-way or access for maintenance of the stormwater treatment system unless the operation and maintenance entity wholly owns or retains ownership of the property. The following are requirements for specific types of maintenance access easements:

- (1) Easements must cover at least the primary and high maintenance components of the system (i.e., inlets, outlets, littoral zones, filters, pumps, etc.), including provisions for equipment to enter and perform the necessary maintenance on the system. Applicants may propose site-specific easements that meet this requirement, or easements that meet the criteria in **Sections 32.4(b), (c), (d), or (e), below**, are allowed.
- (2) Easements for waterbodies, open conveyance systems, stormwater basins, and storage areas that:
  - a. Include the area of the water surface measured at the control elevation;
  - b. Extend a minimum of 20 feet from the top of bank and include side slopes or an allowance for side slopes calculated at no steeper than 4H:1V (horizontal to vertical), whichever is greater, and
  - c. Are traversable by maintenance equipment.
- (3) Easements adjacent to water control structures must be a minimum of 20 feet wide.
- (4) Easements for piped stormwater conveyance must be a minimum of the width of the pipe plus 4 times the depth of the pipe invert below finished grade.
- (5) Access easements that are 20 feet wide from a public road or public right-of-way to the stormwater management system.

### **(b) Operation and Maintenance General Requirements**

All stormwater treatment systems permitted by the Agency shall be operated and maintained in accordance with the designs, plans, calculations, and other specifications that are submitted with an application, approved by the Agency, and incorporated by reference or as a condition into any permit issued. Specific maintenance activities for various stormwater treatment BMPs are set forth in each BMP section of this Handbook. During inspections, special attention should be made to insure that:

1. All erosion is controlled and soil is stabilized to prevent sediment discharge to waters in the state.
2. The stormwater treatment system is kept free of debris, trash, garbage, oils and greases, and other refuse.
3. Engineered stormwater treatment systems that include oil and grease separators, skimmers, or collection devices are working properly and do not allow the discharge of oils or greases. Oils and greases or other materials removed from such a device during

- routine maintenance shall be disposed of at a sanitary landfill or by other lawful means.
4. All structures within engineered stormwater treatment systems have not become clogged or choked with vegetative or aquatic growth to such an extent as to render them inoperable.

**(c) Inspection Frequency**

All stormwater treatment systems shall be inspected annually to assure they are operating in accordance with permit requirements

**32.5 Reporting and Recertification.**

The results of all such inspections shall be available for inspection and review by the permitting Agency. In addition, Form 62-347.900(8), “Operation and Maintenance Inspection Certification,” shall be submitted to the permitting Agency annually for the first two years of operation. In subsequent years, recertification using this form shall be done in accordance with the schedule below:

<b>TYPE OF STORMWATER TREATMENT SYSTEM</b>	<b>DURING THE FIRST TWO YEARS OF OPERATION</b>	<b>AFTER THE FIRST TWO YEARS OF SUCCESSFUL OPERATION</b>
Retention basins	Annually	Once every 5 years
Exfiltration trenches	Annually	Once every 18 months? 24 months?
Underground retention	Annually	Once every 18 months? 24 months?
Underground vault/chambers	Annually	Once every 18 months? 24 months?
Swales	Annually	Once every 5 years
Vegetated Natural Buffers	Annually	Once every 18 months? 24 months?
Pervious pavements	Annually	Once every 18 months? 24 months?
Greenroof/cisterns	Annually	Once every 18 months? 24 months?
Wet detention basins	Annually	Once every 5 years
Managed aquatic plant systems	Annually	Once every 18 months? 24 months?
Stormwater harvesting	Annually	Once every 18 months? 24 months?
Wetland treatment trains	Annually	Once every 5 years
Underdrain filtration	Annually	Once every 18 months? 24 months?
Low impact design	Annually	Once every 18 months? 24 months?
Alum injection	Annually	Once every 18 months? 24 months?

This report describes the results of the inspections and certifies that the system is operating as designed and permitted. The report shall be filed within 30 days after the inspection. However, a

report also shall be submitted within 30 days of any system failure or deviation from the permit.

### **32.6 Recording of Easements, Deed Restrictions, and other Operation and Maintenance Documents.**

In accordance with subsection 62-347.095(5), F.A.C., for those systems that will be operated and maintained by an entity that requires an easement or deed restriction in order to operate and maintain the system, such easement or deed restriction, together with any other final operation and maintenance documents required by **section 32.3.2, above**, must be submitted to the Agency for approval. Deed restrictions, easements, and other operation and maintenance documents that require recordation with the Clerk of the Circuit Court must be recorded in the county where the project is located prior to any lot or unit sales within the project served by the system, or upon completion of construction of the system, whichever occurs first. For those systems that are to be operated and maintained by county or municipal entities, final operation and maintenance documents must be received by the Agency when maintenance and operation of the system is accepted by the local government entity. Failure to submit the appropriate final documents will result in the permittee remaining liable for carrying out maintenance and operation of the permitted system.

### **32.7 Subsequent Transfers**

In accordance with subsection 62-347.130, F.A.C., subsequent to the initial transfer of the permit to the operation and maintenance entity approved when the permit was issued, if the permittee wishes to request transfer of the operation and maintenance phase of the permit to another entity, the permittee must submit Form 62-347.900(7), "Notification of Transfer of Permit" to the Department as a modification to the permit, using the procedures in Rules 62-347.100 and 62-347.130, F.A.C. Until the permit is so transferred, the permittee shall be liable for compliance with all of the terms of the permit for the life of the system. Failure to follow these procedures may result in applicable enforcement action.

**APPENDIX A**  
**OTHER RULE & STATUTORY REFERENCES RELATED TO THIS HANDBOOK**

**NOTE: This Appendix will not be adopted in the stormwater rule**

**DEFINITIONS**

From Chapters 373 and 403, Florida Statutes:

- “Alter” or “Alteration” means to extend a dam or works beyond maintenance in its original condition, including changes which may increase or diminish the flow or storage of surface water which may affect the safety of such dam or works [Section 373.403(7), F.S.]
- “Appurtenant Work” means any artificial improvements to a dam, which affect the safety of such dam or, when employed, affect the holding capacity of such dam or of the reservoir or impoundment created by such dam. [Section 373.403(2), F.S.]
- “Canal” means a trench, the bottom of which is normally covered by water, with the upper edges of its two sides normally above water. [Section 403.803(2), F.S., and subsection 62-341.021(2), F.A.C.]
- “Channel” means a trench, the bottom of which is normally covered entirely by water, with the upper edges of one or both of its sides normally below water. [Section 403.803(3), F.S., and subsection 62-341.021(4), F.A.C.]
- “Closed System” means any reservoir or works located entirely within agricultural lands owned or controlled by the user and which requires water only for the filling, replenishing, and maintaining the water level thereof [Section 373.403(6), F.S.]
- “Coral” means living stony coral and soft coral. [subsection 62-341.021(3), F.A.C.]
- “Dam” means any artificial or natural barrier, with appurtenant works, raised to obstruct or impound, or which does obstruct or impound, any of the surface waters of the state [Section 373.403(1), F.S.]
- “Drainage basin” means a subdivision of a watershed [Section 373.403(9), F.S.].
- “Drainage ditch” or “irrigation ditch” means a man-made trench that is dug for the purpose of draining water from the land or for transporting water for use on the land and that is not built for navigational purposes. [Section 403.803(7), F.S., and subsection 62-341.021(6), F.A.C.]
- “Dredging” means excavation, by any means, in surface waters or wetlands, as delineated in Section 373.421(1), F.S. Excavation also means the excavation, or creation, of a water body which is, or is to be, connected to surface waters or wetlands, as delineated in Section 373.421(1), F.S., directly or via an excavated water body or series of water bodies [Section 373.403(13), F.S., and subsection 62-341.021(7), F.A.C.]
- “Ecological value” means the value of functions performed by uplands, wetlands and other surface waters to the abundance, diversity, and habitats of fish, wildlife, and listed species. These functions include, but are not limited to, providing cover and refuge; breeding, nesting, denning, and nursery areas; corridors for wildlife movement; food chain support; and natural water storage,

natural flow attenuation, and water quality improvement, which enhances fish, wildlife and listed species utilization. [Section 373.403(18), F.S.]

- ~~“Endangered species” means those animal species that are listed in Rule 68A-27.003, F.A.C., and those plant species that are listed as endangered in 50 Code of Federal Regulations 17.12 (1994). [subsection 62-341.021(8), F.A.C.]~~
- “Estuary” means a semi-enclosed, naturally existing coastal body of water which has a free connection with the open sea and within which seawater is measurably diluted with fresh water derived from riverine systems. [Section 373.403(15), F.S., and subsection 62-341.021(9), F.A.C.]
- “Filling” means the deposition, by any means, of materials in wetlands or other surface waters, as delineated in Section 373.421(1), F.S. [Section 373.403(14), F.S., and subsection 62-341.021(10), F.A.C.]
- “Ground water” means water beneath the surface of the ground, whether or not flowing through known and definite channels [Section 373.019(9), F.S.]
- “Impoundment” means any lake, reservoir, pond, or other containment of surface water occupying a bed or depression in the earth’s surface and having a discernible shoreline. [Sections 373.403(3) and 373.019(10), F.S.]
- “Insect control impoundment dikes” means artificial structures, including earthen berms, constructed and used to impound waters for the purpose of insect control. [Section 403.803(10), F.S.]
- “Lagoon” means a naturally existing coastal zone depression which is below mean high water and which has permanent or ephemeral communications with the sea, but which is protected from the sea by some type of naturally existing barrier. [Section 373.403(16), F.S., and subsection 62-341.021(13), F.A.C.]
- “Maintenance” or “Repairs” means remedial work of a nature as may affect the safety of any dam, impoundment, reservoir, or appurtenant work or works, but excludes routine custodial maintenance. [Section 373.403(8), F.S.]
- “Mitigation bank” means a project permitted under s. 373.4136 undertaken to provide for the withdrawal of mitigation credits to offset adverse impacts authorized by a permit under this part. [Section 373.403(19), F.S.]
- “Mitigation credit” means a standard unit of measure which represents the increase in ecological value resulting from restoration, enhancement, preservation, or creation activities. [Section 373.403(20), F.S.]
- “Mitigation service area” means the geographic area within which mitigation credits from a mitigation bank may be used to offset adverse impacts of activities regulated under this part. [Section 373.403(21), F.S.]
- “Offsite regional mitigation” means mitigation on an area of land off the site of an activity permitted under this part, where an applicant proposes to mitigate the adverse impacts of only the applicant’s specific activity as a requirement of the permit, which provides regional ecological value, and which is not a mitigation bank permitted under s. 373.4136. [Section 373.403(22), F.S.]

- “Other watercourse” means any canal, ditch, or other artificial watercourse in which water usually flows in a defined bed or channel. It is not essential that the flowing be uniform or uninterrupted. [Section 373.019(14), F.S.]
- “Pollution” is the presence in the outdoor atmosphere or waters of the state of any substances, contaminants, noise, or manmade or human-induced impairment of air or waters or alteration of the chemical, physical, biological, or radiological integrity of air or water in quantities or at levels which are or may be potentially harmful or injurious to human health or welfare, animal or plant life, or property or which unreasonably interfere with the enjoyment of life or property, including outdoor recreation unless authorized by applicable law. [Section 403.031(7), F.S.]
- “Reservoir” means any artificial or natural holding area that contains or will contain the water impounded by a dam. [Section 373.403(4), F.S.]
- “Riprap” means a sloping retaining structure or stabilization made to reduce the force of waves and to protect the shore from erosion, and consists of unconsolidated boulders, rocks, or clean concrete rubble with no exposed reinforcing rods or similar protrusions. [subsection 62-341.021(15), F.A.C.]
- “Seawall” means a man-made wall or encroachment, except riprap, which is made to break the force of waves and to protect the shore from erosion. [Section 373.403(17), F.S., and subsection 62-341.021(16), F.A.C.]
- “Species of special concern” means those species listed in Rule 68A-27.005, F.A.C. [subsection 62-341.021(17), F.A.C.]
- "State water quality standards" means water quality standards adopted pursuant to chapter 403. [Section 373.403(11), F.S.]
- “Stormwater management system” means a system that is designed and constructed or implemented to control discharges which are necessitated by rainfall events, incorporating methods to collect, convey, store, absorb, inhibit, treat, use, or reuse water to prevent or reduce flooding, overdrainage, environmental degradation, and water pollution or otherwise affect the quantity and quality of discharges from the system. [Sections 373.403(10) and 403.031(16), F.S.]
- “Stream” means any river, creek, slough, or natural watercourse in which water usually flows in a defined bed or channel. It is not essential that the flowing be uniform or uninterrupted. The fact that some part of the bed or channel shall have been dredged or improved does not prevent the watercourse from being a stream. [Section 373.019(18), F.S.]
- “Submerged grassbeds” means any native, herbaceous, submerged vascular plant community that is growing on the bottoms of surface waters waterward of the mean high water line or ordinary high water line. [subsection 62-341.021(18), F.A.C.]
- “Surface water” means water upon the surface of the earth, whether contained in bounds created naturally or artificially or diffused. Water from natural springs shall be classified as surface water when it exits from the spring onto the earth’s surface. [Section 373.019(19), F.S.]
- “Swale means a manmade trench which:

1. Has a top width to depth ratio of the cross-section equal to or greater than 6:1, or side slopes equal to or flatter than 3 feet horizontal to 1-foot vertical;
  2. Contains contiguous areas of standing or flowing water only following a rainfall event;
  3. Is planted with or has stabilized vegetation suitable for soil stabilization, stormwater treatment, and nutrient uptake; and
  4. Is designed to take into account the soil erodibility, soil percolation, slope, slope length, and drainage area so as to prevent erosion and reduce pollutant concentration of any discharge. [Section 403.803(14), F.S., and subsection 62-341.021(19), F.A.C.]
- “Vertical seawall” is a seawall the waterward face of which is at a slope steeper than 75 degrees to the horizontal. A seawall with sloping riprap covering the waterward face to the mean high water line shall not be considered a vertical seawall. [subsection 62-341.021(21), F.A.C.]
  - “Water” or “waters in the state” means any and all water on or beneath the surface of the ground or in the atmosphere, including natural or artificial watercourses, lakes, ponds, or diffused surface water and water percolating, standing, or flowing beneath the surface of the ground, as well as all coastal waters within the jurisdiction of the state. [Section 373.019(20), F.S.]
  - “Waters” shall be as defined in Section 403.031(13), F.S.
  - “Watershed” means the land area that contributes to the flow of water into a receiving body of water. [Sections 373.403(12) and 403.031(18), F.S.]
  - “Wetlands” shall be as defined in Section 373.019, F.S., the landward extent of which are delineated pursuant to Rules 62-340.100 through 62-340.550, F.A.C., as ratified by Section 373.4211, F.S.
  - “Works” means all artificial structures such as canals, conduits, channels, culverts, pipes, and other construction that connects to, draws water from, drains water into, or is placed in or across the waters in the state. [Section 373.403(5), F.S.]
  - “Works of the district” means those projects and works, including, but not limited to, structures, impoundments, wells, streams, and other watercourses, together with the appurtenant facilities and accompanying lands, which have been officially adopted by the governing board of the district as works of the district. [Section 373.019(26), F.S.]



From Rule 62-40.210, F.A.C. (Selected Definitions):

- (1) “Aquifer” shall mean a geologic formation, group of formations, or part of a formation that contains sufficient saturated permeable material to yield useful quantities of ground water to wells, springs or surface water.
- (4) “Consumptive use means any use of water which reduces the supply from which it is withdrawn or diverted.
- (6) “Designated use” means the present and future most beneficial use of a body of water pursuant to the water quality classification system in Rule 62-302.400, F.A.C.
- (7) “Detention” means the delay of stormwater runoff prior to its discharge.
- (8) “District” means a water management district created pursuant to Section 373.069, F.S.
- (11) “Floodplain” means land area subject to inundation by flood waters from a river, watercourse, lake, or coastal waters. Floodplains are delineated according to their estimated frequency of flooding.
- (12) “Florida Water Plan” means the state-level water resource plan developed by the Department under Section 373.036, F.S.
- (13) “Governing Board” means the governing board of a water management district created under Section 373.069, F.S.
- (14) “Ground water” means water beneath the surface of the ground, whether or not flowing through known and definite channels.
- (15) “Ground water basin” means a ground water flow system that has defined boundaries and may include permeable materials that are capable of storing or furnishing a significant water supply. The basin includes both the surface area and the permeable materials beneath it.
- (16) “High recharge areas” means areas contributing significant volumes of water which add to the storage and flow of an aquifer through vertical movement from the land surface. The term significant will vary geographically depending on the hydrologic characteristics of that aquifer.
- (18) “Impaired water” means a water body or water body segment that does not meet one or more of its designated uses due in whole or in part to discharges of pollutants, and has been listed as impaired by order of the Secretary in accordance with the procedures set forth in Chapter 62-303, F.A.C.
- (19) “Natural systems” for the purpose of this rule means an ecological system supporting aquatic and wetland-dependent natural resources, including fish and aquatic and wetland-dependent wildlife habitat.
- (20) “Pollutant load reduction goal,” or PLRG, means estimated numeric reductions in pollutant loadings, usually established in a Surface Water Improvement and Management or other watershed management plan, that are needed to preserve or restore designated uses of receiving bodies of water and maintain water quality consistent with applicable state water quality

standards. In some cases, PLRGs may provide the scientific basis for the development of a Total Maximum Daily Load.

- (22) “Prime recharge areas” means areas that are generally within high recharge areas and are significant to present and future ground water uses including protection and maintenance of natural systems and water supply.
- (25) “Reclaimed water,” except as specifically provided in Chapter 62-610, F.A.C., means water that has received at least secondary treatment and basic disinfection, and is reused after flowing out of a domestic wastewater treatment facility.
- (27) “Retention” means the prevention of stormwater runoff from direct discharge.
- (28) “Reuse” means the deliberate application of reclaimed water, in compliance with Department and District rules, for a beneficial purpose.
- (30) “Secretary” means the Secretary of the Department of Environmental Protection.
- (31) “State water quality standards” means water quality standards adopted by the Environmental Regulation Commission pursuant to Chapter 403, F.S., including standards composed of designated most beneficial uses (classification of waters), the numerical and narrative criteria applied to the specific water use or classification, the Florida anti-degradation policy (Rules 62-4.242 and 62-302.300, F.A.C.), and the moderating provisions contained in Chapters 62-4, 62-302, 62-520, and 62-550, F.A.C.
- (32) “Stormwater” means the water that results from a rainfall event.
- (33) “Stormwater management program” means the institutional strategy for stormwater management, including urban, agricultural, and other stormwater.
- (34) “Stormwater management system” means a system which is designed and constructed or implemented to control stormwater, incorporating methods to collect, convey, store, absorb, inhibit, treat, use, or reuse stormwater to prevent or reduce flooding, over-drainage, environmental degradation and water pollution or otherwise affect the quantity and quality of discharges from the system.
- (35) “Stormwater recycling” means capturing stormwater for irrigation or other beneficial use.
- (36) “Stormwater utility” means the entity through which funding for a stormwater management program is obtained by assessing the cost of the program to the beneficiaries based on their relative contribution to its need. It is operated as a typical utility that bills services regularly, similar to water and wastewater services.
- (37) “Surface water” means water upon the surface of the earth, whether contained in bounds created naturally or artificially or diffused. Water from natural springs shall be classified as surface water when it exits from the spring onto the earth’s surface.
- (38) “Total maximum daily load,” or TMDL, means the sum of the individual wasteload allocations for point sources and the load allocations for nonpoint sources and natural background. Prior to determining individual wasteload allocations and load allocations, the maximum amount of a

pollutant that a water body or water segment can assimilate from all sources without exceeding water quality standards must first be calculated.

- (39) “Water resource caution area” means a geographic area identified by a District as having existing water resource problems or an area in which water resource problems are projected to develop during the next twenty years.
- (40) “Water” or “waters in the state” means any and all water on or beneath the surface of the ground or in the atmosphere, including natural or artificial watercourses, lakes, ponds, or diffused surface water and water percolating, standing, or flowing beneath the surface of the ground, as well as all coastal waters within the jurisdiction of the state.
- (41) “Watershed” means the land area that contributes to the flow of water into a receiving body of water.
- (42) “Watershed management goal” means an overall goal for the management of water resources within a watershed.

From Rule 62-340.200, F.A.C. (Selected Definitions):

- (1) “Aquatic plant” means a plant, including the roots, which typically floats on water or requires water for its entire structural support, or which will desiccate outside of water.
- (2) “Canopy” means the plant stratum composed of all woody plants and palms with a trunk four inches or greater in diameter at breast height, except vines.
- (3) “Diameter at Breast Height (DBH)” means the diameter of a plant’s trunk or main stem at a height of 4.5 feet above the ground.
- (4) “Facultative plants” means those plant species listed in subsection 62-340.450(3), F.A.C., of this chapter. For the purposes of this rule, facultative plants are not indicators of either wetland or upland conditions.
- (5) “Facultative Wet plants” means those plant species listed in subsection 62-340.450(2), F.A.C., of this chapter.
- (6) “Ground Cover” means the plant stratum composed of all plants not found in the canopy or subcanopy, except vines and aquatic plants.
- (7) “Ground truthing” means verification on the ground of conditions on a site.
- (8) “Hydric Soils” means soils that are saturated, flooded, or ponded long enough during the growing season to develop anaerobic conditions in the upper part of the soil profile.
- (9) “Hydric Soil Indicators” means those indicators of hydric soil conditions as identified in *Soil and Water Relationships of Florida's Ecological Communities* (Florida Soil Conservation ed. Staff 1992).
- (10) “Inundation” means a condition in which water from any source regularly and periodically covers a land surface.

- (11) “Obligate plants” means those plant species listed in subsection 62-340.450(1), F.A.C., of this chapter.
- (12) “Regulating agency” means the Department of Environmental Protection, the water management districts, state or regional agencies, local governments, and any other governmental entities.
- (13) “Riverwash” means areas of unstabilized sandy, silty, clayey, or gravelly sediments. These areas are flooded, washed, and reworked by rivers or streams so frequently that they may support little or no vegetation.
- (14) “Saturation” means a water table six inches or less from the soil surface for soils with a permeability equal to or greater than six inches per hour in all layers within the upper 12 inches, or a water table 12 inches or less from the soil surface for soils with a permeability less than six inches per hour in any layer within the upper 12 inches.
- (15) “Seasonal High Water” means the elevation to which the ground and surface water can be expected to rise due to a normal wet season.
- (16) “Subcanopy” means the plant stratum composed of all woody plants and palms, exclusive of the canopy, with a trunk or main stem with a DBH between one and four inches, except vines.
- (17) “Upland plants” means those plant species, not listed as Obligate, Facultative Wet, or Facultative by this rule, excluding vines, aquatic plants, and any plant species not introduced into the State of Florida as of the effective date of this rule.
- (19) “Wetlands,” as defined in subsection 373.019(25)(47), F.S., means those areas that are inundated or saturated by surface water or ground water at a frequency and a duration sufficient to support, and under normal circumstances do support, a prevalence of vegetation typically adapted for life in saturated soils. Soils present in wetlands generally are classified as hydric or alluvial, or possess characteristics that are associated with reducing soil conditions. The prevalent vegetation in wetlands generally consists of facultative or obligate hydrophytic macrophytes that are typically adapted to areas having soil conditions described above. These species, due to morphological, physiological, or reproductive adaptations, have the ability to grow, reproduce or persist in aquatic environments or anaerobic soil conditions. Florida wetlands generally include swamps, marshes, bayheads, bogs, cypress domes and strands, sloughs, wet prairies, riverine swamps and marshes, hydric seepage slopes, tidal marshes, mangrove swamps and other similar areas. Florida wetlands generally do not include longleaf or slash pine flatwoods with an understory dominated by saw palmetto.

## EXEMPTIONS

From Section 373.406, Florida Statutes

The following exemptions shall apply:

- (1) Nothing herein, or in any rule, regulation, or order adopted pursuant hereto, shall be construed to affect the right of any natural person to capture, discharge, and use water for purposes permitted by law.
- (2) Nothing herein, or in any rule, regulation, or order adopted pursuant hereto, shall be construed to affect the right of any person engaged in the occupation of agriculture, silviculture, floriculture, or horticulture to alter the topography of any tract of land for purposes consistent with the practice of such occupation. However, such alteration may not be for the sole or predominant purpose of impounding or obstructing surface waters.
- (3) Nothing herein, or in any rule, regulation, or order adopted pursuant hereto, shall be construed to be applicable to construction, operation, or maintenance of any agricultural closed system. However, part II of this chapter shall be applicable as to the taking and discharging of water for filling, replenishing, and maintaining the water level in any such agricultural closed system. This subsection shall not be construed to eliminate the necessity to meet generally accepted engineering practices for construction, operation, and maintenance of dams, dikes, or levees.
- (4) All rights and restrictions set forth in this section shall be enforced by the governing board or the Department of Environmental Protection or its successor agency, and nothing contained herein shall be construed to establish a basis for a cause of action for private litigants.
- (5) The department or the governing board may by rule establish general permits for stormwater management systems which have, either singularly or cumulatively, minimal environmental impact. The department or the governing board also may establish by rule exemptions or general permits that implement interagency agreements entered into pursuant to s. 373.046, s. 378.202, s. 378.205, or s. 378.402.
- (6) Any district or the department may exempt from regulation under this part those activities that the district or department determines will have only minimal or insignificant individual or cumulative adverse impacts on the water resources of the district. The district and the department are authorized to determine, on a case-by-case basis, whether a specific activity comes within this exemption. Requests to qualify for this exemption shall be submitted in writing to the district or department, and such activities shall not be commenced without a written determination from the district or department confirming that the activity qualifies for the exemption.
- (7) Nothing in this part, or in any rule or order adopted under this part, may be construed to require a permit for mining activities for which an operator receives a life-of-the-mine permit under s. 378.901.
- (8) Certified aquaculture activities which apply appropriate best management practices adopted pursuant to s. 597.004 are exempt from this part.
- (9) Implementation of measures having the primary purpose of environmental restoration or water quality improvement on agricultural lands are exempt from regulation under this part where these

measures or practices are determined by the district or department, on a case-by-case basis, to have minimal or insignificant individual and cumulative adverse impact on the water resources of the state. The district or department shall provide written notification as to whether the proposed activity qualifies for the exemption within 30 days after receipt of a written notice requesting the exemption. No activity under this exemption shall commence until the district or department has provided written notice that the activity qualifies for the exemption.

- (10) Implementation of interim measures or best management practices adopted pursuant to s. 403.067 that are by rule designated as having minimal individual or cumulative adverse impacts to the water resources of the state are exempt from regulation under this part.
- (11) Any district or the department may adopt rules to exempt from regulation under this part any system for a mining or mining-related activity that is described in or covered by an exemption confirmation letter issued by the district pursuant to applicable rules implementing this part that were in effect at the time the letter was issued, and that will not be harmful to the water resources. Such rules may include provisions for the duration of this exemption.

From Section 403.813(1), Florida Statutes:

A permit is not required under this chapter, chapter 373, chapter 61-691, Laws of Florida, or chapter 25214 or chapter 25270, 1949, Laws of Florida, for activities associated with the following types of projects; however, except as otherwise provided in this subsection, nothing in this subsection relieves an applicant from any requirement to obtain permission to use or occupy lands owned by the Board of Trustees of the Internal Improvement Trust Fund or any water management district in its governmental or proprietary capacity or from complying with applicable local pollution control programs authorized under this chapter or other requirements of county and municipal governments:

- (a) The installation of overhead transmission lines, with support structures which are not constructed in waters of the state and which do not create a navigational hazard.
- (b) The installation and repair of mooring pilings and dolphins associated with private docking facilities or piers and the installation of private docks, piers and recreational docking facilities, or piers and recreational docking facilities of local governmental entities when the local governmental entity's activities will not take place in any manatee habitat, any of which docks:
  - 1. Has 500 square feet or less of over-water surface area for a dock which is located in an area designated as Outstanding Florida Waters or 1,000 square feet or less of over-water surface area for a dock which is located in an area which is not designated as Outstanding Florida Waters;
  - 2. Is constructed on or held in place by pilings or is a floating dock which is constructed so as not to involve filling or dredging other than that necessary to install the pilings;
  - 3. Shall not substantially impede the flow of water or create a navigational hazard;
  - 4. Is used for recreational, noncommercial activities associated with the mooring or storage of boats and boat paraphernalia; and

5. Is the sole dock constructed pursuant to this exemption as measured along the shoreline for a distance of 65 feet, unless the parcel of land or individual lot as platted is less than 65 feet in length along the shoreline, in which case there may be one exempt dock allowed per parcel or lot.

Nothing in this paragraph shall prohibit the department from taking appropriate enforcement action pursuant to this chapter to abate or prohibit any activity otherwise exempt from permitting pursuant to this paragraph if the department can demonstrate that the exempted activity has caused water pollution in violation of this chapter.

- (c) The installation and maintenance to design specifications of boat ramps on artificial bodies of water where navigational access to the proposed ramp exists or the installation of boat ramps open to the public in any waters of the state where navigational access to the proposed ramp exists and where the construction of the proposed ramp will be less than 30 feet wide and will involve the removal of less than 25 cubic yards of material from the waters of the state, and the maintenance to design specifications of such ramps; however, the material to be removed shall be placed upon a self-contained upland site so as to prevent the escape of the spoil material into the waters of the state.
- (d) The replacement or repair of existing docks and piers, except that no fill material is to be used and provided that the replacement or repaired dock or pier is in the same location and of the same configuration and dimensions as the dock or pier being replaced or repaired.
- (e) The restoration of seawalls at their previous locations or upland of, or within 1 foot waterward of, their previous locations. However, this shall not affect the permitting requirements of chapter 161, and department rules shall clearly indicate that this exception does not constitute an exception from the permitting requirements of chapter 161.
- (f) The performance of maintenance dredging of existing manmade canals, channels, intake and discharge structures, and previously dredged portions of natural water bodies within drainage rights-of-way or drainage easements which have been recorded in the public records of the county, where the spoil material is to be removed and deposited on a self-contained, upland spoil site which will prevent the escape of the spoil material into the waters of the state, provided that no more dredging is to be performed than is necessary to restore the canals, channels, and intake and discharge structures, and previously dredged portions of natural water bodies, to original design specifications or configurations, provided that the work is conducted in compliance with s. ~~379.2431(2)(d)~~ ~~370.12(2)(d)~~, provided that no significant impacts occur to previously undisturbed natural areas, and provided that control devices for return flow and best management practices for erosion and sediment control are utilized to prevent bank erosion and scouring and to prevent turbidity, dredged material, and toxic or deleterious substances from discharging into adjacent waters during maintenance dredging. Further, for maintenance dredging of previously dredged portions of natural water bodies within recorded drainage rights-of-way or drainage easements, an entity that seeks an exemption must notify the department or water management district, as applicable, at least 30 days prior to dredging and provide documentation of original design specifications or configurations where such exist. This exemption applies to all canals and previously dredged portions of natural water bodies within recorded drainage rights-of-way or drainage easements constructed prior to April 3, 1970, and to those canals and previously dredged portions of natural water bodies constructed on or after April 3, 1970, pursuant to all necessary state permits. This exemption does not apply to the removal of a natural or manmade barrier separating a canal or canal system from adjacent waters. When no previous permit has been

issued by the Board of Trustees of the Internal Improvement Trust Fund or the United States Army Corps of Engineers for construction or maintenance dredging of the existing manmade canal or intake or discharge structure, such maintenance dredging shall be limited to a depth of no more than 5 feet below mean low water. The Board of Trustees of the Internal Improvement Trust Fund may fix and recover from the permittee an amount equal to the difference between the fair market value and the actual cost of the maintenance dredging for material removed during such maintenance dredging. However, no charge shall be exacted by the state for material removed during such maintenance dredging by a public port authority. The removing party may subsequently sell such material; however, proceeds from such sale that exceed the costs of maintenance dredging shall be remitted to the state and deposited in the Internal Improvement Trust Fund.

- (g) The maintenance of existing insect control structures, dikes, and irrigation and drainage ditches, provided that spoil material is deposited on a self-contained, upland spoil site which will prevent the escape of the spoil material into waters of the state. In the case of insect control structures, if the cost of using a self-contained upland spoil site is so excessive, as determined by the Department of Health, pursuant to s. 403.088(1), that it will inhibit proposed insect control, then-existing spoil sites or dikes may be used, upon notification to the department. In the case of insect control where upland spoil sites are not used pursuant to this exemption, turbidity control devices shall be used to confine the spoil material discharge to that area previously disturbed when the receiving body of water is used as a potable water supply, is designated as shellfish harvesting waters, or functions as a habitat for commercially or recreationally important shellfish or finfish. In all cases, no more dredging is to be performed than is necessary to restore the dike or irrigation or drainage ditch to its original design specifications.
- (h) The repair or replacement of existing functional pipes or culverts the purpose of which is the discharge or conveyance of stormwater. In all cases, the invert elevation, the diameter, and the length of the culvert shall not be changed. However, the material used for the culvert may be different from the original.
- (i) The construction of private docks of 1,000 square feet or less of over-water surface area and seawalls in artificially created waterways where such construction will not violate existing water quality standards, impede navigation, or affect flood control. This exemption does not apply to the construction of vertical seawalls in estuaries or lagoons unless the proposed construction is within an existing manmade canal where the shoreline is currently occupied in whole or part by vertical seawalls.
- (j) The construction and maintenance of swales.
- (k) The installation of aids to navigation and buoys associated with such aids, provided the devices are marked pursuant to s. 327.40.
- (l) The replacement or repair of existing open-trestle foot bridges and vehicular bridges that are 100 feet or less in length and two lanes or less in width, provided that no more dredging or filling of submerged lands is performed other than that which is necessary to replace or repair pilings and that the structure to be replaced or repaired is the same length, the same configuration, and in the same location as the original bridge. No debris from the original bridge shall be allowed to remain in the waters of the state.



- (m) The installation of subaqueous transmission and distribution lines laid on, or embedded in, the bottoms of waters in the state, except in Class I and Class II waters and aquatic preserves, provided no dredging or filling is necessary.
- (n) The replacement or repair of subaqueous transmission and distribution lines laid on, or embedded in, the bottoms of waters of the state.
- (o) The construction of private seawalls in wetlands or other surface waters where such construction is between and adjoins at both ends existing seawalls; follows a continuous and uniform seawall construction line with the existing seawalls; is no more than 150 feet in length; and does not violate existing water quality standards, impede navigation, or affect flood control. However, in estuaries and lagoons the construction of vertical seawalls is limited to the circumstances and purposes stated in s. 373.414(5)(b)1.-4. This paragraph does not affect the permitting requirements of chapter 161, and department rules must clearly indicate that this exception does not constitute an exception from the permitting requirements of chapter 161.
- (p) The restoration of existing insect control impoundment dikes which are less than 100 feet in length. Such impoundments shall be connected to tidally influenced waters for 6 months each year beginning September 1 and ending February 28 if feasible or operated in accordance with an impoundment management plan approved by the department. A dike restoration may involve no more dredging than is necessary to restore the dike to its original design specifications. For the purposes of this paragraph, restoration does not include maintenance of impoundment dikes of operating insect control impoundments.
- (q) The construction, operation, or maintenance of stormwater management facilities which are designed to serve single-family residential projects, including duplexes, triplexes, and quadruplexes, if they are less than 10 acres total land and have less than 2 acres of impervious surface and if the facilities:
  1. Comply with all regulations or ordinances applicable to stormwater management and adopted by a city or county;
  2. Are not part of a larger common plan of development or sale; and
  3. Discharge into a stormwater discharge facility exempted or permitted by the department under this chapter which has sufficient capacity and treatment capability as specified in this chapter and is owned, maintained, or operated by a city, county, special district with drainage responsibility, or water management district; however, this exemption does not authorize discharge to a facility without the facility owner's prior written consent.
- (r) The removal of aquatic plants, the removal of tussocks, the associated replanting of indigenous aquatic plants, and the associated removal from lakes of organic detrital material when such planting or removal is performed and authorized by permit or exemption granted under s. 369.20 or s. 369.25, provided that:
  1. Organic detrital material that exists on the surface of natural mineral substrate shall be allowed to be removed to a depth of 3 feet or to the natural mineral substrate, whichever is less;

2. All material removed pursuant to this paragraph shall be deposited in an upland site in a manner that will prevent the reintroduction of the material into waters in the state except when spoil material is permitted to be used to create wildlife islands in freshwater bodies of the state when a governmental entity is permitted pursuant to s. 369.20 to create such islands as a part of a restoration or enhancement project;
3. All activities are performed in a manner consistent with state water quality standards; and
4. No activities under this exemption are conducted in wetland areas, as defined by s. 373.019(25), which are supported by a natural soil as shown in applicable United States Department of Agriculture county soil surveys, except when a governmental entity is permitted pursuant to s. 369.20 to conduct such activities as a part of a restoration or enhancement project.

The department may not adopt implementing rules for this paragraph, notwithstanding any other provision of law.

- (s) The construction, installation, operation, or maintenance of floating vessel platforms or floating boat lifts, provided that such structures:
1. Float at all times in the water for the sole purpose of supporting a vessel so that the vessel is out of the water when not in use;
  2. Are wholly contained within a boat slip previously permitted under ss. 403.91-403.929, 1984 Supplement to the Florida Statutes 1983, as amended, or part IV of chapter 373, or do not exceed a combined total of 500 square feet, or 200 square feet in an Outstanding Florida Water, when associated with a dock that is exempt under this subsection or associated with a permitted dock with no defined boat slip or attached to a bulkhead on a parcel of land where there is no other docking structure;
  3. Are not used for any commercial purpose or for mooring vessels that remain in the water when not in use, and do not substantially impede the flow of water, create a navigational hazard, or unreasonably infringe upon the riparian rights of adjacent property owners, as defined in s. 253.141;
  4. Are constructed and used so as to minimize adverse impacts to submerged lands, wetlands, shellfish areas, aquatic plant and animal species, and other biological communities, including locating such structures in areas where seagrasses are least dense adjacent to the dock or bulkhead; and
  5. Are not constructed in areas specifically prohibited for boat mooring under conditions of a permit issued in accordance with ss. 403.91-403.929, 1984 Supplement to the Florida Statutes 1983, as amended, or part IV of chapter 373, or other form of authorization issued by a local government.

Structures that qualify for this exemption are relieved from any requirement to obtain permission to use or occupy lands owned by the Board of Trustees of the Internal Improvement Trust Fund and, with the exception of those structures attached to a bulkhead on a parcel of land where there is no docking structure, shall not be subject to any more stringent permitting requirements, registration requirements, or other regulation by any local government. Local governments may

require either permitting or one-time registration of floating vessel platforms to be attached to a bulkhead on a parcel of land where there is no other docking structure as necessary to ensure compliance with local ordinances, codes, or regulations. Local governments may require either permitting or one-time registration of all other floating vessel platforms as necessary to ensure compliance with the exemption criteria in this section; to ensure compliance with local ordinances, codes, or regulations relating to building or zoning, which are no more stringent than the exemption criteria in this section or address subjects other than subjects addressed by the exemption criteria in this section; and to ensure proper installation, maintenance, and precautionary or evacuation action following a tropical storm or hurricane watch of a floating vessel platform or floating boat lift that is proposed to be attached to a bulkhead or parcel of land where there is no other docking structure. The exemption provided in this paragraph shall be in addition to the exemption provided in paragraph (b). The department shall adopt a general permit by rule for the construction, installation, operation, or maintenance of those floating vessel platforms or floating boat lifts that do not qualify for the exemption provided in this paragraph but do not cause significant adverse impacts to occur individually or cumulatively. The issuance of such general permit shall also constitute permission to use or occupy lands owned by the Board of Trustees of the Internal Improvement Trust Fund. No local government shall impose a more stringent regulation, permitting requirement, registration requirement, or other regulation covered by such general permit. Local governments may require either permitting or one-time registration of floating vessel platforms as necessary to ensure compliance with the general permit in this section; to ensure compliance with local ordinances, codes, or regulations relating to building or zoning that are no more stringent than the general permit in this section; and to ensure proper installation and maintenance of a floating vessel platform or floating boat lift that is proposed to be attached to a bulkhead or parcel of land where there is no other docking structure.

- (t) The repair, stabilization, or paving of existing county maintained roads and the repair or replacement of bridges that are part of the roadway, within the Northwest Florida Water Management District and the Suwannee River Water Management District, provided:
1. The road and associated bridge were in existence and in use as a public road or bridge, and were maintained by the county as a public road or bridge on or before January 1, 2002;
  2. The construction activity does not realign the road or expand the number of existing traffic lanes of the existing road; however, the work may include the provision of safety shoulders, clearance of vegetation, and other work reasonably necessary to repair, stabilize, pave, or repave the road, provided that the work is constructed by generally accepted engineering standards;
  3. The construction activity does not expand the existing width of an existing vehicular bridge in excess of that reasonably necessary to properly connect the bridge with the road being repaired, stabilized, paved, or repaved to safely accommodate the traffic expected on the road, which may include expanding the width of the bridge to match the existing connected road. However, no debris from the original bridge shall be allowed to remain in waters of the state, including wetlands;
  4. Best management practices for erosion control shall be employed as necessary to prevent water quality violations;

5. Roadside swales or other effective means of stormwater treatment must be incorporated as part of the project;
6. No more dredging or filling of wetlands or water of the state is performed than that which is reasonably necessary to repair, stabilize, pave, or repave the road or to repair or replace the bridge, in accordance with generally accepted engineering standards; and
7. Notice of intent to use the exemption is provided to the department, if the work is to be performed within the Northwest Florida Water Management District, or to the Suwannee River Water Management District, if the work is to be performed within the Suwannee River Water Management District, 30 days prior to performing any work under the exemption.

Within 30 days after this act becomes a law, the department shall initiate rulemaking to adopt a no fee general permit for the repair, stabilization, or paving of existing roads that are maintained by the county and the repair or replacement of bridges that are part of the roadway where such activities do not cause significant adverse impacts to occur individually or cumulatively. The general permit shall apply statewide and, with no additional rulemaking required, apply to qualified projects reviewed by the Suwannee River Water Management District, the St. Johns River Water Management District, the Southwest Florida Water Management District, and the South Florida Water Management District under the division of responsibilities contained in the operating agreements applicable to part IV of chapter 373. Upon adoption, this general permit shall, pursuant to the provisions of subsection (3), supersede and replace the exemption in this paragraph.

- (u) Notwithstanding any provision to the contrary in this subsection, a permit or other authorization under chapter 253, chapter 369, chapter 373, or this chapter is not required for an individual residential property owner for the removal of organic detrital material from freshwater rivers or lakes that have a natural sand or rocky substrate and that are not Aquatic Preserves or for the associated removal and replanting of aquatic vegetation for the purpose of environmental enhancement, providing that:
1. No activities under this exemption are conducted in wetland areas, as defined by s. 373.019(25), which are supported by a natural soil as shown in applicable United States Department of Agriculture county soil surveys.
  2. No filling or peat mining is allowed.
  3. No removal of native wetland trees, including, but not limited to, ash, bay, cypress, gum, maple, or tupelo, occurs.
  4. When removing organic detrital material, no portion of the underlying natural mineral substrate or rocky substrate is removed.
  5. Organic detrital material and plant material removed is deposited in an upland site in a manner that will not cause water quality violations.
  6. All activities are conducted in such a manner, and with appropriate turbidity controls, so as to prevent any water quality violations outside the immediate work area.

7. Replanting with a variety of aquatic plants native to the state shall occur in a minimum of 25 percent of the preexisting vegetated areas where organic detrital material is removed, except for areas where the material is removed to bare rocky substrate; however, an area may be maintained clear of vegetation as an access corridor. The access corridor width may not exceed 50 percent of the property owner's frontage or 50 feet, whichever is less, and may be a sufficient length waterward to create a corridor to allow access for a boat or swimmer to reach open water. Replanting must be at a minimum density of 2 feet on center and be completed within 90 days after removal of existing aquatic vegetation, except that under dewatered conditions replanting must be completed within 90 days after reflooding. The area to be replanted must extend waterward from the ordinary high water line to a point where normal water depth would be 3 feet or the preexisting vegetation line, whichever is less. Individuals are required to make a reasonable effort to maintain planting density for a period of 6 months after replanting is complete, and the plants, including naturally recruited native aquatic plants, must be allowed to expand and fill in the revegetation area. Native aquatic plants to be used for revegetation must be salvaged from the enhancement project site or obtained from an aquatic plant nursery regulated by the Department of Agriculture and Consumer Services. Plants that are not native to the state may not be used for replanting.
8. No activity occurs any farther than 100 feet waterward of the ordinary high water line, and all activities must be designed and conducted in a manner that will not unreasonably restrict or infringe upon the riparian rights of adjacent upland riparian owners.
9. The person seeking this exemption notifies the applicable department district office in writing at least 30 days before commencing work and allows the department to conduct a preconstruction site inspection. Notice must include an organic-detrital-material removal and disposal plan and, if applicable, a vegetation-removal and revegetation plan.
10. The department is provided written certification of compliance with the terms and conditions of this paragraph within 30 days after completion of any activity occurring under this exemption.

## APPENDIX B CORRELATION OF NATURAL VEGETATIVE COMMUNITY TYPES WITH SOIL SERIES

To determine the TP and TN vegetation group, determine the soil type(s) on your site and find it in the table below. Some soils will only have one vegetative community while others may have several. If there is only one vegetative community for the soil on your site, use the listed TP and TN Vegetative Group for your predevelopment loading calculations. If there is more than one vegetative community for the soil on your site, you must determine which one or ones also exist on your site or are similar to those on your site. Finally, for soils that have a vegetative community listed as Mixed Hardwood/Pine or Turkey Oak/Longleaf Pine, you must determine which vegetative community is on your site and select the appropriate TP or TN Vegetative Group. In such cases, use the first number in each column for areas with mixed hardwood or turkey oak vegetation and the second number in each column for areas with pine vegetation. Wetland vegetative communities are not assigned a vegetation group since they are not included in loading calculations.

### EXAMPLES:

1. The site has Ankona soils which lists the vegetative community as South Florida Flatwoods which is in TP Vegetative Group 1 and in TN Vegetative Group 2.
2. The site has Adamsville soils which lists three possible vegetative communities. The site includes both flatwoods vegetation and hardwood forest. Therefore, the acres that are in flatwoods are in TP Vegetative Group 1 and in TN Vegetative Group 2, while the acres that are in hardwood forest are in TP Group 2 and TN Group 2.
3. The site has Alaga soils which lists Mixed Hardwood/Pine as the vegetative community. The site has both hardwood and pine forests. For the acres in hardwood forest, the TP Vegetative Group is 2 and the TN Group is 1, while the TP Vegetative Group is 1 and the TN Group is 1 for the acres in pine.

SOIL SERIES	VEGETATIVE COMMUNITY	STORMWATER RULE VEGETATIVE GROUP	
		TP	TN
Adamsville	6 - South Florida Flatwoods	1	2
	11 - Upland Hardwood Hammock	2	2
	15 - Oak Hammock	2	2
Adamsville thermic variants	7 - North Florida Flatwoods	1	2
	15 - Oak Hammock	2	2
Alaga	5 - Mixed Hardwood / Pine	2/1	1/1
Alapaha	11 - Wetland Hardwood Hammock	2	2
Allanton	21 - Swamp Hardwoods	2	2
Albany	5 - Mixed Hardwood and Pine	2/1	1/1
Alluvial	20 - Bottomland Hardwoods	2	2
	21 - Swamp Hardwoods	2	2
Alpin	4 - Turkey Oak / Longleaf Pine	2/1	1/1
Anclote	21 - Swamp Hardwoods	2	2
	26 - Slough		
Anclote, depressional	25 - Freshwater Marsh and Ponds		

SOIL SERIES	VEGETATIVE COMMUNITY	STORMWATER RULE VEGETATION GROUP	
		TP	TN
Anclote, Tomoka Association	21 - Swamp Hardwoods 25 - Freshwater Marsh and Ponds 26 - Slough	2	2
Angie	5 - Mixed Hardwood / Pine	2/1	1/1
Ankona	6 - South Florida Flatwoods	1	2
Ankona, depressional	25 - Freshwater Marsh and Ponds		
Apalachee	21 - Swamp Hardwoods	2	2
Apopka	4 - Turkey Oak / Longleaf Pine 11- Upland Hardwood Hammock	2/1 2	1/1 2
Archbold	3 - Sand Pine Scrub	1	1
Archer	11- Upland Hardwood Hammock	2	1
Ardilla	5 - Mixed Hardwood / Pine 7 - North Florida Flatwoods	2/1 1	1/1
Aripeka	12 - Wetland Hardwood Hammock 13 - Cabbage Palm Hammock	1	2
Arrendondo	4 - Turkey Oak / Longleaf Pine 5 - Mixed Hardwood / Pine 11- Upland Hardwood Hammock	2/1 2/1 2	1/1 2/1 2
Astatula	3 - Sand Pine Scrub 4 - Turkey Oak / Longleaf Pine	1 2/1	1 1/1
Astor	17 - Cypress Swamp 26 - Slough		
Bakersville	21 - Swamp Hardwoods	2	2
Barth	5 - Mixed Hardwood / Pine 7 - North Florida Flatwoods	2/1 1	2/1 2
Basinger	26 - Slough		
Basinger, depressional	17 - Cypress Swamp 21 - Swamp Hardwoods 25 - Freshwater Marsh and Ponds	2	2
Bayboro	17 - Cypress Swamp 21 - Swamp Hardwoods	2	2
Bayvi	18 - Salt Marsh		
Beaches	1 - North Florida Coastal Strand 2 - South Florida Coastal Strand	1 1	2 2
Benndale	5 - Mixed Hardwood / Pine	2/1	2/1
Bessie	19 - Mangrove Swamps		
Bethera	12 - Wetland Hardwood Hammock	2	2
Bibb	20 - Bottomland Hardwoods 21 - Swamp Hardwoods	2 2	2 2
Bigbee	11 - Upland Hardwood Hammock	2	2
Binnsville	5 - Mixed Hardwood / Pine	2/1	2/1
Bivans	11 - Upland Hardwood Hammock	2	2

SOIL SERIES	VEGETATIVE COMMUNITY	STORMWATER RULE VEGETATION GROUP	
		TP	TN
Bladen	7 – North Florida Flatwoods	1	2
	21 – Swamp Hardwoods	2	2
Blanton	5 – Mixed Hardwood / Pine	2/1	2/1
	11 – Upland Hardwood Hammock	2	2
Blichton	11 – Upland Hardwood Hammock	2	2
Bluff	21 – Swamp Hardwoods	2	2
Boardman	11 – Upland Hardwood Hammock	2	2
Boca	6 - South Florida Flatwoods	1	2
	8 – Cabbage Palm Flatwoods	1	2
Boca, depressional	25 – Freshwater Marsh and Ponds		
Boca, slough	26 – Slough		
Boca, tidal	18 – Salt Marsh		
Bohicket	18 – Salt Marsh		
Bonifay	4 – Turkey Oak / Longleaf Pine	2/1	1/1
Bonneau	11 – Upland Hardwood Hammock	3	1
Boswell	5 – Mixed Hardwood / Pine	2/1	1/1
Bowie	5 – Mixed Hardwood / Pine	2/1	1/1
Braden	6- South Florida Flatwoods	1	2
Bradenton	12 – Wetland Hardwood Hammock	2	2
	13 – Cabbage Palm Hammock	2	2
Brighton	25 – Freshwater Marsh and Ponds		
Broward	6 - South Florida Flatwoods	1	2
	8 – Cabbage Palm Flatwoods	1	2
Bulow	11 – Upland Hardwood Hammock	2	2
Bushnell	11 – Upland Hardwood Hammock	2	2
Cadillac	11 – Upland Hardwood Hammock	2	2
Canaveral	1 – North Florida Coastal Strand	1	2
	2 – South Florida Coastal Strand	1	2
Candler	4 – Turkey Oak / Longleaf Pine	2/1	1/1
Canova	25 – Freshwater Marsh and Ponds		
Captiva	26 – Slough		
Carnegie	5 – Mixed Hardwood / Pine	2/1	1/1
Cassia	3 – Sand Pine Scrub	1	1
	6 - South Florida Flatwoods	1	2
Centenary	4 – Turkey Oak / Longleaf Pine	2/1	1/1
Chaires	7 – North Florida Flatwoods	1	2
Charlotte	22 – Shrub Bog		
	26 – Slough		
Charlotte, ponded	25 – Freshwater Marsh and Ponds		
Chewaola	21 – Swamp Hardwoods	2	2
Chiefland	4 – Turkey Oak / Longleaf Pine	2/1	1/1
	11 – Upland Hardwood Hammock	2	2



Chipley	5 – Mixed Hardwood / Pine	2/1	1/1
SOIL SERIES	VEGETATIVE COMMUNITY	STORMWATER RULE VEGETATION GROUP	
		TP	TN
Chipola	5 – Mixed Hardwood / Pine	2/1	1/1
Chobee	17 – Cypress Swamp 21 – Swamp Hardwoods 25 – Freshwater Marsh and Ponds	2	2
Clarendon	5 – Mixed Hardwood / Pine	2/1	1/1
Coastal dunes	1 – North Florida Coastal Strand 2 – South Florida Coastal Strand	1 1	2 2
Cocoa	4 – Turkey Oak / Longleaf Pine	2/1	1/1
Compass	5 – Mixed Hardwood / Pine	2/1	1/1
Congaree	5 – Mixed Hardwood / Pine	2/1	1/1
Copeland	21 – Swamp Hardwoods 25 – Freshwater Marsh and Ponds	2	2
Cornelia	4 – Turkey Oak / Longleaf Pine	2/1	1/1
Corolla	1 – North Florida Coastal Strand	1	2
Cowarts	5 – Mixed Hardwood / Pine	2/1	1/1
Coxville	12 – Wetland Hardwood Hammock	2	2
Croatan	25 – Freshwater Marsh and Ponds		
Cuthbert	5 – Mixed Hardwood / Pine	2/1	1/1
Dade	9 – Everglades Flatwoods	1	2
Dania	25 – Freshwater Marsh and Ponds		
Daytona	3 – Sand Pine Scrub	1	1
Deland	4 – Turkey Oak / Longleaf Pine	2/1	1/1
Delks	6- South Florida Flatwoods	1	2
Delray	17 – Cypress Swamp 21 – Swamp Hardwoods 25 – Freshwater Marsh and Ponds 26 - Slough	2	2
Denaud	25 – Freshwater Marsh and Ponds		
Dirego	18 – Salt Marsh		
Dorovan	21 – Swamp Hardwoods 22 – Shrub Bog	2	2
Dothan	5 – Mixed Hardwood / Pine	2/1	1/1
Duckston	2 – South Florida Coastal Strand	1	2
Duette	3 – Sand Pine Scrub	1	1
Dunbar	5 – Mixed Hardwood / Pine	2/1	1/1
Duplin	18 – Salt Marsh		
Eaton	6 - South Florida Flatwoods	1	2
Eaton, depressional	17 – Cypress Swamp		
Eau Gallie	6 - South Florida Flatwoods 15 – Oak Hammocks	1 2	1 2
Eau Gallie, depressional	25 – Freshwater Marsh and Ponds		

Ebro	21 – Swamp Hardwoods	2	2
SOIL SERIES	VEGETATIVE COMMUNITY	STORMWATER RULE VEGETATION GROUP	
		TP	TN
Eglin	4 – Turkey Oak / Longleaf Pine	2/1	1/1
Electra	6 - South Florida Flatwoods	1	2
	7- North Florida Flatwoods	1	2
Ellzey	6 - South Florida Flatwoods	1	2
Elred	6 - South Florida Flatwoods	1	2
Emeralda	21 – Swamp Hardwoods	2	2
	25 – Freshwater Marsh and Ponds		
Escambia	7- North Florida Flatwoods	1	2
Estero	18 – Salt Marsh		
	19 – Mangrove Swamps		
Esto	5 – Mixed Hardwood / Pine	2/1	1/1
Eulonia	5 – Mixed Hardwood / Pine	2/1	1/1
Eureka	12 – Wetland Hardwood Hammock	2	2
Eureka, ponded	25 – Freshwater Marsh and Ponds		
Everglades	22 – Shrub Bog		
	25 – Freshwater Marsh and Ponds		
Faceville	5 – Mixed Hardwood / Pine	2/1	1/1
Farmton	6- South Florida Flatwoods	1	2
Felda	12 – Wetland Hardwood Hammock	2	2
	26 – Slough		
Felda, depressional	17 – Cypress Swamp		
	25 – Freshwater Marsh and Ponds		
Fellowship	11 – Upland Hardwood Hammock	2	2
Flemington	11 – Upland Hardwood Hammock	2	2
Florahome	11 – Upland Hardwood Hammock	2	2
Floralia	5 – Mixed Hardwood / Pine	2/1	1/1
	7 - North Florida Flatwoods	1	1
Floridana	17 – Cypress Swamp		
	21 – Swamp Hardwoods	2	2
	25 – Freshwater Marsh and Ponds		
Flavaquents	12 – Wetland Hardwood Hammock	2	2
Ft. Drum	8 – Cabbage Palm Flatwoods	1	2
Ft. Green	12 – Wetland Hardwood Hammock	2	2
	15 – Oak Hammock	2	2
Ft. Meade	11 – Upland Hardwood Hammock	2	2
Foxworth	4 – Turkey Oak / Longleaf Pine	2/1	1/1
	5 – Mixed Hardwood / Pine	2/1	1/1
Freshwater Marsh	25 – Freshwater Marsh and Ponds		
Freshwater Swamp	21 – Swamp Hardwoods	2	2
Fripp	1 – North Florida Coastal Strand	1	2
Fuquay	5 – Mixed Hardwood / Pine	2/1	1/1
Gainesville	4 – Turkey Oak / Longleaf Pine	2/1	1/1
	11 – Upland Hardwood Hammock	2	2

Galveston	1 – North Florida Coastal Strand	1	1
SOIL SERIES	VEGETATIVE COMMUNITY	STORMWATER RULE VEGETATION GROUP	
		TP	TN
Garcon	7- North Florida Flatwoods	1	2
Gator	21 – Swamp Hardwoods 25 – Freshwater Marsh and Ponds	2	2
Gentry	17 – Cypress Swamp 21 – Swamp Hardwoods 25 – Freshwater Marsh and Ponds	2	2
Gilead	5 – Mixed Hardwood / Pine	2/1	1/1
Goldsboro	5 – Mixed Hardwood / Pine 7- North Florida Flatwoods	2/1 1	1/1 2
Grady	17 – Cypress Swamp 21 – Swamp Hardwoods	2	2
Greenville	5 – Mixed Hardwood / Pine	2/1	1/1
Gritney	5 – Mixed Hardwood / Pine	2/1	1/1
Gunter	5 – Mixed Hardwood / Pine	2/1	1/1
Hague	5 – Mixed Hardwood / Pine 11 – Upland Hardwood Hammock	2/1 2	1/1 2
Hallendale	6 - South Florida Flatwoods 9 – Everglades Flatwoods	1 1	2 2
Hallendale, depressional	25 – Freshwater Marsh and Ponds		
Hallendale, slough	26 – Slough		
Hallendale, tidal	18 – Salt Marsh, 19 – Mangrove Swamps		
Hallendale, thermic variant	7- North Florida Flatwoods	1	2
Handsboro	18 – Salt Marsh		
Hannahatchee	5 – Mixed Hardwood . Pine	2/1	1/1
Heights	6 - South Florida Flatwoods	1	2
Hernanco	11 – Upland Hardwood Hammock	2	2
Herod	12 – Wetland Hardwood Hammock	2	2
Hobe	3 – Sand Pine Scrub	2	1
Hialeah	24 – Sawgrass Marsh		
Hilolo	13 – Cabbage Palm Hammock		
Holopaw	12 – Wetland Hardwood Hammock 26 – Slough	2	2
Holopaw, depressional	17 – Cypress Swamp 25 – Freshwater Marsh and Ponds		
Homosassa	18 – Salt Marsh		
Hontoon	21 – Swamp Hardwood 22 – Shrub Bog 25 – Freshwater Marsh and Ponds	2	2
Hornsville	5 – Mixed Hardwood / Pine	2/1	1/1
Huckabee	4 – Turkey Oak / Longleaf Pine	2/1	1/1
Hurricane	4 – Turkey Oak / Longleaf Pine	2/1	1/1

Hydraquents	19 – Mangrove Swamps		
SOIL SERIES	VEGETATIVE COMMUNITY	STORMWATER RULE VEGETATION GROUP	
		TP	TN
Iberia	21 – Swamp Hardwood 25 – Freshwater Marsh and Ponds	2	2
Ichetucknee	11 – Upland Hardwood Hammock	2	2
Immokalee	6 - South Florida Flatwoods	1	2
Immokalee, thermic variant	7 - North Florida Flatwoods	1	2
Immokalee, depressional	25 – Freshwater Marsh and Ponds		
Irvington	5 – Mixed Hardwood / Pine	2/1	1/1
Isles	26 – Slough		
Isles, depressional	17 – Cypress Swamp 25 – Freshwater Marsh and Ponds		
Isles, tidal	19 – Mangrove Swamps		
Istokpoga	22 – Shrub Bog 25 – Freshwater Marsh and Ponds		
Iuka	5 – Mixed Hardwood / Pine	2/1	1/1
Izagora	5 – Mixed Hardwood / Pine	2/1	1/1
Johns	5 – Mixed Hardwood / Pine	2/1	1/1
Johnston	21 – Swamp Hardwood	2	2
Jonathan	3 – Sand Pine Scrub	2	1
Jonesville	4 – Turkey Oak - Longleaf Pine 11 – Upland Hardwood Hammock	2/1 2	1/1 2
Jumper	11 – Upland Hardwood Hammock	2	2
Jupiter	12 – Wetland Hardwood Hammock	2	2
Kaliga	21 – Swamp Hardwood 25 – Freshwater Marsh and Ponds	2	2
Kaliga tidal	19 – Mangrove Swamps		
Kalmia	5 – Mixed Hardwood / Pin	2/1	1/1
Kanapaha	11 – Upland Hardwood Hammock 15 – Oak Hammock	2 2	2 2
Kenansville	5 – Mixed Hardwood / Pine	2/1	1/1
Kendrick	11 – Upland Hardwood Hammock	2	2
Kenny	4 – Turkey Oak / Longleaf Pine	2/1	1/1
Kershaw	4 – Turkey Oak / Longleaf Pine	2/1	1/1
Kesson	18 – Salt Marsh 19 – Mangrove Swamps		
Kinston	20 – Bottomland Hardwood	2	2
Klej	5 – Mixed Hardwood / Pine	2/1	1/1
Kureb	3 – Sand Pine Scrub	1	1
Lacoochee	18 – Salt Marsh		
Lake	4 – Turkey Oak / Longleaf Pine	2/1	1/1
Lakeland	4 – Turkey Oak / Longleaf Pine	2/1	1/1

Lakewood	3 – Sand Pine Scrub	2	1
SOIL SERIES	VEGETATIVE COMMUNITY	STORMWATER RULE VEGETATION GROUP	
		TP	TN
Lauderhill	21 – Swamp Hardwood 25 – Freshwater Marsh and Ponds	2	2
Lawnwood	6 - South Florida Flatwoods	1	2
Leaf	20 – Bottomland Hardwood	2	2
Ledwith	25 – Freshwater Marsh and Ponds		
Leefield	5 – Mixed Hardwood / Pine	2/1	1/1
	7 - North Florida Flatwoods	1	2
Leon	7- North Florida Flatwoods	1	2
Leon, ponded	25 – Freshwater Marsh and Ponds		
Lochloosa	11 – Upland Hardwood Hammock	2	2
	15 – Oak Hammocks	2	2
Lokosee	6 - South Florida Flatwoods	1	2
	12 – Wetland Hardwood Hammock	2	2
	26 – Slough		
Loxahatchee	24 – Sawgrass Marsh		
Lucy	5 – Mixed Hardwood / Pine	2/1	1/1
Lumbree	7 - North Florida Flatwoods	1	2
Lutterloh	7 - North Florida Flatwoods	1	2
Lynchburg	5 – Mixed Hardwood / Pine	2/1	1/1
	7 - North Florida Flatwoods	1	2
Lynne	6 - South Florida Flatwoods	1	2
Lynn Haven	7 - North Florida Flatwoods	1	2
Mabel	11 – Upland Hardwood Hammock	2	2
Magnolia	5 – Mixed Hardwood / Pine	2/1	1/1
Malabar	6 - South Florida Flatwoods	1	2
	26 - Slough		
Malabar, depressional	17 – Cypress Swamp		
	25 – Freshwater Marsh and Ponds		
Malbis	5 – Mixed Hardwood / Pine	2/1	1/1
Manatee	21 – Swamp Hardwood	2	2
	25 – Freshwater Marsh and Ponds		
Mandarin	3 – Sand Pine Scrub	1	1
	7 - North Florida Flatwoods	1	2
Mangrove swamp	19 – Mangrove Swamps		
Mantachee	20 – Bottomland Hardwood	2	2
Mantachee, overflow	21 – Swamp Hardwood	2	2
	22 – Shrub Bog		
Margate	16 – Scrub Cypress		
Marlboro	5 – Mixed Hardwood / Pine	2/1	1/1
Martel	17 – Cypress Swamp		
Masaryk	4 – Turkey Oak / Longleaf Pine	2/1	1/1
	11 – Upland Hardwood Hammock	2	2
Mascotte	7 - North Florida Flatwoods	1	2

SOIL SERIES	VEGETATIVE COMMUNITY	STORMWATER RULE VEGETATION GROUP	
		TP	TN
Matmon	8 – Cabbage Palm Flatwoods	1	2
	12 – Wetland Hardwood Hammock	2	2
Maurepas	17 – Cypress Swamp		
	25 – Freshwater Marsh and Ponds		
Maxton	5 – Mixed Hardwood and Pine	2/1	1/1
Meggett	7 - North Florida Flatwoods	1	2
	12 – Wetland Hardwood Hammock	2	2
Meggett, hyperthermic variant	6 - South Florida Flatwoods	1	2
	12 – Wetland Hardwood Hammock	2	2
Meggett, ponded	21 – Swamp Hardwood	2	2
Mckee	19 – Mangrove Swamps		
Micanopy	11 – Upland Hardwood Hammock	2	2
Micco	25 – Freshwater Marsh and Ponds		
Miccosukee	5 – Mixed Hardwood / Pine	2/1	1/1
Millhopper	11 – Upland Hardwood Hammock	2	2
Montverde	25 – Freshwater Marsh and Ponds		
Monteocha	17 – Cypress Swamp		
Moultrie	18 – Salt Marsh		
Mulat	7- North Florida Flatwoods	1	2
	23 – Pitcher Plant Bog		
Myakka	6 - South Florida Flatwoods	1	2
Myakka, depressional	25 – Freshwater Marsh and Ponds		
Myakka, tidal	18 – Salt Marsh		
Myatt	21 – Swamp Hardwoods	2	2
Narcoosee	6 - South Florida Flatwoods	1	2
	15 – Oak Hammock	2	2
Nittaw	17 – Cypress Swamp		
	21 – Swamp Hardwoods	2	2
	25 – Freshwater Marsh and Ponds		
Norfolk	5 – Mixed Hardwood / Pine	2/1	1/1
Nobleton	11 – Upland Hardwood Hammock	2	2
	15 – Oak Hammock	2	2
Nettles	6 - South Florida Flatwoods	1	2
Nettles, depressional	25 – Freshwater Marsh and Ponds		
Newhan	1 – North Florida Coastal Strand	1	2
Newnan	11 – Upland Hardwood Hammock	2	2
Nittaw	21 – Swamp Hardwoods	2	2
Nutall	12 – Wetland Hardwood Hammock	2	2
Ochopee	24 – Sawgrass Marsh		
Ocilla	5 – Mixed Hardwood / Pine	2/1	1/1
	7- North Florida Flatwoods	1	2
Ocilla, hyperthermic variant	6 - South Florida Flatwoods	1	2

Ocoee	25 – Freshwater Marsh and Ponds		
SOIL SERIES	VEGETATIVE COMMUNITY	STORMWATER RULE VEGETATION GROUP	
		TP	TN
Okeechobee	25 – Freshwater Marsh and Ponds		
Okeelanta	21 – Swamp Hardwoods 25 – Freshwater Marsh and Ponds	2	2
Okeelanta, tidal	19 – Mangrove Swamp		
Oklawaha	21 – Swamp Hardwoods 25 – Freshwater Marsh and Ponds	2	2
Oktibbeha	5 – Mixed Hardwood / Pine	2/1	1/1
Oldsmar	6 - South Florida Flatwoods 8 – Cabbage Palm Flatwoods	1 1	2 2
Oldsmar,depressional	25 – Freshwater Marsh and Ponds		
Oleno	12 – Wetland Hardwood Hammock	2	2
Olustee	7- North Florida Flatwoods	1	2
Ona	6 - South Florida Flatwoods 10 – Cutthroat Seeps	1	2
Ona, depressional	25 – Freshwater Marsh and Ponds		
Orangeburg	5 – Mixed Hardwood / Pine	2/1	1/1
Orlando	4 – Turkey Oak / Longleaf Pine	2/1	1/1
Orsino	3 – Sand Pine Scrub	1	1
Ortega	4 – Turkey Oak / Longleaf Pine 5 – Mixed Hardwood / Pine	2/1 2/1	1/1 1/1
Osier	7 - North Florida Flatwoods 21 – Swamp Hardwoods	1 2	2 2
Pactolus	5 – Mixed Hardwood / Pine	2/1	1/1
Pahokee	24 – Sawgrass Marsh		
Paisley	6 - South Florida Flatwoods	1	2
Palm Beach	2 – South Florida Coastal Strand	1	2
Palmetto	6 - South Florida Flatwoods	1	2
Palmetto,depressional	25 – Freshwater Marsh and Ponds		
Pamlico	21 – Swamp Hardwoods	2	2
Pansey	7- North Florida Flatwoods 21 – Swamp Hardwoods	1 2	2 2
Pantego	17 – Cypress Swamp 21 – Swamp Hardwoods	2	2
Pantego, ponded	25 – Freshwater Marsh and Ponds		
Paola	3 – Sand Pine Scrub	1	1
Parkwood	12 – Wetland Hardwood Hammock 13 – Cabbage Palm Hammock 15 – Oak Hammock	2 2	2 2
Peckish	19 – Mangrove Swamp		
Pedro	11 – Upland Hardwood Hammock	2	2
Pelham	7- North Florida Flatwoods	1	2

	21 – Swamp Hardwoods	2	2
SOIL SERIES	VEGETATIVE COMMUNITY	STORMWATER RULE VEGETATION GROUP	
		TP	TN
Pelham,hyperthermic variant	6 - South Florida Flatwoods	1	2
Pelham, ponded	21 – Swamp Hardwoods 25 – Freshwater Marsh and Ponds	2	2
Pellicer	18 – Salt Marsh		
Pendarvis	3 – Sand Pine Scrub	1	1
Pennekamp	14 – Tropical Hammocks		
Pennsuco	25 – Freshwater Marsh and Ponds		
Pennsuco, tidal	19 – Mangrove Swamp		
Pepper	6 - South Florida Flatwoods	1	2
Perrine	25 – Freshwater Marsh and Ponds		
Perrine, tidal	18 – Salt Marsh 19 – Mangrove Swamp		
Pickney	22 – Shrub Bog		
Pineda	6 - South Florida Flatwoods	1	2
Pineda, depressional	25 – Freshwater Marsh and Ponds		
Pineda, thermic variant	12 – Wetland Hardwood Hammock 26 - Slough	2	2
Pinellas	8 – Cabbage Palm Flatwoods	1	2
Placid	17 – Cypress Swamp 21 – Swamp Hardwoods 25 – Freshwater Marsh and Ponds 26 – Slough	2	2
Plantation	24 – Sawgrass Marsh		
Plummer	12 – Wetland Hardwood Hammock	2	2
Pocomoke	21 – Swamp Hardwoods	2	2
Pomello	3 – Sand Pine Scrub	1	1
Pomona	6 - South Florida Flatwoods	1	2
Pomona, thermic variant	7 - North Florida Flatwoods	1	2
Pomona,depressional	17 – Cypress Swamp 25 – Freshwater Marsh and Ponds		
Pompano	6 - South Florida Flatwoods 12 – Wetland Hardwood Hammock 26 – Slough	1 2	2 2
Pompano, flooded	17 – Cypress Swamp 21 – Swamp Hardwoods	2	2
Pompano,depressional	17 – Cypress Swamp 25 – Freshwater Marsh and Ponds		
Pompano, tidal	19 – Mangrove Swamp		
Ponzer	21 – Swamp Hardwoods	2	2
Pooler	20 – Bottomland Hardwoods	2	2
Popash	25 – Freshwater Marsh and Ponds		



SOIL SERIES	VEGETATIVE COMMUNITY	STORMWATER RULE VEGETATION GROUP	
		TP	TN
Pople	6 - South Florida Flatwoods 26 - Slough	1	2
Portsmouth	12 - Wetland Hardwood Hammock	2	2
Pottsburg	7 - North Florida Flatwoods	1	2
Punta	6 - South Florida Flatwoods	1	2
Rains	21 - Swamp Hardwoods 25 - Freshwater Marsh and Ponds	2	2
Red Bay	5 - Mixed Hardwood / Pine	2/1	1/1
Redlevel	6 - South Florida Flatwoods	1	2
Resota	3 - Sand Pine Scrub	1	1
Ridgeland	7 - North Florida Flatwoods	1	2
Ridgeland, ponded	17 - Cypress Swamp 25 - Freshwater Marsh and Ponds		
Riverview	20 - Bottomland Hardwoods	2	2
Riviera	8 - Cabbage Palm Flatwoods 12 - Wetland Hardwood Hammock 26 - Slough	1 2	2 2
Riviera, depressional	16 - Scrub Cypress 17 - Cypress Swamp 21 - Swamp Hardwoods 25 - Freshwater Marsh and Ponds	2	2
Robertsdale	5 - Mixed Hardwood / Pine	2/1	1/1
Rockdale	9 - Everglades Flatwoods	1	2
Rockland	24 - Sawgrass Marsh		
Ruston	5 - Mixed Hardwood / Pine	2/1	1/1
Rutledge	17 - Cypress Swamp 21 - Swamp Hardwoods 22 - Shrub Bog 23 - Pitcher Plant Bog	2	2
St. Johns	6 - South Florida Flatwoods 10 - Cutthroat Seeps	1	2
St. Johns, thermic variant	7 - North Florida Flatwoods	1	2
St. Johns, depressional	25 - Freshwater Marsh and Ponds		
St. Lucie	3 - Sand Pine Scrub	1	1
Salerno	6 - South Florida Flatwoods	1	2
Samsula	17 - Cypress Swamp 21 - Swamp Hardwoods 22 - Shrub Bog 25 - Freshwater Marsh and Ponds	2	2
Sanibel	25 - Freshwater Marsh and Ponds		
Sapelo	7 - North Florida Flatwoods	1	1
Satellite	2 - South Florida Coastal Strand	1	2

	3 – Sand Pine Scrub	1	1
SOIL SERIES	VEGETATIVE COMMUNITY	STORMWATER RULE VEGETATION GROUP	
		TP	TN
Savannah	5 – Mixed Hardwood / Pine	2/1	1/1
Sawyer	5 – Mixed Hardwood / Pine	2/1	1/1
Seffner	11 – Upland Hardwood Hammock	2	2
	15 – Oak Hammock	2	2
Scoggin	21 – Swamp Hardwoods	2	2
	25 – Freshwater Marsh and Ponds		
Scranton	7 - North Florida Flatwoods	1	1
Seewee	12 – Wetland Hardwood Hammock	2	2
Sellers	17 – Cypress Swamp		
	25 – Freshwater Marsh and Ponds		
Shenks	21 – Swamp Hardwoods	2	2
	25 – Freshwater Marsh and Ponds		
Shubuta	5 – Mixed Hardwood and Pine	2/1	1/1
Slickens	25 – Freshwater Marsh and Ponds		
Smyrna	6 - South Florida Flatwoods	1	2
Sparr	11 – Upland Hardwood Hammock	2	2
Stilson	5 – Mixed Hardwood / Pine	2/1	1/1
Stockade	21 – Swamp Hardwoods	2	2
Stough	5 – Mixed Hardwood / Pine	2/1	1/1
Submerged Marsh	25 – Freshwater Marsh and Ponds		
Sumterville	11 – Upland Hardwood Hammock	2	2
	15 – Oak Hammock	2	2
Sunsweet	5 – Mixed Hardwood / Pine	2/1	1/1
Surrency	17 – Cypress Swamp		
	21 – Swamp Hardwoods	2	2
Susanna	6 - South Florida Flatwoods	1	2
Susquehanna	5 – Mixed Hardwood / Pine	2/1	1/1
Swamp	21 – Swamp Hardwoods	2	2
Talquin	7 - North Florida Flatwoods	1	2
Tantile	6 - South Florida Flatwoods	1	2
Tarrytown	11 – Upland Hardwood Hammock	2	2
	15 – Oak Hammock	2	2
Tavares	4 – Turkey Oak / Longleaf Pine	2/1	1/1
	15 – Oak Hammock	2	2
Tequesta	25 – Freshwater Marsh and Ponds		
Terra Ceia	21 – Swamp Hardwoods	2	2
	25 – Freshwater Marsh and Ponds		
Terra Ceia, tidal	18 – Salt Marsh		
	19 – Mangrove Swamp		
Tifton	5 – Mixed Hardwood / Pine	2/1	1/1
Tisonia	18 – Salt Marsh		
Tocoi	6 - South Florida Flatwoods	1	2

Tomoka	21 – Swamp Hardwoods 25 – Freshwater Marsh and Ponds	2	2
SOIL SERIES	VEGETATIVE COMMUNITY	STORMWATER RULE VEGETATION GROUP	
		TP	TN
Tooles	12 – Wetland Hardwood Hammock	2	2
Torry	25 – Freshwater Marsh and Ponds		
Troup	4 – Turkey Oak / Longleaf Pine	2/1	1/1
Turnbull	18 – Salt Marsh		
Tuscawilla	12 – Wetland Hardwood Hammock	2	2
Typic fluvaquents	21 – Swamp Hardwoods	2	2
Valkaria	26 – Slough		
Valkaria,depressional	25 – Freshwater Marsh and Ponds		
Vaucluse	11 – Upland Hardwood Hammock	2	1
Vero	6 - South Florida Flatwoods	1	2
Vero, depressional	25 – Freshwater Marsh and Ponds		
Wabasso	6 - South Florida Flatwoods	1	2
	12 – Wetland Hardwood Hammock	2	2
	26 – Slough		
Wabasso,depressional	25 – Freshwater Marsh and Ponds		
Wabasso, thermic variant	7 - North Florida Flatwoods	1	1
Wacahoota	11 – Upland Hardwood Hammock	2	2
Wagram	5 – Mixed Hardwood / Pine	2/1	1/1
Wahee	20 – Bottomland Hardwoods	2	2
Wakulla	5 – Mixed Hardwood / Pine	2/1	1/1
Wauberg	25 – Freshwater Marsh and Ponds		
Wauchula	6 - South Florida Flatwoods	1	2
	26 – Slough		
Wauchula,depressional	25 – Freshwater Marsh and Ponds		
Waveland	6 - South Florida Flatwoods	1	2
Waveland,depressional	25 – Freshwater Marsh and Ponds		
Weekiwachee	18 – Salt Marsh		
Welaka	3 – Sand Pine Scrub	1	1
Wesconnett	21 – Swamp Hardwoods	2	2
Weston	12 – Wetland Hardwood Hammock	2	2
Wicksburg	5 – Mixed Hardwood / Pine	2/1	1/1
Williston	11 – Upland Hardwood Hammock	2	2
Winder	13 – Cabbage Palm Hammock		
	26 – Slough		
Winder, depressional	25 – Freshwater Marsh and Ponds		
Wulfert	19 – Mangrove Swamp		
Yemassee	5 – Mixed Hardwood / Pine	2/1	1/1
Younges	12 – Wetland Hardwood Hammock	2	2
Yulee	21 – Swamp Hardwoods	2	2
Zephyr	17 – Cypress Swamp		

	25 – Freshwater Marsh and Ponds		
SOIL SERIES	VEGETATIVE COMMUNITY	STORMWATER RULE VEGETATION GROUP	
		TP	TN
Zolfo	11 – Upland Hardwood Hammock 15 – Oak Hammock	2	2
Zuber	11 – Upland Hardwood Hammock	2	2

## **APPENDIX C**

### **DESCRIPTION OF LAND USE CATEGORIES AND RELATED EVENT MEAN CONCENTRATIONS**

Chapter 4 of the original 2007 report entitled “Evaluation of Current Stormwater Design Criteria within the State of Florida”, Final report submitted to Florida Department of Environmental Protection, Tallahassee, Fl. under Agreement S0108, is being updated with additional information. This Appendix will be added in the future.

**NOTE: THIS APPENDIX WILL NOT BE ADOPTED IN THE STORMWATER RULE**

**APPENDIX D: DRY RETENTION DEPTHS FOR 85% MASS REMOVAL**

**Calculated Dry Retention Depth  
For an Annual Mass Removal Efficiency of 85 Percent  
Panhandle (Zone 1)**

NDCIA CN	Percent DCIA																		
	10	15	20	25	30	35	40	45	50	55	60	65	70	75	80	85	90	95	100
30	0.34	0.45	0.54	0.66	0.76	0.88	0.99	1.10	1.22	1.33	1.44	1.56	1.67	1.78	1.90	2.01	2.13	2.24	2.35
35	0.40	0.48	0.58	0.69	0.79	0.90	1.01	1.12	1.23	1.35	1.46	1.57	1.68	1.79	1.91	2.02	2.13	2.24	2.35
40	0.48	0.54	0.63	0.73	0.83	0.94	1.04	1.15	1.26	1.37	1.48	1.59	1.70	1.80	1.91	2.02	2.13	2.24	2.35
45	0.62	0.63	0.70	0.79	0.89	0.98	1.08	1.18	1.29	1.39	1.50	1.61	1.71	1.82	1.93	2.03	2.14	2.25	2.35
50	0.80	0.76	0.80	0.86	0.95	1.04	1.13	1.23	1.33	1.43	1.53	1.63	1.74	1.84	1.94	2.04	2.15	2.25	2.35
55	1.00	0.92	0.93	0.97	1.04	1.11	1.20	1.29	1.38	1.47	1.57	1.66	1.76	1.86	1.96	2.06	2.16	2.26	2.35
60	1.21	1.11	1.09	1.11	1.15	1.22	1.29	1.36	1.44	1.53	1.62	1.71	1.80	1.89	1.98	2.07	2.17	2.26	2.35
65	1.42	1.32	1.28	1.28	1.30	1.34	1.39	1.46	1.53	1.60	1.68	1.76	1.84	1.92	2.01	2.09	2.18	2.27	2.35
70	1.63	1.52	1.47	1.45	1.46	1.49	1.53	1.57	1.63	1.69	1.76	1.82	1.89	1.97	2.04	2.12	2.20	2.28	2.35
75	1.82	1.72	1.67	1.64	1.64	1.65	1.67	1.71	1.75	1.79	1.84	1.90	1.96	2.02	2.08	2.15	2.22	2.28	2.35
80	2.01	1.92	1.87	1.84	1.83	1.83	1.84	1.85	1.88	1.91	1.95	1.99	2.04	2.08	2.13	2.19	2.24	2.30	2.35
85	2.17	2.11	2.07	2.04	2.02	2.01	2.01	2.02	2.03	2.05	2.07	2.09	2.12	2.16	2.19	2.23	2.27	2.31	2.35
90	2.32	2.27	2.24	2.22	2.20	2.19	2.18	2.18	2.18	2.19	2.20	2.21	2.22	2.24	2.26	2.28	2.30	2.33	2.35
95	2.40	2.39	2.37	2.36	2.34	2.34	2.33	2.32	2.32	2.32	2.32	2.32	2.32	2.32	2.33	2.33	2.34	2.35	2.35
98	2.39	2.38	2.38	2.38	2.37	2.37	2.37	2.36	2.36	2.36	2.36	2.36	2.36	2.35	2.35	2.35	2.35	2.35	2.35

**Calculated Dry Retention Depth  
For an Annual Mass Removal Efficiency of 85 Percent  
Central (Zone 2)**

NDCIA CN	Percent DCIA																		
	10	15	20	25	30	35	40	45	50	55	60	65	70	75	80	85	90	95	100
30	0.24	0.29	0.40	0.46	0.54	0.63	0.71	0.79	0.88	0.96	1.04	1.13	1.21	1.29	1.38	1.48	1.55	1.63	1.72
35	0.24	0.31	0.41	0.47	0.55	0.64	0.72	0.80	0.89	0.96	1.05	1.13	1.21	1.30	1.38	1.46	1.55	1.63	1.72
40	0.26	0.34	0.43	0.49	0.57	0.66	0.72	0.81	0.90	0.97	1.06	1.14	1.22	1.30	1.39	1.47	1.55	1.64	1.72
45	0.30	0.38	0.44	0.50	0.59	0.67	0.74	0.83	0.91	0.98	1.07	1.15	1.23	1.31	1.39	1.47	1.55	1.64	1.72
50	0.38	0.42	0.47	0.54	0.62	0.69	0.76	0.85	0.92	1.00	1.08	1.16	1.24	1.32	1.40	1.48	1.56	1.64	1.72
55	0.49	0.48	0.52	0.59	0.66	0.72	0.79	0.87	0.95	1.02	1.10	1.17	1.25	1.33	1.41	1.48	1.56	1.64	1.72
60	0.62	0.58	0.60	0.65	0.70	0.76	0.84	0.91	0.97	1.05	1.12	1.19	1.27	1.34	1.42	1.49	1.57	1.64	1.72
65	0.78	0.72	0.71	0.73	0.77	0.83	0.89	0.95	1.01	1.08	1.15	1.22	1.29	1.36	1.43	1.50	1.57	1.65	1.72
70	0.94	0.86	0.84	0.85	0.87	0.91	0.96	1.01	1.07	1.13	1.19	1.25	1.32	1.38	1.45	1.51	1.58	1.65	1.72
75	1.10	1.03	0.99	0.98	0.99	1.02	1.05	1.09	1.14	1.19	1.24	1.30	1.36	1.41	1.47	1.53	1.59	1.66	1.72
80	1.26	1.19	1.15	1.14	1.14	1.15	1.17	1.20	1.23	1.27	1.31	1.36	1.41	1.45	1.50	1.56	1.61	1.66	1.72
85	1.41	1.35	1.32	1.30	1.29	1.30	1.31	1.32	1.35	1.37	1.40	1.43	1.47	1.51	1.55	1.59	1.63	1.67	1.72
90	1.54	1.51	1.48	1.47	1.46	1.46	1.46	1.47	1.48	1.49	1.51	1.53	1.55	1.57	1.60	1.63	1.66	1.69	1.72
95	1.65	1.64	1.63	1.62	1.62	1.62	1.62	1.62	1.62	1.63	1.63	1.64	1.65	1.66	1.67	1.68	1.69	1.70	1.72
98	1.68	1.68	1.68	1.68	1.68	1.68	1.68	1.68	1.69	1.69	1.69	1.69	1.69	1.70	1.70	1.70	1.71	1.71	1.72



**Calculated Dry Retention Depth  
For an Annual Mass Removal Efficiency of 85 Percent  
Florida Keys (Zone 3)**

NDCIA CN	Percent DCIA																			
	10	15	20	25	30	35	40	45	50	55	60	65	70	75	80	85	90	95	100	
30	0.44	0.48	0.55	0.63	0.73	0.82	0.92	1.02	1.12	1.22	1.32	1.42	1.52	1.62	1.72	1.82	1.92	2.02	2.12	
35	0.63	0.57	0.60	0.69	0.78	0.86	0.96	1.05	1.14	1.24	1.34	1.43	1.53	1.63	1.73	1.83	1.93	2.03	2.12	
40	0.88	0.71	0.69	0.76	0.83	0.90	1.00	1.08	1.17	1.27	1.36	1.46	1.55	1.64	1.74	1.83	1.93	2.03	2.12	
45	1.13	0.87	0.82	0.84	0.89	0.97	1.05	1.12	1.21	1.30	1.39	1.48	1.57	1.66	1.75	1.84	1.94	2.03	2.12	
50	1.38	1.08	0.97	0.96	0.98	1.04	1.10	1.18	1.26	1.34	1.42	1.51	1.59	1.68	1.77	1.85	1.94	2.03	2.12	
55	1.62	1.29	1.15	1.10	1.10	1.13	1.18	1.25	1.31	1.38	1.46	1.54	1.62	1.70	1.79	1.87	1.95	2.04	2.12	
60	1.85	1.52	1.35	1.27	1.24	1.25	1.28	1.32	1.38	1.44	1.51	1.58	1.65	1.73	1.81	1.88	1.96	2.04	2.12	
65	2.05	1.73	1.55	1.45	1.40	1.39	1.40	1.42	1.47	1.52	1.57	1.63	1.70	1.77	1.83	1.90	1.98	2.05	2.12	
70	2.23	1.94	1.75	1.64	1.58	1.54	1.53	1.54	1.57	1.60	1.64	1.70	1.75	1.81	1.86	1.93	1.99	2.06	2.12	
75	2.39	2.13	1.95	1.83	1.76	1.71	1.69	1.68	1.69	1.71	1.74	1.77	1.81	1.85	1.90	1.96	2.01	2.06	2.12	
80	2.51	2.30	2.14	2.02	1.94	1.88	1.85	1.83	1.82	1.82	1.84	1.85	1.88	1.91	1.95	1.99	2.03	2.07	2.12	
85	2.59	2.43	2.29	2.19	2.11	2.05	2.01	1.98	1.96	1.95	1.95	1.96	1.97	1.99	2.01	2.03	2.06	2.09	2.12	
90	2.61	2.49	2.38	2.30	2.24	2.19	2.15	2.12	2.09	2.08	2.07	2.06	2.06	2.06	2.07	2.07	2.09	2.10	2.12	
95	2.47	2.42	2.38	2.33	2.30	2.27	2.24	2.22	2.19	2.18	2.16	2.15	2.14	2.13	2.12	2.12	2.12	2.12	2.12	
98	2.28	2.26	2.25	2.24	2.22	2.21	2.20	2.19	2.18	2.17	2.16	2.16	2.15	2.14	2.14	2.13	2.13	2.13	2.12	

**Calculated Dry Retention Depth  
For an Annual Mass Removal Efficiency of 85 Percent  
Coastal (Zone 4)**

NDCIA CN	Percent DCIA																			
	10	15	20	25	30	35	40	45	50	55	60	65	70	75	80	85	90	95	100	
30	0.25	0.36	0.45	0.51	0.62	0.71	0.79	0.90	0.98	1.08	1.17	1.26	1.36	1.45	1.54	1.64	1.73	1.82	1.91	
35	0.28	0.39	0.46	0.54	0.64	0.72	0.81	0.91	0.99	1.09	1.18	1.27	1.36	1.45	1.54	1.64	1.73	1.82	1.91	
40	0.35	0.43	0.48	0.57	0.66	0.74	0.83	0.92	1.01	1.10	1.19	1.28	1.37	1.46	1.55	1.64	1.73	1.82	1.91	
45	0.45	0.47	0.53	0.61	0.69	0.77	0.86	0.94	1.03	1.12	1.21	1.29	1.38	1.47	1.56	1.65	1.74	1.83	1.91	
50	0.58	0.55	0.59	0.66	0.73	0.81	0.89	0.97	1.05	1.14	1.22	1.31	1.40	1.48	1.57	1.66	1.74	1.83	1.91	
55	0.74	0.67	0.69	0.73	0.79	0.86	0.94	1.01	1.09	1.17	1.25	1.33	1.42	1.50	1.58	1.66	1.75	1.83	1.91	
60	0.92	0.82	0.80	0.82	0.87	0.93	0.99	1.06	1.13	1.21	1.28	1.36	1.44	1.51	1.59	1.67	1.75	1.83	1.91	
65	1.10	0.99	0.95	0.95	0.97	1.01	1.06	1.12	1.19	1.25	1.32	1.39	1.46	1.54	1.61	1.69	1.76	1.84	1.91	
70	1.28	1.16	1.10	1.09	1.09	1.12	1.16	1.20	1.25	1.31	1.37	1.44	1.50	1.57	1.64	1.70	1.77	1.84	1.91	
75	1.45	1.34	1.27	1.24	1.24	1.25	1.27	1.30	1.34	1.39	1.44	1.49	1.55	1.61	1.67	1.73	1.79	1.85	1.91	
80	1.60	1.50	1.44	1.41	1.39	1.39	1.41	1.43	1.45	1.48	1.52	1.56	1.61	1.65	1.70	1.75	1.81	1.86	1.91	
85	1.73	1.66	1.61	1.58	1.56	1.55	1.55	1.56	1.57	1.59	1.62	1.65	1.68	1.71	1.75	1.79	1.83	1.87	1.91	
90	1.84	1.79	1.76	1.73	1.72	1.71	1.70	1.70	1.71	1.72	1.73	1.74	1.76	1.78	1.81	1.83	1.86	1.89	1.91	
95	1.91	1.89	1.88	1.87	1.86	1.85	1.85	1.84	1.84	1.85	1.85	1.85	1.86	1.86	1.87	1.88	1.89	1.90	1.91	
98	1.91	1.91	1.90	1.90	1.90	1.90	1.90	1.90	1.90	1.90	1.90	1.90	1.90	1.90	1.90	1.91	1.91	1.91	1.91	

**Calculated Dry Retention Depth  
For an Annual Mass Removal Efficiency of 85 Percent  
Southeast Coast (Zone 5)**

NDCIA CN	Percent DCIA																		
	10	15	20	25	30	35	40	45	50	55	60	65	70	75	80	85	90	95	100
30	0.36	0.45	0.53	0.64	0.73	0.84	0.94	1.05	1.15	1.25	1.36	1.48	1.57	1.67	1.78	1.88	1.99	2.09	2.20
35	0.46	0.51	0.59	0.68	0.77	0.87	0.97	1.07	1.17	1.28	1.37	1.48	1.58	1.68	1.79	1.89	1.99	2.10	2.20
40	0.62	0.81	0.66	0.74	0.83	0.92	1.01	1.11	1.21	1.30	1.40	1.50	1.60	1.70	1.80	1.90	2.00	2.10	2.20
45	0.82	0.74	0.78	0.82	0.89	0.98	1.06	1.15	1.25	1.34	1.43	1.53	1.62	1.72	1.81	1.91	2.01	2.10	2.20
50	1.04	0.91	0.89	0.92	0.98	1.05	1.12	1.21	1.29	1.38	1.47	1.56	1.64	1.74	1.83	1.92	2.01	2.11	2.20
55	1.26	1.11	1.05	1.06	1.09	1.14	1.21	1.27	1.35	1.43	1.51	1.59	1.68	1.76	1.85	1.94	2.02	2.11	2.20
60	1.48	1.30	1.23	1.21	1.22	1.25	1.30	1.35	1.42	1.49	1.56	1.63	1.71	1.79	1.87	1.95	2.03	2.11	2.20
65	1.68	1.50	1.42	1.38	1.37	1.38	1.41	1.45	1.50	1.56	1.62	1.69	1.76	1.82	1.90	1.97	2.05	2.12	2.20
70	1.86	1.70	1.61	1.55	1.53	1.53	1.54	1.57	1.60	1.64	1.69	1.75	1.81	1.86	1.93	2.00	2.06	2.13	2.20
75	2.02	1.88	1.79	1.73	1.70	1.68	1.68	1.69	1.71	1.74	1.78	1.82	1.86	1.92	1.97	2.02	2.08	2.14	2.20
80	2.16	2.05	1.97	1.91	1.87	1.84	1.83	1.83	1.83	1.85	1.87	1.90	1.94	1.97	2.01	2.06	2.10	2.15	2.20
85	2.28	2.19	2.12	2.06	2.03	2.00	1.98	1.97	1.97	1.97	1.98	2.00	2.02	2.04	2.07	2.09	2.13	2.16	2.20
90	2.35	2.29	2.24	2.20	2.17	2.14	2.12	2.10	2.09	2.09	2.09	2.09	2.10	2.11	2.12	2.14	2.16	2.18	2.20
95	2.35	2.32	2.29	2.27	2.25	2.24	2.22	2.21	2.20	2.20	2.19	2.19	2.18	2.18	2.18	2.19	2.19	2.19	2.20
98	2.26	2.25	2.25	2.24	2.23	2.23	2.22	2.22	2.22	2.21	2.21	2.21	2.21	2.20	2.20	2.20	2.20	2.20	2.20



**APPENDIX E:**

**CALCULATED ANNUAL RUNOFF COEFFICIENTS  
FOR DESIGNATED METEOROLOGICAL ZONES  
AS A FUNCTION OF CURVE NUMBER AND DCIA**

Zone 1

Mean Annual Runoff Coefficients (C Values) as a Function of DCIA Percentage and Non-DCIA Curve Number (CN)

NDCIA CN	Percent DCIA																				
	0	5	10	15	20	25	30	35	40	45	50	55	60	65	70	75	80	85	90	95	100
30	0.006	0.048	0.090	0.132	0.175	0.217	0.259	0.301	0.343	0.386	0.428	0.470	0.512	0.554	0.596	0.639	0.681	0.723	0.765	0.807	0.849
35	0.009	0.051	0.093	0.135	0.177	0.219	0.261	0.303	0.345	0.387	0.429	0.471	0.513	0.555	0.597	0.639	0.681	0.723	0.765	0.807	0.849
40	0.014	0.056	0.098	0.139	0.181	0.223	0.265	0.307	0.348	0.390	0.432	0.474	0.515	0.557	0.599	0.641	0.682	0.724	0.766	0.808	0.849
45	0.020	0.062	0.103	0.145	0.186	0.228	0.269	0.311	0.352	0.394	0.435	0.476	0.518	0.559	0.601	0.642	0.684	0.725	0.767	0.808	0.849
50	0.029	0.070	0.111	0.152	0.193	0.234	0.275	0.316	0.357	0.398	0.439	0.480	0.521	0.562	0.603	0.644	0.685	0.726	0.767	0.808	0.849
55	0.039	0.079	0.120	0.161	0.201	0.242	0.282	0.323	0.363	0.404	0.444	0.485	0.525	0.566	0.606	0.647	0.687	0.728	0.768	0.809	0.849
60	0.052	0.092	0.132	0.172	0.212	0.252	0.291	0.331	0.371	0.411	0.451	0.491	0.531	0.570	0.610	0.650	0.690	0.730	0.770	0.810	0.849
65	0.069	0.108	0.147	0.186	0.225	0.264	0.303	0.342	0.381	0.420	0.459	0.498	0.537	0.576	0.615	0.654	0.693	0.732	0.771	0.810	0.849
70	0.092	0.130	0.167	0.205	0.243	0.281	0.319	0.357	0.395	0.433	0.471	0.508	0.546	0.584	0.622	0.660	0.698	0.736	0.774	0.812	0.849
75	0.121	0.158	0.194	0.230	0.267	0.303	0.340	0.376	0.412	0.449	0.485	0.522	0.558	0.595	0.631	0.667	0.704	0.740	0.777	0.813	0.849
80	0.162	0.196	0.230	0.265	0.299	0.334	0.368	0.402	0.437	0.471	0.506	0.540	0.574	0.609	0.643	0.678	0.712	0.746	0.781	0.815	0.849
85	0.220	0.252	0.283	0.315	0.346	0.378	0.409	0.441	0.472	0.503	0.535	0.566	0.598	0.629	0.661	0.692	0.724	0.755	0.787	0.818	0.849
90	0.312	0.339	0.366	0.393	0.419	0.446	0.473	0.500	0.527	0.554	0.581	0.608	0.634	0.661	0.688	0.715	0.742	0.769	0.796	0.823	0.849
95	0.478	0.496	0.515	0.533	0.552	0.571	0.589	0.608	0.626	0.645	0.664	0.682	0.701	0.719	0.738	0.757	0.775	0.794	0.812	0.831	0.849
98	0.656	0.666	0.676	0.685	0.695	0.705	0.714	0.724	0.734	0.743	0.753	0.763	0.772	0.782	0.792	0.801	0.811	0.821	0.830	0.840	0.849

Zone 2  
 Mean Annual Runoff Coefficients (C Values) as a Function  
 of DCIA Percentage and Non-DCIA Curve Number (CN)

NDCIA CN	Percent DCIA																				
	0	5	10	15	20	25	30	35	40	45	50	55	60	65	70	75	80	85	90	95	100
30	0.002	0.043	0.083	0.123	0.164	0.204	0.244	0.285	0.325	0.366	0.406	0.446	0.487	0.527	0.567	0.608	0.648	0.688	0.729	0.769	0.809
35	0.004	0.044	0.085	0.125	0.165	0.205	0.246	0.286	0.326	0.366	0.407	0.447	0.487	0.528	0.568	0.608	0.648	0.689	0.729	0.769	0.809
40	0.007	0.047	0.087	0.127	0.167	0.207	0.248	0.288	0.328	0.368	0.408	0.448	0.488	0.528	0.569	0.609	0.649	0.689	0.729	0.769	0.809
45	0.010	0.050	0.090	0.130	0.170	0.210	0.250	0.290	0.330	0.370	0.410	0.450	0.490	0.530	0.570	0.610	0.650	0.690	0.729	0.769	0.809
50	0.015	0.055	0.095	0.134	0.174	0.214	0.254	0.293	0.333	0.373	0.412	0.452	0.492	0.531	0.571	0.611	0.651	0.690	0.730	0.770	0.809
55	0.022	0.061	0.101	0.140	0.179	0.219	0.258	0.298	0.337	0.376	0.416	0.455	0.494	0.534	0.573	0.613	0.652	0.691	0.731	0.770	0.809
60	0.030	0.069	0.108	0.147	0.186	0.225	0.264	0.303	0.342	0.381	0.420	0.459	0.498	0.537	0.576	0.615	0.654	0.693	0.731	0.770	0.809
65	0.042	0.080	0.119	0.157	0.195	0.234	0.272	0.311	0.349	0.387	0.426	0.464	0.502	0.541	0.579	0.618	0.656	0.694	0.733	0.771	0.809
70	0.057	0.095	0.133	0.170	0.208	0.245	0.283	0.321	0.358	0.396	0.433	0.471	0.509	0.546	0.584	0.621	0.659	0.697	0.734	0.772	0.809
75	0.079	0.116	0.152	0.189	0.225	0.262	0.298	0.335	0.371	0.408	0.444	0.481	0.517	0.554	0.590	0.627	0.663	0.700	0.736	0.773	0.809
80	0.111	0.146	0.181	0.216	0.251	0.285	0.320	0.355	0.390	0.425	0.460	0.495	0.530	0.565	0.600	0.635	0.670	0.705	0.740	0.774	0.809
85	0.160	0.192	0.225	0.257	0.290	0.322	0.355	0.387	0.420	0.452	0.485	0.517	0.550	0.582	0.614	0.647	0.679	0.712	0.744	0.777	0.809
90	0.242	0.270	0.299	0.327	0.355	0.384	0.412	0.440	0.469	0.497	0.526	0.554	0.582	0.611	0.639	0.667	0.696	0.724	0.753	0.781	0.809
95	0.404	0.424	0.444	0.464	0.485	0.505	0.525	0.546	0.566	0.586	0.606	0.627	0.647	0.667	0.688	0.708	0.728	0.749	0.769	0.789	0.809
98	0.595	0.605	0.616	0.627	0.638	0.648	0.659	0.670	0.680	0.691	0.702	0.713	0.723	0.734	0.745	0.756	0.766	0.777	0.788	0.799	0.809



Zone 3

Mean Annual Runoff Coefficients (C Values) as a Function of DCIA Percentage and Non-DCIA Curve Number (CN)

NDCIA CN	Percent DCIA																				
	0	5	10	15	20	25	30	35	40	45	50	55	60	65	70	75	80	85	90	95	100
30	0.008	0.047	0.087	0.126	0.165	0.205	0.244	0.283	0.323	0.362	0.401	0.441	0.480	0.519	0.559	0.598	0.637	0.677	0.716	0.756	0.795
35	0.012	0.051	0.090	0.129	0.168	0.207	0.247	0.286	0.325	0.364	0.403	0.442	0.482	0.521	0.560	0.599	0.638	0.677	0.717	0.756	0.795
40	0.016	0.055	0.094	0.133	0.172	0.211	0.250	0.289	0.328	0.367	0.406	0.445	0.483	0.522	0.561	0.600	0.639	0.678	0.717	0.756	0.795
45	0.022	0.061	0.099	0.138	0.177	0.215	0.254	0.292	0.331	0.370	0.408	0.447	0.486	0.524	0.563	0.602	0.640	0.679	0.718	0.756	0.795
50	0.029	0.067	0.105	0.144	0.182	0.220	0.259	0.297	0.335	0.374	0.412	0.450	0.488	0.527	0.565	0.603	0.642	0.680	0.718	0.757	0.795
55	0.037	0.075	0.113	0.151	0.189	0.227	0.265	0.302	0.340	0.378	0.416	0.454	0.492	0.530	0.568	0.605	0.643	0.681	0.719	0.757	0.795
60	0.048	0.085	0.123	0.160	0.197	0.235	0.272	0.309	0.347	0.384	0.421	0.459	0.496	0.533	0.571	0.608	0.645	0.683	0.720	0.758	0.795
65	0.061	0.098	0.134	0.171	0.208	0.244	0.281	0.318	0.355	0.391	0.428	0.465	0.501	0.538	0.575	0.611	0.648	0.685	0.721	0.758	0.795
70	0.078	0.114	0.149	0.185	0.221	0.257	0.293	0.329	0.365	0.400	0.436	0.472	0.508	0.544	0.580	0.616	0.651	0.687	0.723	0.759	0.795
75	0.100	0.135	0.170	0.204	0.239	0.274	0.308	0.343	0.378	0.413	0.447	0.482	0.517	0.552	0.586	0.621	0.656	0.691	0.725	0.760	0.795
80	0.131	0.164	0.197	0.231	0.264	0.297	0.330	0.363	0.397	0.430	0.463	0.496	0.529	0.562	0.596	0.629	0.662	0.695	0.728	0.762	0.795
85	0.177	0.208	0.239	0.269	0.300	0.331	0.362	0.393	0.424	0.455	0.486	0.517	0.548	0.579	0.609	0.640	0.671	0.702	0.733	0.764	0.795
90	0.252	0.279	0.306	0.333	0.360	0.388	0.415	0.442	0.469	0.496	0.523	0.550	0.578	0.605	0.632	0.659	0.686	0.713	0.741	0.768	0.795
95	0.399	0.419	0.439	0.458	0.478	0.498	0.518	0.538	0.557	0.577	0.597	0.617	0.637	0.656	0.676	0.696	0.716	0.735	0.755	0.775	0.795
98	0.578	0.589	0.600	0.611	0.622	0.633	0.643	0.654	0.665	0.676	0.687	0.697	0.708	0.719	0.730	0.741	0.752	0.762	0.773	0.784	0.795

Zone 4

Mean Annual Runoff Coefficients (C Values) as a Function of DCIA Percentage and Non-DCIA Curve Number (CN)

NDCIA CN	Percent DCIA																				
	0	5	10	15	20	25	30	35	40	45	50	55	60	65	70	75	80	85	90	95	100
30	0.004	0.045	0.086	0.127	0.168	0.209	0.250	0.291	0.332	0.373	0.414	0.455	0.496	0.536	0.577	0.618	0.659	0.700	0.741	0.782	0.823
35	0.007	0.048	0.089	0.129	0.170	0.211	0.252	0.293	0.333	0.374	0.415	0.456	0.497	0.537	0.578	0.619	0.660	0.701	0.741	0.782	0.823
40	0.011	0.051	0.092	0.133	0.173	0.214	0.254	0.295	0.336	0.376	0.417	0.458	0.498	0.539	0.579	0.620	0.661	0.701	0.742	0.782	0.823
45	0.016	0.056	0.096	0.137	0.177	0.217	0.258	0.298	0.339	0.379	0.419	0.460	0.500	0.540	0.581	0.621	0.662	0.702	0.742	0.783	0.823
50	0.022	0.062	0.102	0.142	0.182	0.222	0.262	0.302	0.342	0.382	0.423	0.463	0.503	0.543	0.583	0.623	0.663	0.703	0.743	0.783	0.823
55	0.030	0.070	0.109	0.149	0.189	0.228	0.268	0.308	0.347	0.387	0.427	0.466	0.506	0.546	0.585	0.625	0.664	0.704	0.744	0.783	0.823
60	0.040	0.080	0.119	0.158	0.197	0.236	0.275	0.314	0.353	0.393	0.432	0.471	0.510	0.549	0.588	0.627	0.667	0.706	0.745	0.784	0.823
65	0.054	0.092	0.131	0.169	0.208	0.246	0.285	0.323	0.362	0.400	0.438	0.477	0.515	0.554	0.592	0.631	0.669	0.708	0.746	0.785	0.823
70	0.071	0.109	0.147	0.184	0.222	0.259	0.297	0.335	0.372	0.410	0.447	0.485	0.522	0.560	0.598	0.635	0.673	0.710	0.748	0.785	0.823
75	0.096	0.132	0.168	0.205	0.241	0.277	0.314	0.350	0.387	0.423	0.459	0.496	0.532	0.568	0.605	0.641	0.678	0.714	0.750	0.787	0.823
80	0.130	0.165	0.199	0.234	0.268	0.303	0.338	0.372	0.407	0.442	0.476	0.511	0.546	0.580	0.615	0.650	0.684	0.719	0.754	0.788	0.823
85	0.182	0.214	0.246	0.278	0.310	0.342	0.374	0.406	0.438	0.470	0.502	0.534	0.566	0.599	0.631	0.663	0.695	0.727	0.759	0.791	0.823
90	0.266	0.294	0.322	0.350	0.378	0.406	0.433	0.461	0.489	0.517	0.545	0.573	0.600	0.628	0.656	0.684	0.712	0.740	0.767	0.795	0.823
95	0.429	0.449	0.469	0.488	0.508	0.528	0.547	0.567	0.587	0.606	0.626	0.646	0.665	0.685	0.705	0.725	0.744	0.764	0.784	0.803	0.823
98	0.616	0.626	0.636	0.647	0.657	0.667	0.678	0.688	0.699	0.709	0.719	0.730	0.740	0.750	0.761	0.771	0.782	0.792	0.802	0.813	0.823



**Zone 5**  
**Mean Annual Runoff Coefficients (C Values) as a Function**  
**of DCIA Percentage and Non-DCIA Curve Number (CN)**

NDCIA CN	Percent DCIA																				
	0	5	10	15	20	25	30	35	40	45	50	55	60	65	70	75	80	85	90	95	100
30	0.008	0.048	0.088	0.128	0.168	0.208	0.248	0.288	0.328	0.368	0.408	0.448	0.488	0.528	0.568	0.608	0.648	0.688	0.728	0.768	0.808
35	0.012	0.052	0.092	0.132	0.171	0.211	0.251	0.291	0.331	0.370	0.410	0.450	0.490	0.529	0.569	0.609	0.649	0.689	0.728	0.768	0.808
40	0.018	0.057	0.097	0.136	0.176	0.215	0.255	0.294	0.334	0.373	0.413	0.452	0.492	0.531	0.571	0.611	0.650	0.690	0.729	0.769	0.808
45	0.025	0.064	0.103	0.142	0.182	0.221	0.260	0.299	0.338	0.377	0.417	0.456	0.495	0.534	0.573	0.612	0.651	0.691	0.730	0.769	0.808
50	0.034	0.072	0.111	0.150	0.189	0.227	0.266	0.305	0.343	0.382	0.421	0.460	0.498	0.537	0.576	0.614	0.653	0.692	0.731	0.769	0.808
55	0.044	0.082	0.121	0.159	0.197	0.235	0.273	0.312	0.350	0.388	0.426	0.464	0.502	0.541	0.579	0.617	0.655	0.693	0.732	0.770	0.808
60	0.057	0.095	0.132	0.170	0.207	0.245	0.282	0.320	0.357	0.395	0.433	0.470	0.508	0.545	0.583	0.620	0.658	0.695	0.733	0.770	0.808
65	0.073	0.110	0.147	0.183	0.220	0.257	0.294	0.330	0.367	0.404	0.441	0.477	0.514	0.551	0.588	0.624	0.661	0.698	0.735	0.771	0.808
70	0.093	0.129	0.165	0.201	0.236	0.272	0.308	0.344	0.379	0.415	0.451	0.486	0.522	0.558	0.594	0.629	0.665	0.701	0.737	0.772	0.808
75	0.120	0.155	0.189	0.223	0.258	0.292	0.327	0.361	0.395	0.430	0.464	0.498	0.533	0.567	0.602	0.636	0.670	0.705	0.739	0.774	0.808
80	0.157	0.189	0.222	0.254	0.287	0.319	0.352	0.385	0.417	0.450	0.482	0.515	0.547	0.580	0.613	0.645	0.678	0.710	0.743	0.775	0.808
85	0.209	0.239	0.269	0.299	0.329	0.359	0.389	0.419	0.449	0.479	0.509	0.538	0.568	0.598	0.628	0.658	0.688	0.718	0.748	0.778	0.808
90	0.292	0.318	0.343	0.369	0.395	0.421	0.447	0.472	0.498	0.524	0.550	0.576	0.602	0.627	0.653	0.679	0.705	0.731	0.756	0.782	0.808
95	0.445	0.464	0.482	0.500	0.518	0.536	0.554	0.572	0.590	0.609	0.627	0.645	0.663	0.681	0.699	0.717	0.736	0.754	0.772	0.790	0.808
98	0.614	0.624	0.633	0.643	0.653	0.662	0.672	0.682	0.692	0.701	0.711	0.721	0.730	0.740	0.750	0.760	0.769	0.779	0.789	0.798	0.808

**APPENDIX F:**

**DRY RETENTION SYSTEM**  
**MEAN ANNUAL NUTRIENT LOAD REDUCTION EFFICIENCY**  
**FOR VARIOUS RUNOFF DEPTHS AND METEROLOGICAL ZONES**  
**AS A FUNCTION OF**  
**DCIA AND NON-DCIA CURVE NUMBER**



**Mean Annual Mass Removal Efficiencies (%) for 0.10-inches of Retention for Zone 1**

NDCIA CN	Percent DCIA																	
	0-15	20	25	30	35	40	45	50	55	60	65	70	75	80	85	90	95	100
30	44.9	37.1	31.5	27.4	24.2	21.7	19.7	18.0	16.6	15.3	14.3	13.4	12.6	11.9	11.2	10.7	10.2	9.7
35	43.9	36.5	31.2	27.1	24.0	21.6	19.6	17.9	16.5	15.3	14.3	13.4	12.6	11.9	11.2	10.7	10.2	9.7
40	42.7	35.8	30.7	26.8	23.8	21.4	19.5	17.8	16.4	15.2	14.2	13.3	12.5	11.8	11.2	10.7	10.2	9.7
45	41.1	34.8	30.0	26.4	23.5	21.2	19.3	17.7	16.3	15.2	14.2	13.3	12.5	11.8	11.2	10.7	10.1	9.7
50	39.3	33.6	29.3	25.8	23.1	20.9	19.1	17.5	16.2	15.1	14.1	13.2	12.5	11.8	11.2	10.6	10.1	9.7
55	37.1	32.2	28.3	25.2	22.6	20.5	18.8	17.3	16.1	15.0	14.0	13.2	12.4	11.8	11.2	10.6	10.1	9.7
60	34.7	30.6	27.2	24.4	22.0	20.1	18.5	17.1	15.9	14.8	13.9	13.1	12.4	11.7	11.1	10.6	10.1	9.7
65	32.0	28.8	25.9	23.4	21.3	19.6	18.0	16.8	15.6	14.6	13.7	13.0	12.3	11.7	11.1	10.6	10.1	9.7
70	29.1	26.7	24.3	22.3	20.5	18.9	17.5	16.4	15.3	14.4	13.6	12.8	12.2	11.6	11.0	10.6	10.1	9.7
75	26.0	24.3	22.6	20.9	19.4	18.1	16.9	15.9	14.9	14.1	13.3	12.6	12.0	11.5	11.0	10.5	10.1	9.7
80	22.7	21.8	20.6	19.3	18.1	17.1	16.1	15.2	14.4	13.7	13.0	12.4	11.9	11.3	10.9	10.5	10.1	9.7
85	19.3	18.9	18.2	17.4	16.6	15.8	15.1	14.4	13.7	13.1	12.6	12.1	11.6	11.2	10.8	10.4	10.0	9.7
90	15.8	15.8	15.5	15.1	14.7	14.2	13.7	13.3	12.8	12.4	12.0	11.6	11.2	10.9	10.6	10.3	10.0	9.7
95	12.6	12.6	12.5	12.4	12.3	12.1	11.9	11.7	11.5	11.3	11.1	10.9	10.7	10.5	10.3	10.1	9.9	9.7
98	11.0	11.0	10.9	10.8	10.8	10.7	10.6	10.5	10.5	10.4	10.3	10.2	10.1	10.0	10.0	9.9	9.8	9.7

**Mean Annual Mass Removal Efficiencies (%) for 0.20-inches of Retention for Zone 1**

NDCIA CN	Percent DCIA																	
	0-15	20	25	30	35	40	45	50	55	60	65	70	75	80	85	90	95	100
30	66.8	58.3	51.5	46.0	41.5	37.7	34.6	32.0	29.7	27.7	26.0	24.5	23.1	21.9	20.8	19.8	18.9	18.1
35	65.3	57.4	50.9	45.5	41.1	37.5	34.4	31.9	29.6	27.6	25.9	24.4	23.1	21.9	20.8	19.8	18.9	18.1
40	63.4	56.2	50.0	45.0	40.7	37.2	34.2	31.7	29.5	27.5	25.9	24.4	23.0	21.9	20.8	19.8	18.9	18.1
45	61.1	54.7	49.0	44.2	40.2	36.8	33.9	31.4	29.3	27.4	25.8	24.3	23.0	21.8	20.8	19.8	18.9	18.1
50	58.4	52.9	47.7	43.3	39.5	36.3	33.5	31.2	29.1	27.2	25.6	24.2	22.9	21.8	20.7	19.8	18.9	18.1
55	55.3	50.7	46.2	42.2	38.7	35.7	33.1	30.8	28.8	27.0	25.5	24.1	22.8	21.7	20.7	19.7	18.9	18.1
60	51.7	48.2	44.4	40.8	37.7	34.9	32.5	30.3	28.4	26.8	25.3	23.9	22.7	21.6	20.6	19.7	18.9	18.1
65	47.9	45.4	42.3	39.3	36.5	34.0	31.8	29.8	28.0	26.4	25.0	23.7	22.6	21.5	20.5	19.7	18.9	18.1
70	43.8	42.2	39.8	37.4	35.0	32.8	30.9	29.1	27.4	26.0	24.7	23.5	22.4	21.4	20.5	19.6	18.8	18.1
75	39.4	38.6	37.0	35.2	33.3	31.5	29.8	28.2	26.8	25.4	24.2	23.1	22.1	21.2	20.3	19.5	18.8	18.1
80	34.8	34.7	33.8	32.6	31.2	29.7	28.4	27.1	25.9	24.7	23.7	22.7	21.8	20.9	20.2	19.4	18.8	18.1
85	30.5	30.5	30.2	29.5	28.6	27.6	26.6	25.6	24.7	23.8	22.9	22.1	21.3	20.6	19.9	19.3	18.7	18.1
90	26.1	26.1	26.1	25.8	25.4	24.9	24.3	23.7	23.1	22.5	21.8	21.2	20.7	20.1	19.6	19.1	18.6	18.1
95	21.9	21.9	21.9	21.8	21.7	21.5	21.3	21.1	20.8	20.5	20.2	19.9	19.6	19.3	19.0	18.7	18.4	18.1
98	19.8	19.8	19.7	19.7	19.6	19.5	19.4	19.3	19.2	19.1	19.0	18.9	18.8	18.6	18.5	18.4	18.3	18.1



**Mean Annual Mass Removal Efficiencies (%) for 0.30-inches of Retention for Zone 1**

NDCIA CN	Percent DCIA																	
	0-15	20	25	30	35	40	45	50	55	60	65	70	75	80	85	90	95	100
30	78.1	71.1	64.6	59.0	54.1	49.9	46.3	43.2	40.4	38.0	35.8	33.9	32.1	30.6	29.1	27.8	26.6	25.6
35	76.4	70.0	63.9	58.5	53.7	49.6	46.1	43.0	40.3	37.9	35.7	33.8	32.1	30.5	29.1	27.8	26.6	25.6
40	74.3	68.5	62.9	57.7	53.2	49.2	45.8	42.7	40.1	37.7	35.6	33.7	32.0	30.5	29.1	27.8	26.6	25.6
45	71.7	66.7	61.6	56.8	52.5	48.7	45.4	42.4	39.8	37.5	35.5	33.6	32.0	30.4	29.0	27.8	26.6	25.6
50	68.7	64.5	60.0	55.6	51.6	48.0	44.9	42.1	39.5	37.3	35.3	33.5	31.8	30.4	29.0	27.8	26.6	25.6
55	65.2	62.0	58.1	54.2	50.5	47.2	44.2	41.6	39.2	37.0	35.1	33.3	31.7	30.3	28.9	27.7	26.6	25.6
60	61.3	59.0	55.8	52.5	49.2	46.2	43.4	40.9	38.7	36.6	34.8	33.1	31.6	30.1	28.9	27.7	26.6	25.6
65	57.0	55.7	53.3	50.5	47.7	45.0	42.5	40.2	38.1	36.2	34.4	32.8	31.4	30.0	28.8	27.6	26.5	25.6
70	52.4	52.0	50.3	48.1	45.8	43.5	41.3	39.3	37.3	35.6	34.0	32.5	31.1	29.8	28.6	27.5	26.5	25.6
75	47.8	47.8	46.9	45.4	43.6	41.7	39.9	38.1	36.4	34.8	33.4	32.0	30.7	29.6	28.5	27.4	26.5	25.6
80	43.3	43.3	43.0	42.1	40.9	39.5	38.0	36.6	35.2	33.9	32.6	31.4	30.3	29.2	28.2	27.3	26.4	25.6
85	38.7	38.7	38.7	38.3	37.6	36.7	35.8	34.7	33.7	32.6	31.6	30.6	29.7	28.8	27.9	27.1	26.3	25.6
90	34.2	34.2	34.2	34.1	33.8	33.3	32.8	32.2	31.5	30.8	30.1	29.5	28.8	28.1	27.4	26.8	26.2	25.6
95	29.7	29.7	29.7	29.6	29.5	29.4	29.2	28.9	28.7	28.4	28.0	27.7	27.4	27.0	26.7	26.3	25.9	25.6
98	27.4	27.4	27.3	27.2	27.2	27.1	27.0	26.9	26.8	26.7	26.5	26.4	26.3	26.1	26.0	25.9	25.7	25.6

**Mean Annual Mass Removal Efficiencies (%) for 0.40-inches of Retention for Zone 1**

NDCIA CN	Percent DCIA																	
	0-15	20	25	30	35	40	45	50	55	60	65	70	75	80	85	90	95	100
30	84.4	79.0	73.5	68.3	63.6	59.3	55.6	52.2	49.2	46.5	44.1	41.9	39.9	38.1	36.4	34.9	33.5	32.2
35	82.6	77.7	72.6	67.6	63.1	59.0	55.3	52.0	49.0	46.4	44.0	41.8	39.8	38.0	36.4	34.9	33.5	32.2
40	80.5	76.2	71.4	66.8	62.5	58.5	54.9	51.7	48.8	46.2	43.8	41.7	39.7	38.0	36.3	34.9	33.5	32.2
45	77.9	74.3	70.0	65.7	61.6	57.9	54.4	51.3	48.5	46.0	43.7	41.6	39.6	37.9	36.3	34.8	33.5	32.2
50	74.8	71.9	68.3	64.4	60.6	57.1	53.8	50.8	48.1	45.7	43.4	41.4	39.5	37.8	36.2	34.8	33.4	32.2
55	71.3	69.2	66.2	62.8	59.4	56.1	53.1	50.2	47.7	45.3	43.2	41.2	39.4	37.7	36.2	34.7	33.4	32.2
60	67.4	66.1	63.7	60.9	57.9	54.9	52.1	49.5	47.1	44.9	42.8	40.9	39.2	37.6	36.1	34.7	33.4	32.2
65	63.1	62.6	60.9	58.6	56.1	53.5	51.0	48.6	46.4	44.3	42.4	40.6	38.9	37.4	35.9	34.6	33.4	32.2
70	58.6	58.6	57.7	56.0	53.9	51.8	49.6	47.5	45.5	43.6	41.8	40.1	38.6	37.1	35.8	34.5	33.3	32.2
75	54.3	54.3	54.0	52.9	51.4	49.7	47.9	46.1	44.4	42.7	41.1	39.6	38.2	36.8	35.6	34.4	33.3	32.2
80	49.8	49.8	49.8	49.3	48.3	47.2	45.8	44.4	43.0	41.5	40.2	38.9	37.6	36.4	35.3	34.2	33.2	32.2
85	45.4	45.4	45.4	45.2	44.7	44.0	43.1	42.1	41.1	40.0	39.0	37.9	36.9	35.9	34.9	34.0	33.1	32.2
90	40.8	40.8	40.8	40.8	40.6	40.3	39.8	39.2	38.6	37.9	37.2	36.5	35.8	35.0	34.3	33.6	32.9	32.2
95	36.3	36.3	36.3	36.3	36.2	36.1	35.9	35.7	35.4	35.1	34.8	34.5	34.1	33.8	33.4	33.0	32.6	32.2
98	34.0	34.0	33.9	33.9	33.8	33.7	33.6	33.5	33.4	33.3	33.2	33.1	32.9	32.8	32.7	32.5	32.4	32.2



Mean Annual Mass Removal Efficiencies (%) for 0.50-inches of Retention for Zone 1

NDCIA CN	Percent DCIA																	
	0-15	20	25	30	35	40	45	50	55	60	65	70	75	80	85	90	95	100
30	88.3	84.0	79.5	75.0	70.7	66.6	62.9	59.6	56.5	53.6	51.1	48.7	46.6	44.6	42.8	41.1	39.6	38.1
35	86.6	82.8	78.6	74.3	70.1	66.2	62.6	59.3	56.3	53.5	51.0	48.7	46.5	44.6	42.8	41.1	39.6	38.1
40	84.4	81.2	77.4	73.4	69.4	65.7	62.2	59.0	56.0	53.3	50.8	48.5	46.4	44.5	42.7	41.1	39.6	38.1
45	81.9	79.3	75.9	72.2	68.5	65.0	61.7	58.6	55.7	53.0	50.6	48.4	46.3	44.4	42.7	41.0	39.5	38.1
50	79.0	77.0	74.1	70.8	67.4	64.1	61.0	58.0	55.3	52.7	50.4	48.2	46.2	44.3	42.6	41.0	39.5	38.1
55	75.6	74.2	71.9	69.1	66.1	63.0	60.1	57.3	54.7	52.3	50.0	47.9	46.0	44.2	42.5	40.9	39.5	38.1
60	71.7	71.1	69.4	67.0	64.4	61.7	59.1	56.5	54.1	51.8	49.6	47.6	45.8	44.0	42.4	40.9	39.5	38.1
65	67.6	67.6	66.4	64.7	62.5	60.2	57.8	55.5	53.3	51.1	49.1	47.2	45.5	43.8	42.3	40.8	39.4	38.1
70	63.6	63.6	63.1	61.9	60.2	58.3	56.3	54.3	52.3	50.3	48.5	46.8	45.1	43.5	42.1	40.7	39.4	38.1
75	59.3	59.3	59.3	58.6	57.5	56.0	54.4	52.7	51.0	49.3	47.7	46.1	44.6	43.2	41.8	40.5	39.3	38.1
80	55.2	55.2	55.2	54.9	54.2	53.2	52.1	50.8	49.4	48.0	46.6	45.3	44.0	42.7	41.5	40.3	39.2	38.1
85	50.8	50.8	50.8	50.8	50.5	49.9	49.2	48.3	47.3	46.3	45.2	44.2	43.1	42.1	41.0	40.0	39.1	38.1
90	46.5	46.5	46.5	46.5	46.4	46.1	45.7	45.2	44.6	44.0	43.3	42.6	41.9	41.1	40.4	39.6	38.9	38.1
95	42.1	42.1	42.1	42.1	42.0	41.9	41.8	41.6	41.3	41.1	40.8	40.4	40.1	39.7	39.3	38.9	38.5	38.1
98	39.8	39.8	39.8	39.7	39.7	39.6	39.5	39.4	39.3	39.2	39.1	39.0	38.9	38.7	38.6	38.4	38.3	38.1

Mean Annual Mass Removal Efficiencies (%) for 0.60-inches of Retention for Zone 1

NDCIA CN	Percent DCIA																	
	0-15	20	25	30	35	40	45	50	55	60	65	70	75	80	85	90	95	100
30	90.9	87.5	83.7	79.9	76.0	72.3	68.8	65.5	62.5	59.7	57.1	54.7	52.4	50.4	48.5	46.7	45.0	43.5
35	89.2	86.3	82.8	79.1	75.4	71.9	68.5	65.3	62.3	59.5	56.9	54.6	52.4	50.3	48.4	46.6	45.0	43.5
40	87.2	84.7	81.6	78.2	74.7	71.3	68.0	64.9	62.0	59.3	56.8	54.4	52.3	50.2	48.4	46.6	45.0	43.5
45	84.8	82.8	80.1	77.0	73.8	70.6	67.4	64.4	61.6	59.0	56.6	54.3	52.1	50.1	48.3	46.6	45.0	43.5
50	82.0	80.6	78.3	75.6	72.6	69.6	66.7	63.9	61.2	58.7	56.3	54.0	52.0	50.0	48.2	46.5	44.9	43.5
55	78.8	77.9	76.1	73.8	71.2	68.5	65.8	63.1	60.6	58.2	55.9	53.8	51.8	49.9	48.1	46.5	44.9	43.5
60	75.1	74.9	73.6	71.7	69.5	67.1	64.7	62.2	59.9	57.6	55.5	53.4	51.5	49.7	48.0	46.4	44.9	43.5
65	71.4	71.4	70.7	69.3	67.5	65.5	63.3	61.1	59.0	56.9	54.9	53.0	51.2	49.4	47.8	46.3	44.8	43.5
70	67.6	67.6	67.3	66.4	65.1	63.5	61.7	59.8	57.9	56.0	54.2	52.4	50.7	49.1	47.6	46.2	44.8	43.5
75	63.6	63.6	63.6	63.2	62.3	61.1	59.7	58.1	56.6	54.9	53.3	51.7	50.2	48.7	47.3	46.0	44.7	43.5
80	59.6	59.6	59.6	59.5	59.0	58.2	57.2	56.1	54.8	53.5	52.2	50.8	49.5	48.2	47.0	45.8	44.6	43.5
85	55.5	55.5	55.5	55.5	55.3	54.9	54.2	53.5	52.6	51.7	50.6	49.6	48.6	47.5	46.5	45.4	44.4	43.5
90	51.3	51.3	51.3	51.3	51.3	51.1	50.8	50.4	49.8	49.3	48.6	47.9	47.2	46.5	45.7	45.0	44.2	43.5
95	47.1	47.1	47.1	47.1	47.1	47.0	46.9	46.7	46.5	46.3	46.0	45.7	45.4	45.0	44.7	44.3	43.9	43.5
98	45.0	45.0	44.9	44.9	44.9	44.8	44.7	44.7	44.6	44.5	44.4	44.3	44.2	44.0	43.9	43.8	43.6	43.5



**Mean Annual Mass Removal Efficiencies (%) for 0.70-inches of Retention for Zone 1**

NDCIA CN	Percent DCIA																	
	0-15	20	25	30	35	40	45	50	55	60	65	70	75	80	85	90	95	100
30	92.7	90.0	86.9	83.5	80.1	76.8	73.5	70.5	67.5	64.8	62.2	59.8	57.5	55.4	53.4	51.6	49.9	48.3
35	91.1	88.8	85.9	82.8	79.5	76.3	73.2	70.2	67.3	64.6	62.1	59.7	57.4	55.3	53.4	51.6	49.9	48.3
40	89.2	87.3	84.7	81.8	78.8	75.7	72.7	69.8	67.0	64.4	61.9	59.5	57.3	55.3	53.3	51.5	49.8	48.3
45	87.0	85.4	83.2	80.6	77.8	74.9	72.1	69.3	66.6	64.0	61.6	59.4	57.2	55.2	53.3	51.5	49.8	48.3
50	84.3	83.3	81.5	79.2	76.6	74.0	71.3	68.7	66.1	63.6	61.3	59.1	57.0	55.0	53.2	51.4	49.8	48.3
55	81.2	80.8	79.4	77.5	75.2	72.8	70.4	67.9	65.5	63.2	60.9	58.8	56.8	54.9	53.1	51.4	49.8	48.3
60	77.8	77.8	76.9	75.4	73.5	71.4	69.2	67.0	64.7	62.5	60.5	58.4	56.5	54.7	52.9	51.3	49.7	48.3
65	74.5	74.5	74.0	73.0	71.5	69.7	67.8	65.8	63.8	61.8	59.9	58.0	56.2	54.4	52.7	51.2	49.7	48.3
70	70.9	70.9	70.8	70.1	69.1	67.7	66.1	64.4	62.6	60.9	59.1	57.4	55.7	54.1	52.5	51.0	49.6	48.3
75	67.2	67.2	67.2	66.9	66.2	65.2	64.1	62.7	61.2	59.7	58.2	56.6	55.1	53.6	52.2	50.8	49.5	48.3
80	63.4	63.4	63.4	63.4	63.0	62.4	61.5	60.5	59.4	58.2	56.9	55.7	54.4	53.1	51.8	50.6	49.4	48.3
85	59.6	59.6	59.6	59.6	59.4	59.1	58.6	57.9	57.1	56.3	55.3	54.4	53.3	52.3	51.3	50.2	49.2	48.3
90	55.6	55.6	55.6	55.6	55.6	55.4	55.2	54.8	54.4	53.8	53.3	52.6	51.9	51.2	50.5	49.7	49.0	48.3
95	51.6	51.6	51.6	51.6	51.6	51.5	51.4	51.3	51.1	50.9	50.7	50.4	50.1	49.7	49.4	49.0	48.6	48.3
98	49.6	49.6	49.6	49.6	49.5	49.5	49.4	49.3	49.3	49.2	49.1	49.0	48.9	48.8	48.6	48.5	48.4	48.3

**Mean Annual Mass Removal Efficiencies (%) for 0.80-inches of Retention for Zone 1**

NDCIA CN	Percent DCIA																	
	0-15	20	25	30	35	40	45	50	55	60	65	70	75	80	85	90	95	100
30	94.0	91.9	89.2	86.3	83.3	80.3	77.4	74.5	71.7	69.1	66.6	64.2	62.0	59.9	57.9	56.0	54.2	52.5
35	92.6	90.7	88.3	85.6	82.7	79.9	77.0	74.2	71.5	68.9	66.4	64.1	61.9	59.8	57.8	56.0	54.2	52.5
40	90.8	89.2	87.1	84.6	82.0	79.2	76.5	73.8	71.2	68.6	66.2	63.9	61.8	59.7	57.8	55.9	54.2	52.5
45	88.6	87.5	85.7	83.4	81.0	78.5	75.8	73.3	70.8	68.3	66.0	63.7	61.6	59.6	57.7	55.9	54.2	52.5
50	86.1	85.4	84.0	82.0	79.8	77.5	75.0	72.6	70.2	67.9	65.6	63.5	61.4	59.5	57.6	55.8	54.1	52.5
55	83.2	83.0	81.9	80.3	78.4	76.3	74.1	71.8	69.6	67.4	65.2	63.2	61.2	59.3	57.5	55.7	54.1	52.5
60	80.2	80.2	79.5	78.3	76.7	74.9	72.9	70.9	68.8	66.7	64.7	62.8	60.9	59.1	57.3	55.7	54.1	52.5
65	77.1	77.1	76.8	75.9	74.7	73.2	71.5	69.7	67.8	66.0	64.1	62.3	60.5	58.8	57.1	55.5	54.0	52.5
70	73.7	73.7	73.7	73.2	72.3	71.1	69.8	68.3	66.7	65.0	63.3	61.6	60.0	58.4	56.9	55.4	53.9	52.5
75	70.3	70.3	70.3	70.1	69.5	68.7	67.7	66.5	65.2	63.8	62.3	60.9	59.4	58.0	56.6	55.2	53.8	52.5
80	66.7	66.7	66.7	66.7	66.4	65.9	65.2	64.3	63.3	62.2	61.0	59.8	58.6	57.4	56.1	54.9	53.7	52.5
85	63.1	63.1	63.1	63.1	63.0	62.7	62.3	61.7	61.0	60.2	59.4	58.5	57.5	56.6	55.6	54.6	53.5	52.5
90	59.3	59.3	59.3	59.3	59.3	59.2	59.0	58.7	58.3	57.9	57.3	56.8	56.1	55.5	54.8	54.0	53.3	52.5
95	55.5	55.5	55.5	55.5	55.5	55.5	55.5	55.4	55.2	55.0	54.8	54.6	54.3	54.0	53.7	53.3	52.9	52.5
98	53.7	53.7	53.7	53.7	53.7	53.7	53.6	53.6	53.5	53.4	53.3	53.2	53.1	53.0	52.9	52.8	52.7	52.5



Mean Annual Mass Removal Efficiencies (%) for 0.90-inches of Retention for Zone 1

NDCIA CN	Percent DCIA																	
	0-15	20	25	30	35	40	45	50	55	60	65	70	75	80	85	90	95	100
30	95.1	93.3	91.0	88.5	85.9	83.2	80.5	77.8	75.2	72.7	70.3	68.0	65.8	63.8	61.8	59.9	58.1	56.4
35	93.7	92.1	90.1	87.8	85.3	82.7	80.1	77.5	75.0	72.5	70.2	67.9	65.8	63.7	61.7	59.9	58.1	56.4
40	92.0	90.8	89.0	86.8	84.5	82.1	79.6	77.1	74.6	72.3	70.0	67.7	65.6	63.6	61.7	59.9	58.1	56.4
45	90.0	89.1	87.6	85.7	83.5	81.3	78.9	76.6	74.2	71.9	69.7	67.5	65.5	63.5	61.6	59.8	58.1	56.4
50	87.6	87.2	85.9	84.3	82.4	80.3	78.2	75.9	73.7	71.5	69.4	67.3	65.3	63.3	61.5	59.7	58.1	56.4
55	84.9	84.8	84.0	82.7	81.0	79.2	77.2	75.1	73.0	71.0	68.9	66.9	65.0	63.2	61.4	59.7	58.0	56.4
60	82.2	82.2	81.7	80.7	79.4	77.8	76.0	74.1	72.2	70.3	68.4	66.5	64.7	62.9	61.2	59.6	58.0	56.4
65	79.3	79.3	79.1	78.4	77.4	76.1	74.6	72.9	71.2	69.5	67.8	66.0	64.3	62.6	61.0	59.4	57.9	56.4
70	76.1	76.1	76.1	75.8	75.0	74.0	72.8	71.5	70.0	68.5	67.0	65.4	63.8	62.3	60.7	59.3	57.8	56.4
75	73.0	73.0	73.0	72.8	72.4	71.7	70.8	69.7	68.5	67.3	65.9	64.5	63.2	61.8	60.4	59.1	57.7	56.4
80	69.6	69.6	69.6	69.6	69.4	68.9	68.3	67.6	66.7	65.7	64.6	63.5	62.3	61.2	60.0	58.8	57.6	56.4
85	66.2	66.2	66.2	66.2	66.1	65.9	65.6	65.1	64.5	63.8	63.0	62.1	61.2	60.3	59.4	58.4	57.4	56.4
90	62.7	62.7	62.7	62.7	62.7	62.6	62.4	62.2	61.8	61.4	60.9	60.4	59.8	59.2	58.6	57.9	57.2	56.4
95	59.1	59.1	59.1	59.1	59.1	59.1	59.0	59.0	58.8	58.7	58.5	58.3	58.0	57.8	57.5	57.2	56.8	56.4
98	57.4	57.4	57.4	57.4	57.4	57.4	57.4	57.3	57.3	57.2	57.1	57.1	57.0	56.9	56.8	56.7	56.6	56.4

Mean Annual Mass Removal Efficiencies (%) for 1.00-inches of Retention for Zone 1

NDCIA CN	Percent DCIA																	
	0-15	20	25	30	35	40	45	50	55	60	65	70	75	80	85	90	95	100
30	95.9	94.4	92.5	90.3	87.9	85.5	83.1	80.6	78.2	75.8	73.6	71.4	69.2	67.2	65.3	63.4	61.6	60.0
35	94.6	93.3	91.6	89.5	87.3	85.0	82.7	80.3	77.9	75.6	73.4	71.2	69.1	67.1	65.2	63.4	61.6	60.0
40	93.0	92.0	90.5	88.6	86.6	84.4	82.1	79.9	77.6	75.4	73.2	71.1	69.0	67.0	65.2	63.3	61.6	60.0
45	91.0	90.5	89.2	87.5	85.6	83.6	81.5	79.3	77.2	75.0	72.9	70.9	68.8	66.9	65.1	63.3	61.6	60.0
50	88.8	88.6	87.6	86.2	84.5	82.7	80.7	78.7	76.6	74.6	72.6	70.6	68.6	66.8	65.0	63.2	61.6	60.0
55	86.4	86.3	85.7	84.6	83.2	81.5	79.8	77.9	75.9	74.0	72.1	70.2	68.4	66.6	64.8	63.1	61.5	60.0
60	83.9	83.9	83.5	82.7	81.5	80.1	78.6	76.9	75.1	73.4	71.6	69.8	68.0	66.3	64.7	63.0	61.5	60.0
65	81.2	81.2	81.0	80.5	79.6	78.5	77.2	75.7	74.1	72.5	70.9	69.3	67.6	66.0	64.4	62.9	61.4	60.0
70	78.3	78.3	78.3	78.0	77.4	76.5	75.5	74.2	72.9	71.5	70.1	68.6	67.1	65.6	64.2	62.7	61.3	60.0
75	75.3	75.3	75.3	75.2	74.8	74.2	73.4	72.5	71.4	70.3	69.1	67.8	66.5	65.1	63.8	62.5	61.2	60.0
80	72.1	72.1	72.1	72.1	72.0	71.6	71.1	70.4	69.6	68.7	67.8	66.7	65.6	64.5	63.4	62.2	61.1	60.0
85	68.9	68.9	68.9	68.9	68.9	68.7	68.4	68.0	67.5	66.8	66.1	65.4	64.5	63.7	62.8	61.8	60.9	60.0
90	65.6	65.6	65.6	65.6	65.6	65.6	65.5	65.2	65.0	64.6	64.2	63.7	63.1	62.6	61.9	61.3	60.6	60.0
95	62.3	62.3	62.3	62.3	62.3	62.3	62.3	62.2	62.1	62.0	61.8	61.6	61.4	61.2	60.9	60.6	60.3	60.0
98	60.8	60.8	60.8	60.8	60.8	60.8	60.7	60.7	60.7	60.6	60.6	60.5	60.4	60.3	60.3	60.2	60.1	60.0



**Mean Annual Mass Removal Efficiencies (%) for 1.25-inches of Retention for Zone 1**

NDCIA CN	Percent DCIA																	
	0-15	20	25	30	35	40	45	50	55	60	65	70	75	80	85	90	95	100
30	97.2	96.3	94.9	93.4	91.6	89.7	87.8	85.8	83.8	81.8	79.9	77.9	76.0	74.2	72.4	70.6	68.9	67.3
35	96.2	95.4	94.1	92.7	91.0	89.2	87.4	85.5	83.5	81.6	79.7	77.8	75.9	74.1	72.3	70.6	68.9	67.3
40	94.8	94.2	93.2	91.9	90.3	88.6	86.9	85.0	83.2	81.3	79.5	77.6	75.8	74.0	72.3	70.6	68.9	67.3
45	93.2	92.8	92.0	90.9	89.4	87.9	86.3	84.5	82.8	81.0	79.2	77.4	75.6	73.9	72.2	70.5	68.9	67.3
50	91.3	91.2	90.6	89.7	88.4	87.0	85.5	83.9	82.2	80.5	78.8	77.1	75.4	73.7	72.1	70.4	68.9	67.3
55	89.3	89.3	88.9	88.2	87.2	86.0	84.6	83.1	81.6	80.0	78.4	76.7	75.1	73.5	71.9	70.3	68.8	67.3
60	87.2	87.2	87.0	86.5	85.7	84.7	83.5	82.2	80.8	79.3	77.8	76.3	74.8	73.2	71.7	70.2	68.8	67.3
65	84.9	84.9	84.9	84.5	83.9	83.1	82.1	81.0	79.8	78.5	77.1	75.7	74.3	72.9	71.5	70.1	68.7	67.3
70	82.5	82.5	82.5	82.4	81.9	81.3	80.6	79.7	78.6	77.5	76.3	75.1	73.8	72.5	71.2	69.9	68.6	67.3
75	80.0	80.0	80.0	79.9	79.7	79.3	78.7	78.0	77.2	76.3	75.3	74.2	73.1	72.0	70.9	69.7	68.5	67.3
80	77.3	77.3	77.3	77.3	77.3	77.0	76.6	76.1	75.5	74.8	74.0	73.2	72.3	71.4	70.4	69.4	68.4	67.3
85	74.6	74.6	74.6	74.6	74.6	74.5	74.3	73.9	73.5	73.1	72.5	71.9	71.2	70.5	69.8	69.0	68.2	67.3
90	71.7	71.7	71.7	71.7	71.7	71.7	71.7	71.5	71.3	71.1	70.7	70.4	70.0	69.5	69.0	68.5	67.9	67.3
95	69.0	69.0	69.0	69.0	69.0	69.0	69.0	69.0	68.9	68.9	68.7	68.6	68.5	68.3	68.1	67.8	67.6	67.3
98	67.8	67.8	67.8	67.8	67.8	67.8	67.8	67.8	67.8	67.8	67.7	67.6	67.6	67.5	67.5	67.4	67.3	67.3

**Mean Annual Mass Removal Efficiencies (%) for 1.50-inches of Retention for Zone 1**

NDCIA CN	Percent DCIA																	
	0-15	20	25	30	35	40	45	50	55	60	65	70	75	80	85	90	95	100
30	98.0	97.5	96.5	95.3	94.0	92.5	90.9	89.3	87.7	86.0	84.3	82.7	81.0	79.3	77.7	76.1	74.6	73.1
35	97.1	96.7	95.8	94.7	93.5	92.1	90.6	89.0	87.4	85.8	84.1	82.5	80.9	79.3	77.7	76.1	74.6	73.1
40	96.0	95.7	95.0	94.0	92.8	91.5	90.1	88.6	87.1	85.5	83.9	82.3	80.7	79.2	77.6	76.1	74.6	73.1
45	94.7	94.5	93.9	93.1	92.0	90.8	89.5	88.1	86.6	85.1	83.6	82.1	80.6	79.0	77.5	76.0	74.5	73.1
50	93.1	93.1	92.7	92.0	91.1	90.0	88.8	87.5	86.1	84.7	83.3	81.8	80.3	78.9	77.4	75.9	74.5	73.1
55	91.4	91.4	91.2	90.7	89.9	89.0	87.9	86.8	85.5	84.2	82.8	81.5	80.1	78.6	77.2	75.8	74.4	73.1
60	89.6	89.6	89.6	89.2	88.6	87.8	86.9	85.9	84.7	83.5	82.3	81.0	79.7	78.4	77.0	75.7	74.4	73.1
65	87.7	87.7	87.7	87.5	87.0	86.4	85.7	84.8	83.8	82.8	81.7	80.5	79.3	78.1	76.8	75.6	74.3	73.1
70	85.7	85.7	85.7	85.6	85.3	84.8	84.2	83.5	82.7	81.8	80.9	79.9	78.8	77.7	76.5	75.4	74.2	73.1
75	83.5	83.5	83.5	83.5	83.3	83.0	82.6	82.1	81.4	80.7	79.9	79.1	78.1	77.2	76.2	75.2	74.1	73.1
80	81.2	81.2	81.2	81.2	81.2	81.0	80.8	80.4	79.9	79.4	78.8	78.1	77.3	76.5	75.7	74.9	74.0	73.1
85	78.9	78.9	78.9	78.9	78.9	78.9	78.7	78.5	78.2	77.8	77.4	76.9	76.3	75.8	75.1	74.5	73.8	73.1
90	76.5	76.5	76.5	76.5	76.5	76.5	76.5	76.4	76.3	76.1	75.8	75.5	75.2	74.8	74.4	74.0	73.6	73.1
95	74.2	74.2	74.2	74.2	74.2	74.2	74.2	74.2	74.2	74.2	74.2	74.1	74.0	73.9	73.8	73.6	73.5	73.1
98	73.3	73.3	73.3	73.3	73.3	73.3	73.3	73.3	73.3	73.3	73.3	73.3	73.3	73.2	73.2	73.2	73.1	73.1



Mean Annual Mass Removal Efficiencies (%) for 1.75-inches of Retention for Zone 1

NDCIA CN	Percent DCIA																	
	0-15	20	25	30	35	40	45	50	55	60	65	70	75	80	85	90	95	100
30	98.4	98.2	97.6	96.6	95.6	94.4	93.2	91.8	90.4	89.0	87.6	86.1	84.7	83.3	81.8	80.4	79.0	77.6
35	97.7	97.6	97.0	96.1	95.1	94.0	92.8	91.5	90.2	88.8	87.4	86.0	84.6	83.2	81.8	80.4	79.0	77.6
40	96.8	96.7	96.2	95.5	94.5	93.5	92.4	91.1	89.9	88.5	87.2	85.8	84.4	83.1	81.7	80.3	78.9	77.6
45	95.8	95.7	95.3	94.6	93.8	92.9	91.8	90.6	89.5	88.2	86.9	85.6	84.2	82.9	81.6	80.2	78.9	77.6
50	94.5	94.5	94.2	93.7	93.0	92.1	91.2	90.1	89.0	87.8	86.6	85.3	84.0	82.8	81.5	80.2	78.9	77.6
55	93.1	93.1	92.9	92.5	92.0	91.2	90.4	89.4	88.4	87.3	86.1	85.0	83.8	82.6	81.3	80.1	78.8	77.6
60	91.5	91.5	91.5	91.2	90.8	90.1	89.4	88.6	87.7	86.7	85.6	84.5	83.4	82.3	81.1	80.0	78.8	77.6
65	89.9	89.9	89.9	89.7	89.4	88.9	88.3	87.6	86.8	86.0	85.0	84.0	83.0	82.0	80.9	79.8	78.7	77.6
70	88.1	88.1	88.1	88.1	87.9	87.5	87.0	86.4	85.8	85.1	84.3	83.4	82.5	81.6	80.6	79.6	78.6	77.6
75	86.3	86.3	86.3	86.3	86.2	85.9	85.6	85.1	84.6	84.0	83.4	82.7	81.9	81.1	80.3	79.4	78.5	77.6
80	84.3	84.3	84.3	84.3	84.3	84.2	84.0	83.7	83.3	82.8	82.4	81.8	81.2	80.6	79.9	79.1	78.4	77.6
85	82.3	82.3	82.3	82.3	82.3	82.3	82.2	82.0	81.8	81.5	81.2	80.8	80.4	79.9	79.3	78.8	78.2	77.6
90	80.3	80.3	80.3	80.3	80.3	80.3	80.3	80.2	80.1	80.0	79.8	79.6	79.3	79.0	78.7	78.4	78.0	77.6
95	78.4	78.4	78.4	78.4	78.4	78.4	78.4	78.4	78.4	78.4	78.4	78.3	78.2	78.1	78.0	77.9	77.7	77.6
98	77.7	77.7	77.7	77.7	77.7	77.7	77.7	77.7	77.7	77.7	77.7	77.7	77.7	77.7	77.7	77.6	77.6	77.6

Mean Annual Mass Removal Efficiencies (%) for 2.00-inches of Retention for Zone 1

NDCIA CN	Percent DCIA																	
	0-15	20	25	30	35	40	45	50	55	60	65	70	75	80	85	90	95	100
30	98.6	98.6	98.3	97.6	96.7	95.8	94.8	93.7	92.5	91.3	90.0	88.8	87.5	86.2	85.0	83.7	82.4	81.2
35	98.1	98.1	97.8	97.1	96.3	95.4	94.4	93.4	92.2	91.1	89.9	88.7	87.4	86.2	84.9	83.7	82.4	81.2
40	97.5	97.4	97.1	96.6	95.8	94.9	94.0	93.0	91.9	90.8	89.7	88.5	87.3	86.0	84.8	83.6	82.4	81.2
45	96.6	96.6	96.3	95.8	95.2	94.4	93.5	92.6	91.6	90.5	89.4	88.3	87.1	85.9	84.7	83.6	82.4	81.2
50	95.6	95.6	95.4	94.9	94.4	93.7	93.0	92.1	91.1	90.1	89.1	88.0	86.9	85.8	84.6	83.5	82.3	81.2
55	94.4	94.4	94.2	93.9	93.5	92.9	92.2	91.4	90.6	89.6	88.7	87.7	86.6	85.6	84.5	83.4	82.3	81.2
60	93.0	93.0	93.0	92.8	92.4	91.9	91.3	90.6	89.9	89.1	88.2	87.3	86.3	85.3	84.3	83.3	82.2	81.2
65	91.6	91.6	91.6	91.5	91.2	90.8	90.3	89.8	89.1	88.4	87.6	86.8	85.9	85.0	84.1	83.1	82.2	81.2
70	90.1	90.1	90.1	90.1	89.9	89.6	89.2	88.7	88.2	87.6	86.9	86.2	85.4	84.6	83.8	83.0	82.1	81.2
75	88.5	88.5	88.5	88.5	88.4	88.2	87.9	87.6	87.1	86.7	86.1	85.5	84.9	84.2	83.5	82.8	82.0	81.2
80	86.8	86.8	86.8	86.8	86.8	86.7	86.5	86.3	86.0	85.6	85.2	84.7	84.2	83.7	83.1	82.5	81.9	81.2
85	85.0	85.0	85.0	85.0	85.0	84.9	84.8	84.6	84.4	84.1	83.8	83.4	83.1	82.6	82.2	81.7	81.2	81.2
90	83.3	83.3	83.3	83.3	83.3	83.3	83.3	83.3	83.2	83.1	82.9	82.8	82.6	82.3	82.1	81.8	81.5	81.2
95	81.7	81.7	81.7	81.7	81.7	81.7	81.7	81.7	81.7	81.7	81.7	81.7	81.6	81.6	81.5	81.4	81.3	81.2
98	81.2	81.2	81.2	81.2	81.2	81.2	81.2	81.2	81.2	81.2	81.2	81.2	81.2	81.2	81.2	81.2	81.2	81.2



Mean Annual Mass Removal Efficiencies (%) for 2.25-inches of Retention for Zone 1

NDCIA	Percent DCIA																		
	CN	0-15	20	25	30	35	40	45	50	55	60	65	70	75	80	85	90	95	100
30	98.9	98.9	98.7	98.2	97.6	96.8	95.9	95.0	94.0	93.0	91.9	90.8	89.7	88.6	87.5	86.3	85.2	84.1	
35	98.5	98.5	98.3	97.9	97.2	96.5	95.6	94.7	93.8	92.8	91.8	90.7	89.6	88.5	87.4	86.3	85.2	84.1	
40	97.9	97.9	97.8	97.3	96.8	96.1	95.3	94.4	93.5	92.6	91.6	90.5	89.5	88.4	87.3	86.2	85.1	84.1	
45	97.3	97.3	97.1	96.7	96.2	95.5	94.8	94.0	93.2	92.3	91.3	90.3	89.3	88.3	87.2	86.2	85.1	84.1	
50	96.5	96.5	96.3	95.9	95.5	94.9	94.3	93.6	92.8	91.9	91.0	90.1	89.1	88.1	87.1	86.1	85.1	84.1	
55	95.4	95.4	95.3	95.0	94.6	94.2	93.6	93.0	92.3	91.5	90.6	89.8	88.9	87.9	87.0	86.0	85.0	84.1	
60	94.3	94.3	94.2	94.0	93.7	93.3	92.8	92.3	91.6	90.9	90.2	89.4	88.6	87.7	86.8	85.9	85.0	84.1	
65	93.0	93.0	93.0	92.9	92.7	92.4	92.0	91.5	90.9	90.3	89.7	89.0	88.2	87.4	86.6	85.8	84.9	84.1	
70	91.6	91.6	91.6	91.6	91.5	91.3	91.0	90.5	90.1	89.6	89.0	88.4	87.8	87.1	86.4	85.6	84.8	84.1	
75	90.3	90.3	90.3	90.3	90.2	90.1	89.8	89.5	89.2	88.8	88.3	87.8	87.3	86.7	86.1	85.4	84.7	84.1	
80	88.8	88.8	88.8	88.8	88.8	88.7	88.6	88.4	88.1	87.8	87.5	87.1	86.7	86.2	85.7	85.2	84.6	84.1	
85	87.3	87.3	87.3	87.3	87.3	87.3	87.2	87.1	86.9	86.8	86.5	86.3	86.0	85.6	85.3	84.9	84.5	84.1	
90	85.7	85.7	85.7	85.7	85.7	85.7	85.7	85.7	85.7	85.6	85.5	85.4	85.2	85.0	84.8	84.6	84.3	84.1	
95	84.4	84.4	84.4	84.4	84.4	84.4	84.4	84.4	84.4	84.4	84.4	84.4	84.4	84.3	84.3	84.2	84.1	84.1	
98	84.1	84.1	84.1	84.1	84.1	84.1	84.1	84.1	84.1	84.1	84.1	84.1	84.1	84.1	84.1	84.1	84.1	84.1	84.1

Mean Annual Mass Removal Efficiencies (%) for 2.50-inches of Retention for Zone 1

NDCIA	Percent DCIA																		
	CN	0-15	20	25	30	35	40	45	50	55	60	65	70	75	80	85	90	95	100
30	99.1	99.1	99.0	98.7	98.2	97.6	96.8	96.1	95.2	94.3	93.4	92.5	91.5	90.5	89.5	88.5	87.4	86.4	
35	98.7	98.7	98.6	98.4	97.9	97.3	96.6	95.8	95.0	94.2	93.3	92.3	91.4	90.4	89.4	88.4	87.4	86.4	
40	98.3	98.3	98.2	98.0	97.5	96.9	96.3	95.5	94.8	93.9	93.1	92.2	91.3	90.3	89.3	88.4	87.4	86.4	
45	97.8	97.8	97.7	97.4	97.0	96.4	95.8	95.2	94.4	93.7	92.8	92.0	91.1	90.2	89.3	88.3	87.4	86.4	
50	97.1	97.1	97.0	96.7	96.3	95.9	95.3	94.7	94.1	93.3	92.6	91.7	90.9	90.0	89.2	88.2	87.3	86.4	
55	96.3	96.3	96.2	95.9	95.6	95.2	94.7	94.2	93.6	92.9	92.2	91.5	90.7	89.9	89.0	88.2	87.3	86.4	
60	95.3	95.3	95.2	95.0	94.8	94.4	94.0	93.6	93.0	92.4	91.8	91.1	90.4	89.6	88.9	88.1	87.2	86.4	
65	94.1	94.1	94.1	94.0	93.8	93.6	93.2	92.9	92.4	91.9	91.3	90.7	90.0	89.4	88.7	87.9	87.2	86.4	
70	92.9	92.9	92.9	92.9	92.8	92.6	92.4	92.0	91.6	91.2	90.7	90.2	89.6	89.1	88.4	87.8	87.1	86.4	
75	91.7	91.7	91.7	91.7	91.7	91.6	91.4	91.1	90.8	90.4	90.1	89.6	89.2	88.7	88.1	87.6	87.0	86.4	
80	90.4	90.4	90.4	90.4	90.4	90.4	90.3	90.1	89.9	89.6	89.3	89.0	88.6	88.2	87.8	87.4	86.9	86.4	
85	89.1	89.1	89.1	89.1	89.1	89.1	89.0	89.0	88.8	88.7	88.5	88.3	88.0	87.7	87.4	87.1	86.8	86.4	
90	87.8	87.8	87.8	87.8	87.8	87.8	87.8	87.8	87.7	87.7	87.6	87.5	87.3	87.2	87.0	86.8	86.6	86.4	
95	86.7	86.7	86.7	86.7	86.7	86.7	86.7	86.7	86.7	86.7	86.7	86.7	86.6	86.6	86.6	86.5	86.5	86.4	
98	86.4	86.4	86.4	86.4	86.4	86.4	86.4	86.4	86.4	86.4	86.4	86.4	86.4	86.4	86.4	86.4	86.4	86.4	86.4



Mean Annual Mass Removal Efficiencies (%) for 2.75-inches of Retention for Zone 1

NDCIA CN	Percent DCIA																	
	0-15	20	25	30	35	40	45	50	55	60	65	70	75	80	85	90	95	100
30	99.3	99.3	99.2	99.0	98.6	98.2	97.5	96.9	96.2	95.4	94.6	93.8	92.9	92.0	91.1	90.2	89.3	88.3
35	98.9	98.9	98.9	98.7	98.4	97.9	97.3	96.7	96.0	95.2	94.5	93.6	92.8	91.9	91.1	90.2	89.2	88.3
40	98.5	98.5	98.5	98.4	98.0	97.6	97.0	96.4	95.7	95.0	94.3	93.5	92.7	91.8	91.0	90.1	89.2	88.3
45	98.1	98.1	98.1	97.9	97.6	97.1	96.6	96.1	95.4	94.8	94.1	93.3	92.5	91.7	90.9	90.1	89.2	88.3
50	97.6	97.6	97.6	97.4	97.0	96.6	96.2	95.6	95.1	94.5	93.8	93.1	92.4	91.6	90.8	90.0	89.2	88.3
55	96.9	96.9	96.9	96.7	96.4	96.0	95.6	95.1	94.6	94.1	93.5	92.8	92.1	91.4	90.7	89.9	89.1	88.3
60	96.1	96.1	96.0	95.9	95.7	95.3	95.0	94.6	94.1	93.6	93.1	92.5	91.9	91.2	90.5	89.8	89.1	88.3
65	95.1	95.1	95.1	95.0	94.8	94.6	94.3	93.9	93.6	93.1	92.6	92.1	91.5	90.9	90.3	89.7	89.0	88.3
70	94.0	94.0	94.0	94.0	93.9	93.7	93.5	93.2	92.9	92.5	92.1	91.7	91.2	90.7	90.1	89.5	88.9	88.3
75	92.9	92.9	92.9	92.9	92.9	92.8	92.6	92.4	92.2	91.9	91.5	91.1	90.7	90.3	89.9	89.4	88.9	88.3
80	91.8	91.8	91.8	91.8	91.8	91.8	91.7	91.5	91.3	91.1	90.9	90.6	90.3	89.9	89.6	89.2	88.8	88.3
85	90.6	90.6	90.6	90.6	90.6	90.6	90.6	90.5	90.4	90.3	90.1	89.9	89.7	89.5	89.2	89.0	88.7	88.3
90	89.5	89.5	89.5	89.5	89.5	89.5	89.5	89.5	89.4	89.4	89.3	89.2	89.1	89.0	88.9	88.7	88.5	88.3
95	88.5	88.5	88.5	88.5	88.5	88.5	88.5	88.5	88.5	88.5	88.5	88.5	88.5	88.5	88.5	88.4	88.4	88.3
98	88.3	88.3	88.3	88.3	88.3	88.3	88.3	88.3	88.3	88.3	88.3	88.3	88.3	88.3	88.3	88.3	88.3	88.3

Mean Annual Mass Removal Efficiencies (%) for 3.00-inches of Retention for Zone 1

NDCIA CN	Percent DCIA																	
	0-15	20	25	30	35	40	45	50	55	60	65	70	75	80	85	90	95	100
30	99.5	99.4	99.3	99.2	99.0	98.6	98.1	97.5	96.9	96.2	95.5	94.8	94.1	93.3	92.4	91.6	90.8	89.9
35	99.1	99.1	99.1	99.0	98.7	98.4	97.9	97.3	96.7	96.1	95.4	94.7	94.0	93.2	92.4	91.6	90.8	89.9
40	98.7	98.7	98.7	98.7	98.5	98.1	97.6	97.1	96.5	95.9	95.2	94.6	93.8	93.1	92.3	91.5	90.8	89.9
45	98.4	98.4	98.4	98.3	98.1	97.7	97.3	96.8	96.2	95.7	95.0	94.4	93.7	93.0	92.2	91.5	90.7	89.9
50	98.0	98.0	98.0	97.9	97.6	97.2	96.9	96.4	95.9	95.4	94.8	94.2	93.5	92.9	92.2	91.4	90.7	89.9
55	97.4	97.4	97.4	97.3	97.0	96.7	96.4	96.0	95.5	95.0	94.5	93.9	93.3	92.7	92.0	91.4	90.7	89.9
60	96.8	96.8	96.7	96.6	96.4	96.1	95.8	95.4	95.0	94.6	94.1	93.6	93.1	92.5	91.9	91.3	90.6	89.9
65	95.9	95.9	95.9	95.8	95.7	95.4	95.2	94.9	94.5	94.1	93.7	93.3	92.8	92.3	91.7	91.1	90.6	89.9
70	95.0	95.0	95.0	94.9	94.8	94.7	94.5	94.2	93.9	93.6	93.3	92.9	92.4	92.0	91.5	91.0	90.5	89.9
75	93.9	93.9	93.9	93.9	93.9	93.8	93.7	93.5	93.3	93.0	92.7	92.4	92.1	91.7	91.3	90.9	90.4	89.9
80	92.9	92.9	92.9	92.9	92.9	92.9	92.8	92.7	92.6	92.4	92.1	91.9	91.6	91.3	91.0	90.7	90.3	89.9
85	91.9	91.9	91.9	91.9	91.9	91.9	91.9	91.8	91.7	91.6	91.5	91.3	91.1	90.9	90.7	90.5	90.2	89.9
90	90.9	90.9	90.9	90.9	90.9	90.9	90.9	90.9	90.9	90.8	90.8	90.7	90.6	90.5	90.4	90.2	90.1	89.9
95	90.1	90.1	90.1	90.1	90.1	90.1	90.1	90.1	90.1	90.1	90.1	90.1	90.1	90.1	90.0	90.0	90.0	89.9
98	89.9	89.9	89.9	89.9	89.9	89.9	89.9	89.9	89.9	89.9	89.9	89.9	89.9	89.9	89.9	89.9	89.9	89.9



**Mean Annual Mass Removal Efficiencies (%) for 3.25-inches of Retention for Zone 1**

NDCIA CN	Percent DCIA																	
	0-15	20	25	30	35	40	45	50	55	60	65	70	75	80	85	90	95	100
30	99.6	99.5	99.5	99.4	99.2	98.9	98.5	98.1	97.5	96.9	96.3	95.7	95.0	94.3	93.6	92.8	92.1	91.3
35	99.3	99.2	99.2	99.1	99.0	98.7	98.3	97.9	97.3	96.8	96.2	95.6	94.9	94.2	93.5	92.8	92.0	91.3
40	98.9	98.9	98.9	98.9	98.7	98.5	98.1	97.7	97.2	96.6	96.0	95.4	94.8	94.1	93.5	92.7	92.0	91.3
45	98.6	98.6	98.6	98.6	98.4	98.2	97.8	97.4	96.9	96.4	95.8	95.3	94.7	94.0	93.4	92.7	92.0	91.3
50	98.3	98.3	98.3	98.2	98.1	97.8	97.4	97.0	96.6	96.1	95.6	95.1	94.5	93.9	93.3	92.6	92.0	91.3
55	97.9	97.9	97.9	97.8	97.6	97.3	97.0	96.6	96.2	95.8	95.3	94.8	94.3	93.8	93.2	92.6	91.9	91.3
60	97.3	97.3	97.3	97.2	97.0	96.8	96.5	96.2	95.8	95.4	95.0	94.6	94.1	93.6	93.0	92.5	91.9	91.3
65	96.6	96.6	96.6	96.5	96.3	96.2	95.9	95.6	95.3	95.0	94.6	94.2	93.8	93.4	92.9	92.4	91.8	91.3
70	95.7	95.7	95.7	95.7	95.6	95.5	95.3	95.1	94.8	94.5	94.2	93.9	93.5	93.1	92.7	92.2	91.8	91.3
75	94.8	94.8	94.8	94.8	94.8	94.7	94.6	94.4	94.2	94.0	93.8	93.5	93.2	92.8	92.5	92.1	91.7	91.3
80	93.9	93.9	93.9	93.9	93.9	93.9	93.8	93.7	93.6	93.4	93.2	93.0	92.8	92.5	92.2	91.9	91.6	91.3
85	93.0	93.0	93.0	93.0	93.0	93.0	93.0	92.9	92.9	92.8	92.6	92.5	92.3	92.2	92.0	91.8	91.5	91.3
90	92.1	92.1	92.1	92.1	92.1	92.1	92.1	92.1	92.1	92.1	92.0	91.9	91.9	91.8	91.7	91.6	91.4	91.3
95	91.4	91.4	91.4	91.4	91.4	91.4	91.4	91.4	91.4	91.4	91.4	91.4	91.4	91.4	91.4	91.4	91.3	91.3
98	91.3	91.3	91.3	91.3	91.3	91.3	91.3	91.3	91.3	91.3	91.3	91.3	91.3	91.3	91.3	91.3	91.3	91.3

**Mean Annual Mass Removal Efficiencies (%) for 3.50-inches of Retention for Zone 1**

NDCIA CN	Percent DCIA																	
	0-15	20	25	30	35	40	45	50	55	60	65	70	75	80	85	90	95	100
30	99.6	99.6	99.6	99.5	99.4	99.2	98.8	98.4	98.0	97.5	97.0	96.4	95.8	95.2	94.5	93.8	93.1	92.4
35	99.4	99.4	99.4	99.3	99.2	99.0	98.7	98.3	97.9	97.4	96.8	96.3	95.7	95.1	94.5	93.8	93.1	92.4
40	99.1	99.1	99.1	99.1	98.9	98.8	98.5	98.1	97.7	97.2	96.7	96.2	95.6	95.0	94.4	93.8	93.1	92.4
45	98.8	98.8	98.8	98.8	98.7	98.5	98.2	97.9	97.4	97.0	96.5	96.0	95.5	94.9	94.3	93.7	93.1	92.4
50	98.5	98.5	98.5	98.5	98.4	98.2	97.9	97.5	97.2	96.8	96.3	95.8	95.3	94.8	94.2	93.7	93.1	92.4
55	98.2	98.2	98.2	98.1	98.0	97.8	97.5	97.2	96.8	96.5	96.0	95.6	95.1	94.7	94.1	93.6	93.0	92.4
60	97.7	97.7	97.7	97.7	97.5	97.3	97.1	96.8	96.5	96.1	95.7	95.3	94.9	94.5	94.0	93.5	93.0	92.4
65	97.2	97.2	97.2	97.1	96.9	96.8	96.6	96.3	96.0	95.7	95.4	95.1	94.7	94.3	93.9	93.4	92.9	92.4
70	96.4	96.4	96.4	96.4	96.3	96.1	96.0	95.8	95.5	95.3	95.0	94.7	94.4	94.1	93.7	93.3	92.9	92.4
75	95.6	95.6	95.6	95.6	95.5	95.4	95.3	95.2	95.0	94.8	94.6	94.4	94.1	93.8	93.5	93.2	92.8	92.4
80	94.7	94.7	94.7	94.7	94.7	94.7	94.6	94.5	94.4	94.3	94.1	93.9	93.7	93.5	93.3	93.0	92.7	92.4
85	93.9	93.9	93.9	93.9	93.9	93.9	93.9	93.8	93.8	93.7	93.6	93.5	93.4	93.2	93.0	92.8	92.6	92.4
90	93.1	93.1	93.1	93.1	93.1	93.1	93.1	93.1	93.1	93.1	93.1	93.0	92.9	92.8	92.8	92.7	92.5	92.4
95	92.5	92.5	92.5	92.5	92.5	92.5	92.5	92.5	92.5	92.5	92.5	92.5	92.5	92.5	92.5	92.5	92.5	92.4
98	92.4	92.4	92.4	92.4	92.4	92.4	92.4	92.4	92.4	92.4	92.4	92.4	92.4	92.4	92.4	92.4	92.4	92.4



Mean Annual Mass Removal Efficiencies (%) for 3.75-inches of Retention for Zone 1

NDCIA CN	Percent DCIA																	
	0-15	20	25	30	35	40	45	50	55	60	65	70	75	80	85	90	95	100
30	99.7	99.7	99.7	99.6	99.5	99.4	99.1	98.8	98.4	98.0	97.5	97.0	96.4	95.9	95.3	94.7	94.1	93.4
35	99.5	99.5	99.5	99.4	99.3	99.2	99.0	98.6	98.3	97.8	97.4	96.9	96.4	95.8	95.2	94.6	94.0	93.4
40	99.3	99.3	99.2	99.2	99.1	99.0	98.8	98.5	98.1	97.7	97.2	96.8	96.3	95.7	95.2	94.6	94.0	93.4
45	99.0	99.0	99.0	99.0	98.9	98.8	98.6	98.3	97.9	97.5	97.1	96.6	96.1	95.6	95.1	94.6	94.0	93.4
50	98.7	98.7	98.7	98.7	98.6	98.5	98.3	98.0	97.7	97.3	96.9	96.5	96.0	95.5	95.0	94.5	94.0	93.4
55	98.4	98.4	98.4	98.4	98.3	98.2	97.9	97.7	97.4	97.0	96.6	96.3	95.8	95.4	94.9	94.5	93.9	93.4
60	98.1	98.1	98.1	98.1	98.0	97.8	97.5	97.3	97.0	96.7	96.4	96.0	95.6	95.2	94.8	94.4	93.9	93.4
65	97.6	97.6	97.6	97.6	97.4	97.3	97.1	96.9	96.6	96.4	96.1	95.7	95.4	95.1	94.7	94.3	93.9	93.4
70	97.0	97.0	97.0	97.0	96.9	96.7	96.6	96.4	96.2	96.0	95.7	95.4	95.2	94.9	94.5	94.2	93.8	93.4
75	96.3	96.3	96.3	96.3	96.2	96.1	96.0	95.9	95.7	95.5	95.3	95.1	94.9	94.6	94.4	94.1	93.7	93.4
80	95.5	95.5	95.5	95.5	95.5	95.4	95.4	95.3	95.2	95.0	94.9	94.7	94.6	94.4	94.2	93.9	93.7	93.4
85	94.7	94.7	94.7	94.7	94.7	94.7	94.7	94.7	94.6	94.5	94.4	94.3	94.2	94.1	93.9	93.8	93.6	93.4
90	94.0	94.0	94.0	94.0	94.0	94.0	94.0	94.0	94.0	94.0	93.9	93.9	93.8	93.8	93.7	93.6	93.5	93.4
95	93.5	93.5	93.5	93.5	93.5	93.5	93.5	93.5	93.5	93.5	93.5	93.5	93.5	93.5	93.5	93.5	93.4	93.4
98	93.4	93.4	93.4	93.4	93.4	93.4	93.4	93.4	93.4	93.4	93.4	93.4	93.4	93.4	93.4	93.4	93.4	93.4

Mean Annual Mass Removal Efficiencies (%) for 4.00-inches of Retention for Zone 1

NDCIA CN	Percent DCIA																	
	0-15	20	25	30	35	40	45	50	55	60	65	70	75	80	85	90	95	100
30	99.8	99.8	99.7	99.7	99.6	99.5	99.3	99.0	98.7	98.3	97.9	97.5	97.0	96.5	95.9	95.4	94.8	94.3
35	99.6	99.6	99.6	99.5	99.5	99.3	99.2	98.9	98.6	98.2	97.8	97.4	96.9	96.4	95.9	95.4	94.8	94.3
40	99.4	99.4	99.4	99.3	99.3	99.2	99.0	98.8	98.5	98.1	97.7	97.3	96.8	96.3	95.8	95.3	94.8	94.3
45	99.1	99.1	99.1	99.1	99.1	99.0	98.8	98.6	98.3	97.9	97.6	97.2	96.7	96.3	95.8	95.3	94.8	94.3
50	98.9	98.9	98.9	98.9	98.8	98.7	98.6	98.3	98.1	97.7	97.4	97.0	96.6	96.2	95.7	95.2	94.8	94.3
55	98.6	98.6	98.6	98.6	98.6	98.5	98.3	98.1	97.8	97.5	97.1	96.8	96.4	96.0	95.6	95.2	94.7	94.3
60	98.3	98.3	98.3	98.3	98.3	98.1	98.0	97.7	97.5	97.2	96.9	96.6	96.3	95.9	95.5	95.1	94.7	94.3
65	98.0	98.0	98.0	98.0	97.9	97.7	97.5	97.3	97.1	96.9	96.6	96.3	96.0	95.7	95.4	95.0	94.7	94.3
70	97.5	97.5	97.5	97.5	97.4	97.2	97.1	96.9	96.7	96.5	96.3	96.1	95.8	95.5	95.2	94.9	94.6	94.3
75	96.8	96.8	96.8	96.8	96.8	96.7	96.6	96.4	96.3	96.1	96.0	95.8	95.5	95.3	95.1	94.8	94.5	94.3
80	96.1	96.1	96.1	96.1	96.1	96.1	96.0	95.9	95.8	95.7	95.6	95.4	95.3	95.1	94.9	94.7	94.5	94.3
85	95.4	95.4	95.4	95.4	95.4	95.4	95.4	95.4	95.3	95.2	95.1	95.0	94.9	94.8	94.7	94.6	94.4	94.3
90	94.8	94.8	94.8	94.8	94.8	94.8	94.8	94.8	94.8	94.7	94.7	94.7	94.6	94.6	94.5	94.4	94.3	94.3
95	94.3	94.3	94.3	94.3	94.3	94.3	94.3	94.3	94.3	94.3	94.3	94.3	94.3	94.3	94.3	94.3	94.3	94.3
98	94.3	94.3	94.3	94.3	94.3	94.3	94.3	94.3	94.3	94.3	94.3	94.3	94.3	94.3	94.3	94.3	94.3	94.3



**Mean Annual Mass Removal Efficiencies (%) for 0.10-inches of Retention for Zone 2**

NDCIA CN	Percent DCIA																	
	0-15	20	25	30	35	40	45	50	55	60	65	70	75	80	85	90	95	100
30	53.7	44.6	38.0	33.1	29.3	26.3	23.9	21.9	20.1	18.7	17.4	16.3	15.3	14.5	13.7	13.0	12.4	11.8
35	53.0	44.2	37.8	32.9	29.2	26.2	23.8	21.8	20.1	18.6	17.4	16.3	15.3	14.5	13.7	13.0	12.4	11.8
40	52.1	43.6	37.4	32.7	29.0	26.1	23.7	21.8	20.1	18.6	17.3	16.3	15.3	14.4	13.7	13.0	12.4	11.8
45	50.8	42.9	36.9	32.4	28.8	25.9	23.6	21.7	20.0	18.5	17.3	16.2	15.3	14.4	13.7	13.0	12.4	11.8
50	49.3	41.9	36.3	31.9	28.5	25.7	23.4	21.5	19.9	18.5	17.2	16.2	15.2	14.4	13.7	13.0	12.4	11.8
55	47.3	40.7	35.5	31.4	28.1	25.4	23.2	21.4	19.8	18.4	17.2	16.1	15.2	14.4	13.6	13.0	12.4	11.8
60	45.0	39.2	34.5	30.6	27.6	25.0	22.9	21.2	19.6	18.2	17.1	16.1	15.1	14.3	13.6	13.0	12.4	11.8
65	42.2	37.4	33.2	29.7	26.9	24.5	22.6	20.9	19.4	18.1	16.9	16.0	15.1	14.3	13.6	12.9	12.4	11.8
70	39.0	35.1	31.6	28.6	26.1	23.9	22.1	20.5	19.1	17.9	16.8	15.8	15.0	14.2	13.5	12.9	12.4	11.8
75	35.3	32.5	29.7	27.1	25.0	23.1	21.4	20.0	18.7	17.6	16.5	15.7	14.9	14.1	13.5	12.9	12.3	11.8
80	31.0	29.2	27.2	25.3	23.5	21.9	20.5	19.3	18.2	17.1	16.2	15.4	14.7	14.0	13.4	12.8	12.3	11.8
85	26.2	25.4	24.2	22.9	21.6	20.4	19.3	18.3	17.4	16.5	15.8	15.0	14.4	13.8	13.2	12.7	12.3	11.8
90	21.1	20.9	20.5	19.8	19.1	18.3	17.6	16.9	16.2	15.6	15.0	14.5	14.0	13.5	13.0	12.6	12.2	11.8
95	16.2	16.2	16.1	15.9	15.7	15.4	15.1	14.8	14.5	14.1	13.8	13.5	13.2	12.9	12.6	12.4	12.1	11.8
98	13.8	13.8	13.7	13.6	13.5	13.4	13.2	13.1	13.0	12.9	12.7	12.6	12.5	12.3	12.2	12.1	12.0	11.8

**Mean Annual Mass Removal Efficiencies (%) for 0.20-inches of Retention for Zone 2**

NDCIA CN	Percent DCIA																	
	0-15	20	25	30	35	40	45	50	55	60	65	70	75	80	85	90	95	100
30	76.8	67.8	60.3	54.2	49.1	44.9	41.3	38.2	35.6	33.3	31.3	29.5	27.9	26.4	25.1	24.0	22.9	22.0
35	75.8	67.2	59.9	53.9	48.9	44.7	41.2	38.2	35.5	33.2	31.2	29.4	27.8	26.4	25.1	24.0	22.9	22.0
40	74.5	66.4	59.4	53.5	48.6	44.5	41.0	38.0	35.4	33.1	31.2	29.4	27.8	26.4	25.1	24.0	22.9	22.0
45	72.7	65.2	58.6	52.9	48.2	44.2	40.8	37.9	35.3	33.0	31.1	29.3	27.8	26.4	25.1	23.9	22.9	22.0
50	70.5	63.8	57.6	52.2	47.7	43.8	40.5	37.6	35.1	32.9	31.0	29.3	27.7	26.3	25.1	23.9	22.9	22.0
55	67.8	62.0	56.3	51.3	47.0	43.3	40.1	37.3	34.9	32.7	30.9	29.2	27.6	26.3	25.0	23.9	22.9	22.0
60	64.7	59.7	54.7	50.1	46.1	42.7	39.6	37.0	34.6	32.5	30.7	29.0	27.5	26.2	25.0	23.9	22.9	22.0
65	60.9	57.0	52.7	48.7	45.0	41.8	39.0	36.5	34.2	32.2	30.5	28.9	27.4	26.1	24.9	23.8	22.9	22.0
70	56.5	53.7	50.3	46.8	43.6	40.7	38.1	35.8	33.7	31.8	30.2	28.6	27.2	26.0	24.8	23.8	22.8	22.0
75	51.5	49.8	47.3	44.5	41.8	39.3	37.0	34.9	33.0	31.3	29.7	28.3	27.0	25.8	24.7	23.7	22.8	22.0
80	45.7	45.2	43.6	41.6	39.5	37.5	35.5	33.8	32.1	30.6	29.2	27.9	26.7	25.6	24.6	23.6	22.8	22.0
85	39.6	39.6	38.9	37.8	36.4	34.9	33.5	32.1	30.7	29.5	28.3	27.2	26.2	25.2	24.3	23.5	22.7	22.0
90	33.6	33.6	33.4	32.9	32.3	31.5	30.6	29.7	28.8	27.9	27.0	26.2	25.4	24.6	23.9	23.2	22.6	22.0
95	27.6	27.6	27.5	27.4	27.2	26.9	26.5	26.2	25.8	25.3	24.9	24.5	24.0	23.6	23.2	22.8	22.4	22.0
98	24.5	24.5	24.4	24.2	24.1	24.0	23.9	23.7	23.5	23.4	23.2	23.0	22.9	22.7	22.5	22.3	22.1	22.0



**Mean Annual Mass Removal Efficiencies (%) for 0.30-inches of Retention for Zone 2**

NDCIA CN	Percent DCIA																	
	0-15	20	25	30	35	40	45	50	55	60	65	70	75	80	85	90	95	100
30	87.2	80.6	74.1	68.1	62.9	58.3	54.3	50.8	47.7	45.0	42.5	40.3	38.3	36.5	34.8	33.3	32.0	30.7
35	86.2	79.9	73.6	67.8	62.7	58.2	54.2	50.7	47.6	44.9	42.5	40.3	38.3	36.5	34.8	33.3	31.9	30.7
40	84.7	78.9	72.9	67.3	62.3	57.9	54.0	50.6	47.5	44.8	42.4	40.2	38.2	36.4	34.8	33.3	31.9	30.7
45	82.8	77.5	71.9	66.6	61.8	57.5	53.7	50.3	47.3	44.7	42.3	40.1	38.2	36.4	34.8	33.3	31.9	30.7
50	80.5	75.9	70.7	65.7	61.1	57.0	53.3	50.0	47.1	44.5	42.1	40.0	38.1	36.3	34.7	33.3	31.9	30.7
55	77.7	73.8	69.2	64.6	60.2	56.3	52.8	49.6	46.8	44.3	42.0	39.9	38.0	36.3	34.7	33.2	31.9	30.7
60	74.3	71.3	67.3	63.1	59.1	55.5	52.1	49.1	46.4	44.0	41.7	39.7	37.9	36.2	34.6	33.2	31.9	30.7
65	70.4	68.2	65.0	61.3	57.8	54.4	51.3	48.5	45.9	43.6	41.4	39.5	37.7	36.0	34.5	33.1	31.9	30.7
70	65.8	64.6	62.1	59.1	56.0	53.0	50.2	47.6	45.2	43.0	41.0	39.2	37.5	35.9	34.4	33.1	31.8	30.7
75	60.6	60.2	58.6	56.3	53.8	51.2	48.8	46.5	44.3	42.3	40.5	38.7	37.1	35.6	34.3	33.0	31.8	30.7
80	55.0	55.0	54.2	52.7	50.8	48.9	46.9	45.0	43.1	41.3	39.7	38.1	36.7	35.3	34.0	32.8	31.7	30.7
85	49.2	49.2	48.9	48.1	47.0	45.7	44.3	42.8	41.3	39.9	38.6	37.2	36.0	34.8	33.7	32.6	31.6	30.7
90	43.0	43.0	43.0	42.6	42.1	41.4	40.6	39.7	38.8	37.8	36.8	35.9	35.0	34.0	33.1	32.3	31.5	30.7
95	36.7	36.7	36.7	36.6	36.4	36.1	35.8	35.4	35.0	34.6	34.1	33.7	33.2	32.7	32.2	31.7	31.2	30.7
98	33.5	33.4	33.3	33.2	33.1	32.9	32.8	32.6	32.5	32.3	32.1	31.9	31.7	31.5	31.3	31.1	30.9	30.7

**Mean Annual Mass Removal Efficiencies (%) for 0.40-inches of Retention for Zone 2**

NDCIA CN	Percent DCIA																	
	0-15	20	25	30	35	40	45	50	55	60	65	70	75	80	85	90	95	100
30	92.2	87.7	82.6	77.5	72.7	68.3	64.3	60.7	57.4	54.4	51.7	49.3	47.1	45.0	43.1	41.4	39.8	38.4
35	91.1	86.9	82.0	77.1	72.4	68.1	64.1	60.6	57.3	54.4	51.7	49.2	47.0	45.0	43.1	41.4	39.8	38.4
40	89.7	85.9	81.2	76.5	72.0	67.8	63.9	60.4	57.1	54.2	51.6	49.2	47.0	45.0	43.1	41.4	39.8	38.4
45	88.0	84.5	80.2	75.7	71.4	67.3	63.5	60.1	56.9	54.1	51.5	49.1	46.9	44.9	43.1	41.4	39.8	38.4
50	85.7	82.8	78.9	74.7	70.6	66.7	63.1	59.7	56.7	53.9	51.3	49.0	46.8	44.9	43.0	41.3	39.8	38.4
55	83.0	80.7	77.3	73.5	69.7	65.9	62.5	59.3	56.3	53.6	51.1	48.8	46.7	44.8	43.0	41.3	39.8	38.4
60	79.8	78.1	75.3	71.9	68.4	65.0	61.7	58.7	55.8	53.2	50.8	48.6	46.5	44.7	42.9	41.3	39.7	38.4
65	76.0	75.1	72.8	70.0	66.9	63.8	60.7	57.9	55.2	52.7	50.4	48.3	46.3	44.5	42.8	41.2	39.7	38.4
70	71.6	71.4	69.8	67.6	64.9	62.2	59.5	56.9	54.4	52.1	49.9	47.9	46.0	44.3	42.6	41.1	39.7	38.4
75	67.0	67.0	66.1	64.5	62.4	60.2	57.8	55.6	53.4	51.2	49.3	47.4	45.6	44.0	42.4	41.0	39.6	38.4
80	62.0	62.0	61.6	60.6	59.2	57.5	55.6	53.8	51.9	50.1	48.3	46.7	45.1	43.6	42.2	40.8	39.5	38.4
85	56.4	56.4	56.4	55.9	55.0	53.9	52.6	51.3	49.8	48.4	47.0	45.6	44.3	43.0	41.7	40.6	39.4	38.4
90	50.6	50.6	50.6	50.4	49.9	49.3	48.6	47.8	46.9	45.9	45.0	44.0	43.0	42.1	41.1	40.1	39.2	38.4
95	44.4	44.4	44.4	44.3	44.1	43.9	43.6	43.2	42.8	42.4	41.9	41.5	41.0	40.5	39.9	39.4	38.9	38.4
98	41.1	41.0	40.9	40.8	40.7	40.6	40.4	40.3	40.2	40.0	39.8	39.6	39.4	39.2	39.0	38.8	38.6	38.4



Mean Annual Mass Removal Efficiencies (%) for 0.50-inches of Retention for Zone 2

NDCIA	Percent DCIA																	
	CN	0-15	20	25	30	35	40	45	50	55	60	65	70	75	80	85	90	95
30	94.8	91.7	87.9	83.8	79.7	75.7	71.9	68.4	65.2	62.1	59.4	56.9	54.5	52.3	50.3	48.4	46.7	45.1
35	93.8	90.9	87.3	83.4	79.3	75.4	71.7	68.3	65.0	62.1	59.3	56.8	54.4	52.3	50.3	48.4	46.7	45.1
40	92.5	89.9	86.5	82.7	78.9	75.1	71.4	68.0	64.9	61.9	59.2	56.7	54.4	52.2	50.2	48.4	46.7	45.1
45	90.9	88.6	85.5	81.9	78.2	74.6	71.1	67.7	64.6	61.7	59.1	56.6	54.3	52.2	50.2	48.4	46.7	45.1
50	88.9	87.0	84.2	80.9	77.4	73.9	70.5	67.3	64.3	61.5	58.9	56.5	54.2	52.1	50.2	48.3	46.6	45.1
55	86.4	84.9	82.6	79.6	76.4	73.1	69.9	66.8	63.9	61.2	58.6	56.3	54.1	52.0	50.1	48.3	46.6	45.1
60	83.4	82.5	80.6	78.0	75.1	72.1	69.1	66.1	63.4	60.8	58.3	56.0	53.9	51.9	50.0	48.2	46.6	45.1
65	79.8	79.5	78.1	76.0	73.5	70.7	68.0	65.3	62.7	60.2	57.9	55.7	53.6	51.7	49.9	48.2	46.6	45.1
70	76.0	76.0	75.2	73.5	71.4	69.1	66.6	64.2	61.8	59.5	57.3	55.3	53.3	51.4	49.7	48.1	46.5	45.1
75	71.9	71.9	71.5	70.4	68.8	66.9	64.9	62.7	60.6	58.6	56.6	54.7	52.8	51.1	49.5	47.9	46.5	45.1
80	67.3	67.3	67.2	66.5	65.5	64.1	62.5	60.8	59.0	57.3	55.5	53.9	52.2	50.7	49.2	47.7	46.4	45.1
85	62.3	62.3	62.3	62.0	61.3	60.4	59.3	58.1	56.8	55.4	54.0	52.7	51.3	50.0	48.7	47.4	46.2	45.1
90	56.8	56.8	56.8	56.7	56.4	55.9	55.2	54.5	53.6	52.8	51.8	50.9	49.9	48.9	47.9	46.9	46.0	45.1
95	50.8	50.8	50.8	50.8	50.6	50.4	50.2	49.9	49.5	49.1	48.7	48.2	47.7	47.2	46.7	46.1	45.6	45.1
98	47.7	47.6	47.6	47.5	47.4	47.2	47.1	46.9	46.8	46.6	46.5	46.3	46.1	45.9	45.7	45.5	45.3	45.1

Mean Annual Mass Removal Efficiencies (%) for 0.60-inches of Retention for Zone 2

NDCIA	Percent DCIA																	
	CN	0-15	20	25	30	35	40	45	50	55	60	65	70	75	80	85	90	95
30	96.3	94.1	91.3	88.1	84.6	81.1	77.7	74.5	71.4	68.5	65.7	63.2	60.8	58.6	56.5	54.5	52.7	51.0
35	95.4	93.4	90.7	87.6	84.3	80.9	77.5	74.3	71.3	68.4	65.7	63.1	60.8	58.5	56.5	54.5	52.7	51.0
40	94.3	92.4	89.9	87.0	83.8	80.5	77.2	74.1	71.1	68.2	65.5	63.0	60.7	58.5	56.4	54.5	52.7	51.0
45	92.8	91.2	88.9	86.2	83.1	80.0	76.8	73.8	70.8	68.0	65.4	62.9	60.6	58.4	56.4	54.5	52.7	51.0
50	91.0	89.7	87.7	85.2	82.3	79.3	76.3	73.3	70.5	67.7	65.2	62.7	60.5	58.3	56.3	54.4	52.6	51.0
55	88.7	87.9	86.1	83.9	81.2	78.4	75.6	72.8	70.0	67.4	64.9	62.5	60.3	58.2	56.2	54.4	52.6	51.0
60	86.0	85.6	84.2	82.3	79.9	77.4	74.7	72.1	69.5	66.9	64.5	62.2	60.1	58.1	56.1	54.3	52.6	51.0
65	82.8	82.8	81.9	80.3	78.3	76.0	73.6	71.2	68.7	66.4	64.1	61.9	59.8	57.9	56.0	54.2	52.6	51.0
70	79.5	79.5	79.0	77.9	76.3	74.3	72.2	70.0	67.8	65.6	63.5	61.4	59.5	57.6	55.8	54.1	52.5	51.0
75	75.7	75.7	75.6	74.8	73.6	72.1	70.4	68.5	66.5	64.6	62.7	60.8	59.0	57.2	55.6	54.0	52.4	51.0
80	71.6	71.6	71.6	71.2	70.4	69.3	67.9	66.4	64.9	63.2	61.5	59.9	58.3	56.7	55.2	53.7	52.3	51.0
85	67.1	67.1	67.1	66.9	66.4	65.7	64.7	63.7	62.5	61.2	59.9	58.6	57.3	56.0	54.7	53.4	52.2	51.0
90	62.0	62.0	62.0	61.9	61.7	61.3	60.7	60.1	59.3	58.5	57.6	56.7	55.8	54.8	53.9	52.9	51.9	51.0
95	56.4	56.4	56.4	56.4	56.3	56.1	55.8	55.6	55.2	54.9	54.5	54.0	53.6	53.1	52.6	52.1	51.5	51.0
98	53.4	53.4	53.3	53.2	53.1	53.0	52.9	52.8	52.6	52.5	52.3	52.2	52.0	51.8	51.6	51.4	51.2	51.0



**Mean Annual Mass Removal Efficiencies (%) for 0.70-inches of Retention for Zone 2**

NDCIA CN	Percent DCIA																	
	0-15	20	25	30	35	40	45	50	55	60	65	70	75	80	85	90	95	100
30	97.2	95.6	93.5	91.0	88.2	85.2	82.2	79.3	76.4	73.6	71.0	68.5	66.1	63.9	61.8	59.8	58.0	56.2
35	96.4	95.0	93.0	90.5	87.8	84.9	82.0	79.1	76.3	73.5	70.9	68.5	66.1	63.9	61.8	59.8	58.0	56.2
40	95.4	94.2	92.2	89.9	87.3	84.5	81.7	78.8	76.1	73.4	70.8	68.4	66.0	63.8	61.8	59.8	58.0	56.2
45	94.1	93.0	91.3	89.2	86.7	84.0	81.2	78.5	75.8	73.1	70.6	68.2	65.9	63.8	61.7	59.8	57.9	56.2
50	92.5	91.6	90.1	88.2	85.9	83.3	80.7	78.0	75.4	72.9	70.4	68.1	65.8	63.7	61.7	59.7	57.9	56.2
55	90.4	89.9	88.7	86.9	84.8	82.5	80.0	77.5	74.9	72.5	70.1	67.8	65.6	63.5	61.6	59.7	57.9	56.2
60	88.0	87.8	86.9	85.4	83.5	81.4	79.1	76.7	74.4	72.0	69.7	67.5	65.4	63.4	61.5	59.6	57.9	56.2
65	85.3	85.3	84.6	83.5	81.9	80.0	78.0	75.8	73.6	71.4	69.3	67.1	65.1	63.2	61.3	59.5	57.8	56.2
70	82.3	82.3	82.0	81.2	79.9	78.4	76.6	74.6	72.6	70.6	68.6	66.6	64.7	62.9	61.1	59.4	57.8	56.2
75	78.8	78.8	78.8	78.3	77.4	76.2	74.7	73.1	71.4	69.6	67.8	66.0	64.2	62.5	60.8	59.2	57.7	56.2
80	75.2	75.2	75.2	74.9	74.3	73.4	72.3	71.0	69.6	68.1	66.6	65.0	63.5	62.0	60.5	59.0	57.6	56.2
85	71.1	71.1	71.1	71.0	70.6	70.0	69.2	68.3	67.3	66.1	64.9	63.7	62.4	61.2	59.9	58.7	57.4	56.2
90	66.4	66.4	66.4	66.4	66.2	65.9	65.4	64.8	64.2	63.4	62.6	61.8	60.9	60.0	59.0	58.1	57.2	56.2
95	61.2	61.2	61.2	61.2	61.1	61.0	60.8	60.5	60.2	59.9	59.5	59.1	58.7	58.2	57.7	57.2	56.7	56.2
98	58.5	58.4	58.4	58.3	58.2	58.1	58.0	57.9	57.7	57.6	57.5	57.3	57.1	57.0	56.8	56.6	56.4	56.2

**Mean Annual Mass Removal Efficiencies (%) for 0.80-inches of Retention for Zone 2**

NDCIA CN	Percent DCIA																	
	0-15	20	25	30	35	40	45	50	55	60	65	70	75	80	85	90	95	100
30	97.8	96.7	95.1	93.0	90.7	88.3	85.7	83.0	80.4	77.9	75.4	73.0	70.7	68.6	66.5	64.5	62.6	60.9
35	97.1	96.1	94.6	92.6	90.4	88.0	85.4	82.9	80.3	77.8	75.3	72.9	70.7	68.5	66.4	64.5	62.6	60.9
40	96.2	95.3	93.9	92.0	89.9	87.6	85.1	82.6	80.1	77.6	75.2	72.8	70.6	68.5	66.4	64.5	62.6	60.9
45	95.1	94.3	93.0	91.3	89.3	87.1	84.7	82.2	79.8	77.4	75.0	72.7	70.5	68.4	66.3	64.4	62.6	60.9
50	93.6	93.0	91.9	90.3	88.5	86.4	84.1	81.8	79.4	77.1	74.8	72.5	70.4	68.3	66.3	64.4	62.6	60.9
55	91.7	91.5	90.6	89.2	87.5	85.5	83.4	81.2	78.9	76.7	74.4	72.3	70.2	68.1	66.2	64.3	62.5	60.9
60	89.6	89.5	88.9	87.8	86.3	84.5	82.5	80.5	78.3	76.2	74.1	72.0	69.9	68.0	66.1	64.3	62.5	60.9
65	87.3	87.3	86.8	86.0	84.7	83.2	81.4	79.5	77.6	75.6	73.6	71.6	69.6	67.7	65.9	64.2	62.5	60.9
70	84.6	84.6	84.3	83.7	82.8	81.5	80.0	78.3	76.6	74.8	72.9	71.1	69.2	67.4	65.7	64.0	62.4	60.9
75	81.5	81.5	81.5	81.1	80.4	79.4	78.2	76.8	75.3	73.7	72.0	70.4	68.7	67.0	65.4	63.9	62.3	60.9
80	78.1	78.1	78.1	78.0	77.5	76.8	75.8	74.8	73.5	72.2	70.8	69.4	67.9	66.5	65.0	63.6	62.2	60.9
85	74.4	74.4	74.4	74.4	74.1	73.6	72.9	72.2	71.2	70.2	69.2	68.0	66.9	65.7	64.4	63.2	62.0	60.9
90	70.2	70.2	70.2	70.2	70.0	69.8	69.4	68.9	68.3	67.6	66.9	66.1	65.3	64.4	63.6	62.7	61.8	60.9
95	65.4	65.4	65.4	65.4	65.3	65.2	65.1	64.8	64.6	64.3	63.9	63.6	63.2	62.7	62.3	61.8	61.3	60.9
98	62.9	62.9	62.8	62.7	62.7	62.6	62.5	62.4	62.2	62.1	62.0	61.9	61.7	61.5	61.4	61.2	61.0	60.9



**Mean Annual Mass Removal Efficiencies (%) for 0.90-inches of Retention for Zone 2**

NDCIA CN	Percent DCIA																	
	0-15	20	25	30	35	40	45	50	55	60	65	70	75	80	85	90	95	100
30	98.2	97.4	96.1	94.5	92.6	90.6	88.3	86.0	83.7	81.3	79.0	76.8	74.6	72.5	70.5	68.6	66.7	65.0
35	97.6	96.8	95.7	94.1	92.5	90.3	88.1	85.8	83.5	81.2	78.9	76.7	74.6	72.5	70.5	68.6	66.7	65.0
40	96.8	96.2	95.1	93.6	91.8	89.9	87.8	85.6	83.3	81.0	78.8	76.6	74.5	72.4	70.4	68.5	66.7	65.0
45	95.8	95.3	94.3	92.9	91.2	89.4	87.4	85.2	83.0	80.8	78.6	76.5	74.4	72.3	70.4	68.5	66.7	65.0
50	94.5	94.1	93.2	92.0	90.5	88.7	86.8	84.8	82.6	80.5	78.4	76.3	74.2	72.2	70.3	68.5	66.7	65.0
55	92.8	92.7	92.0	90.9	89.5	87.9	86.1	84.2	82.2	80.1	78.1	76.0	74.0	72.1	70.2	68.4	66.6	65.0
60	90.9	90.9	90.5	89.6	88.4	86.9	85.3	83.4	81.5	79.6	77.7	75.7	73.8	71.9	70.1	68.3	66.6	65.0
65	88.8	88.8	88.6	87.9	86.9	85.7	84.2	82.5	80.8	79.0	77.2	75.3	73.5	71.7	69.9	68.2	66.5	65.0
70	86.4	86.4	86.3	85.8	85.1	84.0	82.8	81.4	79.8	78.2	76.5	74.8	73.1	71.4	69.7	68.1	66.5	65.0
75	83.7	83.7	83.7	83.4	82.8	82.0	81.0	79.8	78.5	77.1	75.6	74.1	72.5	71.0	69.4	67.9	66.4	65.0
80	80.6	80.6	80.6	80.5	80.2	79.6	78.8	77.9	76.8	75.7	74.4	73.1	71.8	70.4	69.0	67.6	66.3	65.0
85	77.2	77.2	77.2	77.2	77.0	76.6	76.1	75.4	74.6	73.7	72.8	71.7	70.7	69.6	68.4	67.3	66.1	65.0
90	73.4	73.4	73.4	73.4	73.3	73.1	72.8	72.4	71.8	71.3	70.6	69.9	69.2	68.4	67.5	66.7	65.8	65.0
95	69.1	69.1	69.1	69.1	69.0	68.9	68.8	68.6	68.4	68.1	67.8	67.5	67.1	66.7	66.3	65.9	65.4	65.0
98	66.8	66.8	66.7	66.7	66.6	66.5	66.4	66.3	66.2	66.1	66.0	65.9	65.7	65.6	65.4	65.3	65.1	65.0

**Mean Annual Mass Removal Efficiencies (%) for 1.00-inches of Retention for Zone 2**

NDCIA CN	Percent DCIA																	
	0-15	20	25	30	35	40	45	50	55	60	65	70	75	80	85	90	95	100
30	98.5	97.9	96.9	95.6	94.1	92.3	90.4	88.4	86.3	84.2	82.1	80.0	77.9	75.9	74.0	72.2	70.3	68.6
35	98.0	97.4	96.5	95.3	93.7	92.0	90.2	88.2	86.2	84.1	82.0	79.9	77.9	75.9	74.0	72.1	70.3	68.6
40	97.2	96.8	95.9	94.8	93.3	91.7	89.9	87.9	85.9	83.9	81.8	79.8	77.8	75.8	73.9	72.1	70.3	68.6
45	96.3	96.0	95.2	94.1	92.7	91.2	89.4	87.6	85.6	83.6	81.6	79.6	77.7	75.8	73.9	72.1	70.3	68.6
50	95.2	94.9	94.3	93.3	92.0	90.5	88.9	87.1	85.3	83.3	81.4	79.5	77.5	75.6	73.8	72.0	70.3	68.6
55	93.7	93.6	93.1	92.3	91.1	89.8	88.2	86.6	84.8	82.9	81.1	79.2	77.3	75.5	73.7	72.0	70.2	68.6
60	92.0	92.0	91.7	91.0	90.0	88.8	87.4	85.9	84.2	82.4	80.7	78.9	77.1	75.3	73.6	71.9	70.2	68.6
65	90.2	90.2	90.0	89.5	88.7	87.6	86.4	85.0	83.4	81.8	80.2	78.5	76.8	75.1	73.4	71.8	70.2	68.6
70	88.0	88.0	88.0	87.6	86.9	86.1	85.1	83.8	82.5	81.0	79.5	77.9	76.4	74.8	73.2	71.6	70.1	68.6
75	85.6	85.6	85.6	85.3	84.9	84.2	83.4	82.4	81.2	80.0	78.6	77.2	75.8	74.3	72.9	71.5	70.0	68.6
80	82.8	82.8	82.8	82.7	82.4	81.9	81.3	80.5	79.6	78.5	77.4	76.3	75.0	73.8	72.5	71.2	69.9	68.6
85	79.7	79.7	79.7	79.7	79.5	79.2	78.8	78.2	77.5	76.7	75.9	74.9	74.0	72.9	71.9	70.8	69.7	68.6
90	76.2	76.2	76.2	76.2	76.2	76.0	75.7	75.3	74.9	74.4	73.8	73.2	72.5	71.8	71.0	70.3	69.4	68.6
95	72.2	72.2	72.2	72.2	72.2	72.1	72.0	71.9	71.7	71.4	71.2	70.9	70.6	70.2	69.9	69.5	69.0	68.6
98	70.2	70.2	70.1	70.1	70.1	70.0	69.9	69.8	69.7	69.7	69.6	69.4	69.3	69.2	69.0	68.9	68.8	68.6



Mean Annual Mass Removal Efficiencies (%) for 1.25-inches of Retention for Zone 2

NDCIA	Percent DCIA																	
	CN	0-15	20	25	30	35	40	45	50	55	60	65	70	75	80	85	90	95
30	99.0	98.7	98.1	97.3	96.4	95.2	93.9	92.4	90.9	89.3	87.7	86.0	84.3	82.6	80.9	79.2	77.6	76.0
35	98.6	98.3	97.7	97.0	96.1	94.9	93.7	92.3	90.8	89.2	87.6	85.9	84.2	82.5	80.9	79.2	77.6	76.0
40	98.0	97.8	97.3	96.6	95.7	94.6	93.4	92.0	90.5	89.0	87.4	85.8	84.1	82.5	80.8	79.2	77.6	76.0
45	97.3	97.1	96.7	96.1	95.2	94.2	93.0	91.7	90.3	88.8	87.2	85.6	84.0	82.4	80.7	79.1	77.6	76.0
50	96.4	96.3	96.0	95.4	94.6	93.6	92.5	91.3	89.9	88.5	87.0	85.4	83.8	82.2	80.7	79.1	77.5	76.0
55	95.3	95.3	95.1	94.6	93.9	93.0	91.9	90.8	89.5	88.1	86.7	85.2	83.6	82.1	80.6	79.0	77.5	76.0
60	94.1	94.1	94.0	93.6	92.9	92.2	91.2	90.1	88.9	87.7	86.3	84.9	83.4	81.9	80.4	78.9	77.5	76.0
65	92.7	92.7	92.6	92.3	91.8	91.1	90.3	89.3	88.3	87.1	85.8	84.5	83.1	81.7	80.3	78.8	77.4	76.0
70	91.0	91.0	91.0	90.8	90.4	89.8	89.1	88.3	87.4	86.3	85.2	83.9	82.7	81.4	80.0	78.7	77.3	76.0
75	89.1	89.1	89.1	89.0	88.7	88.3	87.7	87.0	86.2	85.3	84.3	83.3	82.1	80.9	79.7	78.5	77.3	76.0
80	86.9	86.9	86.9	86.9	86.7	86.4	86.0	85.5	84.8	84.1	83.3	82.3	81.4	80.4	79.3	78.2	77.1	76.0
85	84.5	84.5	84.5	84.5	84.4	84.2	84.0	83.6	83.1	82.5	81.9	81.2	80.4	79.6	78.8	77.9	76.9	76.0
90	81.7	81.7	81.7	81.7	81.7	81.7	81.5	81.3	80.9	80.6	80.1	79.7	79.1	78.6	78.0	77.4	76.7	76.0
95	78.7	78.7	78.7	78.7	78.7	78.6	78.6	78.4	78.3	78.2	78.0	77.8	77.5	77.3	77.0	76.7	76.3	76.0
98	77.1	77.1	77.1	77.1	77.0	77.0	76.9	76.9	76.8	76.8	76.7	76.6	76.5	76.4	76.3	76.2	76.1	76.0

Mean Annual Mass Removal Efficiencies (%) for 1.50-inches of Retention for Zone 2

NDCIA	Percent DCIA																	
	CN	0-15	20	25	30	35	40	45	50	55	60	65	70	75	80	85	90	95
30	99.3	99.1	98.7	98.2	97.6	96.8	95.9	94.9	93.7	92.5	91.3	89.9	88.6	87.2	85.7	84.3	82.9	81.5
35	99.0	98.8	98.5	98.0	97.4	96.6	95.7	94.7	93.6	92.4	91.2	89.8	88.5	87.1	85.7	84.3	82.9	81.5
40	98.5	98.4	98.1	97.6	97.1	96.3	95.5	94.5	93.4	92.2	91.0	89.7	88.4	87.1	85.7	84.3	82.9	81.5
45	98.0	97.9	97.6	97.2	96.7	96.0	95.1	94.2	93.1	92.0	90.8	89.6	88.3	87.0	85.6	84.2	82.9	81.5
50	97.2	97.2	97.0	96.7	96.2	95.5	94.7	93.8	92.8	91.8	90.6	89.4	88.2	86.9	85.5	84.2	82.8	81.5
55	96.4	96.4	96.3	96.0	95.6	95.0	94.2	93.4	92.4	91.4	90.3	89.2	88.0	86.7	85.4	84.1	82.8	81.5
60	95.5	95.5	95.4	95.2	94.8	94.3	93.6	92.8	92.0	91.0	90.0	88.9	87.7	86.5	85.3	84.0	82.8	81.5
65	94.4	94.4	94.4	94.2	93.9	93.4	92.8	92.1	91.3	90.5	89.5	88.5	87.4	86.3	85.1	83.9	82.7	81.5
70	93.1	93.1	93.1	93.0	92.7	92.3	91.9	91.2	90.6	89.8	88.9	88.0	87.0	86.0	84.9	83.8	82.6	81.5
75	91.6	91.6	91.6	91.6	91.4	91.1	90.7	90.2	89.6	88.9	88.2	87.4	86.5	85.6	84.6	83.6	82.6	81.5
80	89.9	89.9	89.9	89.9	89.8	89.6	89.3	88.9	88.4	87.9	87.3	86.6	85.9	85.1	84.2	83.3	82.4	81.5
85	88.0	88.0	88.0	88.0	87.9	87.8	87.6	87.3	87.0	86.6	86.1	85.6	85.0	84.4	83.7	83.0	82.3	81.5
90	85.8	85.8	85.8	85.8	85.8	85.7	85.6	85.5	85.3	85.0	84.7	84.4	84.0	83.5	83.1	82.6	82.0	81.5
95	83.4	83.4	83.4	83.4	83.4	83.4	83.4	83.3	83.2	83.1	83.0	82.8	82.6	82.4	82.2	82.0	81.8	81.5
98	82.2	82.2	82.2	82.2	82.2	82.2	82.1	82.1	82.1	82.0	82.0	81.9	81.9	81.8	81.7	81.7	81.6	81.5



Mean Annual Mass Removal Efficiencies (%) for 1.75-inches of Retention for Zone 2

NDCIA CN	Percent DCIA																	
	0-15	20	25	30	35	40	45	50	55	60	65	70	75	80	85	90	95	100
30	99.5	99.4	99.1	98.8	98.3	97.8	97.2	96.4	95.6	94.6	93.6	92.6	91.5	90.4	89.2	88.0	86.8	85.6
35	99.2	99.1	98.9	98.6	98.1	97.6	97.0	96.3	95.4	94.5	93.5	92.5	91.4	90.3	89.2	88.0	86.8	85.6
40	98.9	98.8	98.6	98.3	97.9	97.4	96.8	96.1	95.3	94.4	93.4	92.4	91.4	90.3	89.1	88.0	86.8	85.6
45	98.4	98.4	98.2	97.9	97.5	97.1	96.5	95.8	95.0	94.2	93.2	92.3	91.2	90.2	89.1	87.9	86.8	85.6
50	97.8	97.8	97.7	97.5	97.1	96.7	96.2	95.5	94.8	93.9	93.0	92.1	91.1	90.1	89.0	87.9	86.7	85.6
55	97.2	97.2	97.1	96.9	96.6	96.2	95.7	95.1	94.4	93.6	92.8	91.9	90.9	89.9	88.9	87.8	86.7	85.6
60	96.4	96.4	96.4	96.3	96.0	95.7	95.2	94.6	94.0	93.3	92.5	91.6	90.7	89.8	88.8	87.7	86.7	85.6
65	95.6	95.6	95.6	95.5	95.3	95.0	94.5	94.0	93.4	92.8	92.1	91.3	90.4	89.5	88.6	87.6	86.6	85.6
70	94.6	94.6	94.6	94.5	94.4	94.1	93.7	93.3	92.8	92.2	91.5	90.8	90.1	89.3	88.4	87.5	86.6	85.6
75	93.4	93.4	93.4	93.4	93.3	93.1	92.8	92.4	92.0	91.5	90.9	90.3	89.6	88.9	88.2	87.3	86.5	85.6
80	92.0	92.0	92.0	92.0	92.0	91.9	91.6	91.3	91.0	90.6	90.1	89.6	89.1	88.5	87.8	87.1	86.4	85.6
85	90.5	90.5	90.5	90.5	90.5	90.4	90.3	90.1	89.8	89.5	89.2	88.8	88.4	87.9	87.4	86.8	86.2	85.6
90	88.8	88.8	88.8	88.8	88.8	88.7	88.7	88.6	88.4	88.2	88.0	87.8	87.5	87.2	86.8	86.4	86.0	85.6
95	86.9	86.9	86.9	86.9	86.9	86.9	86.9	86.8	86.8	86.7	86.7	86.6	86.4	86.3	86.1	86.0	85.8	85.6
98	86.1	86.1	86.1	86.1	86.1	86.0	86.0	86.0	86.0	86.0	85.9	85.9	85.9	85.8	85.8	85.7	85.6	85.6

Mean Annual Mass Removal Efficiencies (%) for 2.00-inches of Retention for Zone 2

NDCIA CN	Percent DCIA																	
	0-15	20	25	30	35	40	45	50	55	60	65	70	75	80	85	90	95	100
30	99.6	99.6	99.4	99.1	98.8	98.4	97.9	97.4	96.8	96.1	95.3	94.4	93.6	92.6	91.7	90.7	89.7	88.7
35	99.4	99.4	99.2	99.0	98.6	98.2	97.8	97.3	96.6	95.9	95.2	94.4	93.5	92.6	91.6	90.7	89.7	88.7
40	99.1	99.1	98.9	98.7	98.4	98.0	97.6	97.1	96.5	95.8	95.1	94.3	93.4	92.5	91.6	90.6	89.7	88.7
45	98.8	98.7	98.6	98.4	98.1	97.8	97.4	96.9	96.3	95.6	94.9	94.1	93.3	92.5	91.5	90.6	89.6	88.7
50	98.3	98.3	98.2	98.0	97.8	97.5	97.1	96.6	96.1	95.4	94.7	94.0	93.2	92.4	91.5	90.6	89.6	88.7
55	97.8	97.8	97.7	97.6	97.4	97.1	96.7	96.3	95.8	95.2	94.5	93.8	93.0	92.2	91.4	90.5	89.6	88.7
60	97.1	97.1	97.1	97.0	96.9	96.6	96.3	95.9	95.4	94.9	94.2	93.6	92.8	92.1	91.3	90.4	89.6	88.7
65	96.5	96.5	96.5	96.4	96.3	96.0	95.7	95.4	94.9	94.4	93.9	93.3	92.6	91.9	91.1	90.3	89.5	88.7
70	95.7	95.7	95.7	95.6	95.5	95.3	95.1	94.8	94.4	93.9	93.4	92.9	92.3	91.6	90.9	90.2	89.5	88.7
75	94.7	94.7	94.7	94.7	94.7	94.5	94.3	94.0	93.7	93.3	92.9	92.4	91.9	91.3	90.7	90.1	89.4	88.7
80	93.7	93.7	93.7	93.7	93.6	93.5	93.4	93.2	92.9	92.6	92.2	91.8	91.4	90.9	90.4	89.9	89.3	88.7
85	92.4	92.4	92.4	92.4	92.4	92.4	92.3	92.1	91.9	91.7	91.4	91.1	90.8	90.4	90.0	89.6	89.2	88.7
90	91.0	91.0	91.0	91.0	91.0	91.0	91.0	90.9	90.8	90.6	90.5	90.3	90.1	89.9	89.6	89.3	89.0	88.7
95	89.5	89.5	89.5	89.5	89.5	89.5	89.5	89.5	89.5	89.4	89.4	89.3	89.2	89.2	89.0	88.9	88.8	88.7
98	88.9	88.9	88.9	88.9	88.9	88.9	88.9	88.9	88.9	88.9	88.9	88.8	88.8	88.8	88.8	88.7	88.7	88.7



Mean Annual Mass Removal Efficiencies (%) for 2.25-inches of Retention for Zone 2

NDCIA	Percent DCIA																		
	CN	0-15	20	25	30	35	40	45	50	55	60	65	70	75	80	85	90	95	100
30	99.7	99.7	99.6	99.4	99.1	98.8	98.5	98.1	97.6	97.0	96.4	95.8	95.0	94.3	93.5	92.7	91.8	91.0	
35	99.6	99.5	99.4	99.2	99.0	98.7	98.3	97.9	97.5	96.9	96.3	95.7	95.0	94.3	93.5	92.7	91.8	91.0	
40	99.3	99.3	99.2	99.0	98.8	98.5	98.2	97.8	97.3	96.8	96.2	95.6	94.9	94.2	93.4	92.6	91.8	91.0	
45	99.0	99.0	98.9	98.8	98.6	98.3	98.0	97.6	97.2	96.7	96.1	95.5	94.8	94.1	93.4	92.6	91.8	91.0	
50	98.7	98.7	98.6	98.5	98.3	98.0	97.7	97.4	97.0	96.5	95.9	95.4	94.7	94.0	93.3	92.5	91.8	91.0	
55	98.2	98.2	98.2	98.1	97.9	97.7	97.4	97.1	96.7	96.3	95.8	95.2	94.6	93.9	93.2	92.5	91.7	91.0	
60	97.7	97.7	97.7	97.6	97.5	97.3	97.0	96.8	96.4	96.0	95.5	95.0	94.4	93.8	93.1	92.4	91.7	91.0	
65	97.1	97.1	97.1	97.1	97.0	96.8	96.6	96.3	96.0	95.6	95.2	94.7	94.2	93.6	93.0	92.3	91.7	91.0	
70	96.4	96.4	96.4	96.4	96.4	96.3	96.1	95.8	95.5	95.2	94.8	94.4	93.9	93.4	92.8	92.2	91.6	91.0	
75	95.7	95.7	95.7	95.7	95.7	95.6	95.4	95.2	95.0	94.7	94.4	94.0	93.6	93.1	92.6	92.1	91.5	91.0	
80	94.9	94.9	94.9	94.9	94.9	94.8	94.7	94.5	94.3	94.1	93.8	93.5	93.1	92.8	92.4	91.9	91.4	91.0	
85	93.9	93.9	93.9	93.9	93.9	93.8	93.8	93.7	93.5	93.4	93.1	92.9	92.6	92.4	92.0	91.7	91.3	91.0	
90	92.7	92.7	92.7	92.7	92.7	92.7	92.7	92.7	92.6	92.5	92.4	92.2	92.1	91.9	91.7	91.5	91.2	91.0	
95	91.6	91.6	91.6	91.6	91.6	91.6	91.6	91.5	91.5	91.5	91.5	91.4	91.4	91.3	91.2	91.1	91.1	91.0	
98	91.1	91.1	91.1	91.1	91.1	91.1	91.1	91.1	91.1	91.1	91.1	91.1	91.0	91.0	91.0	91.0	91.0	91.0	

Mean Annual Mass Removal Efficiencies (%) for 2.50-inches of Retention for Zone 2

NDCIA	Percent DCIA																		
	CN	0-15	20	25	30	35	40	45	50	55	60	65	70	75	80	85	90	95	100
30	99.8	99.8	99.7	99.6	99.4	99.1	98.8	98.5	98.1	97.7	97.2	96.7	96.1	95.5	94.9	94.2	93.5	92.7	
35	99.7	99.6	99.6	99.4	99.3	99.0	98.7	98.4	98.0	97.6	97.2	96.6	96.1	95.5	94.8	94.2	93.4	92.7	
40	99.5	99.5	99.4	99.3	99.1	98.9	98.6	98.3	97.9	97.5	97.1	96.6	96.0	95.4	94.8	94.1	93.4	92.7	
45	99.2	99.2	99.2	99.0	98.9	98.7	98.4	98.1	97.8	97.4	97.0	96.5	95.9	95.4	94.7	94.1	93.4	92.7	
50	98.9	98.9	98.9	98.8	98.6	98.4	98.2	97.9	97.6	97.2	96.8	96.4	95.8	95.3	94.7	94.1	93.4	92.7	
55	98.6	98.6	98.5	98.5	98.3	98.1	97.9	97.7	97.4	97.0	96.6	96.2	95.7	95.2	94.6	94.0	93.4	92.7	
60	98.1	98.1	98.1	98.1	97.9	97.8	97.6	97.4	97.1	96.8	96.4	96.0	95.6	95.1	94.5	93.9	93.3	92.7	
65	97.6	97.6	97.6	97.6	97.5	97.4	97.2	97.0	96.8	96.5	96.2	95.8	95.4	94.9	94.4	93.9	93.3	92.7	
70	97.1	97.1	97.1	97.1	97.0	96.9	96.8	96.6	96.4	96.1	95.8	95.5	95.1	94.7	94.2	93.8	93.3	92.7	
75	96.5	96.5	96.5	96.5	96.4	96.4	96.3	96.1	95.9	95.7	95.5	95.2	94.8	94.5	94.1	93.6	93.2	92.7	
80	95.8	95.8	95.8	95.8	95.8	95.7	95.7	95.5	95.4	95.2	95.0	94.8	94.5	94.2	93.8	93.5	93.1	92.7	
85	95.0	95.0	95.0	95.0	95.0	94.9	94.9	94.7	94.6	94.5	94.3	94.1	93.8	93.6	93.3	93.0	92.7		
90	94.1	94.1	94.1	94.1	94.1	94.1	94.1	94.0	94.0	93.9	93.8	93.7	93.6	93.4	93.3	93.1	92.9	92.7	
95	93.1	93.1	93.1	93.1	93.1	93.1	93.1	93.1	93.1	93.1	93.1	93.1	93.0	93.0	92.9	92.9	92.8	92.7	
98	92.8	92.8	92.8	92.8	92.8	92.8	92.8	92.8	92.8	92.8	92.8	92.8	92.8	92.8	92.7	92.7	92.7	92.7	



**Mean Annual Mass Removal Efficiencies (%) for 2.75-inches of Retention for Zone 2**

NDCIA CN	Percent DCIA																	
	0-15	20	25	30	35	40	45	50	55	60	65	70	75	80	85	90	95	100
30	99.9	99.8	99.8	99.7	99.5	99.4	99.1	98.8	98.5	98.2	97.8	97.4	96.9	96.4	95.9	95.3	94.7	94.1
35	99.7	99.7	99.7	99.6	99.4	99.3	99.0	98.8	98.5	98.1	97.8	97.4	96.9	96.4	95.9	95.3	94.7	94.1
40	99.6	99.6	99.5	99.4	99.3	99.1	98.9	98.6	98.4	98.0	97.7	97.3	96.8	96.4	95.8	95.3	94.7	94.1
45	99.4	99.4	99.3	99.2	99.1	98.9	98.7	98.5	98.2	97.9	97.6	97.2	96.8	96.3	95.8	95.2	94.7	94.1
50	99.2	99.2	99.1	99.0	98.9	98.7	98.6	98.3	98.1	97.8	97.5	97.1	96.7	96.2	95.7	95.2	94.7	94.1
55	98.8	98.8	98.8	98.7	98.6	98.5	98.3	98.1	97.9	97.6	97.3	97.0	96.6	96.1	95.7	95.2	94.6	94.1
60	98.5	98.5	98.5	98.4	98.3	98.2	98.0	97.9	97.6	97.4	97.1	96.8	96.4	96.0	95.6	95.1	94.6	94.1
65	98.1	98.1	98.1	98.0	98.0	97.9	97.7	97.6	97.4	97.2	96.9	96.6	96.2	95.9	95.5	95.0	94.6	94.1
70	97.6	97.6	97.6	97.6	97.5	97.5	97.4	97.2	97.1	96.9	96.6	96.3	96.0	95.7	95.3	94.9	94.5	94.1
75	97.1	97.1	97.1	97.1	97.0	97.0	96.9	96.8	96.7	96.5	96.3	96.1	95.8	95.5	95.2	94.8	94.5	94.1
80	96.5	96.5	96.5	96.5	96.5	96.5	96.4	96.3	96.2	96.1	95.9	95.7	95.5	95.3	95.0	94.7	94.4	94.1
85	95.8	95.8	95.8	95.8	95.8	95.8	95.8	95.8	95.7	95.6	95.5	95.3	95.2	95.0	94.8	94.6	94.3	94.1
90	95.1	95.1	95.1	95.1	95.1	95.1	95.1	95.1	95.1	95.0	94.9	94.9	94.8	94.6	94.5	94.4	94.2	94.1
95	94.4	94.4	94.4	94.4	94.4	94.4	94.4	94.4	94.4	94.4	94.4	94.3	94.3	94.3	94.2	94.2	94.1	94.1
98	94.1	94.1	94.1	94.1	94.1	94.1	94.1	94.1	94.1	94.1	94.1	94.1	94.1	94.1	94.1	94.1	94.1	94.1

**Mean Annual Mass Removal Efficiencies (%) for 3.00-inches of Retention for Zone 2**

NDCIA CN	Percent DCIA																	
	0-15	20	25	30	35	40	45	50	55	60	65	70	75	80	85	90	95	100
30	99.9	99.9	99.8	99.8	99.7	99.5	99.3	99.1	98.9	98.6	98.3	97.9	97.6	97.1	96.7	96.2	95.7	95.1
35	99.8	99.8	99.7	99.7	99.6	99.4	99.2	99.0	98.8	98.5	98.2	97.9	97.5	97.1	96.7	96.2	95.7	95.1
40	99.7	99.7	99.6	99.6	99.5	99.3	99.1	98.9	98.7	98.4	98.1	97.8	97.5	97.1	96.6	96.2	95.7	95.1
45	99.5	99.5	99.5	99.4	99.3	99.2	99.0	98.8	98.6	98.3	98.1	97.7	97.4	97.0	96.6	96.1	95.6	95.1
50	99.3	99.3	99.3	99.2	99.1	99.0	98.8	98.6	98.4	98.2	97.9	97.6	97.3	96.9	96.5	96.1	95.6	95.1
55	99.1	99.1	99.0	99.0	98.9	98.8	98.6	98.5	98.3	98.0	97.8	97.5	97.2	96.9	96.5	96.1	95.6	95.1
60	98.7	98.7	98.7	98.7	98.6	98.5	98.4	98.2	98.1	97.9	97.6	97.4	97.1	96.8	96.4	96.0	95.6	95.1
65	98.4	98.4	98.4	98.4	98.3	98.2	98.1	98.0	97.8	97.6	97.4	97.2	96.9	96.6	96.3	95.9	95.6	95.1
70	98.0	98.0	98.0	98.0	97.9	97.9	97.8	97.7	97.6	97.4	97.2	97.0	96.8	96.5	96.2	95.9	95.5	95.1
75	97.5	97.5	97.5	97.5	97.5	97.5	97.4	97.3	97.2	97.1	96.9	96.8	96.5	96.3	96.1	95.8	95.5	95.1
80	97.0	97.0	97.0	97.0	97.0	97.0	97.0	96.9	96.9	96.8	96.6	96.5	96.3	96.1	95.9	95.7	95.4	95.1
85	96.5	96.5	96.5	96.5	96.5	96.5	96.5	96.5	96.4	96.3	96.3	96.1	96.0	95.9	95.7	95.5	95.3	95.1
90	95.9	95.9	95.9	95.9	95.9	95.9	95.9	95.9	95.9	95.9	95.8	95.8	95.7	95.6	95.5	95.4	95.3	95.1
95	95.4	95.4	95.4	95.4	95.4	95.4	95.4	95.4	95.4	95.4	95.3	95.3	95.3	95.3	95.3	95.2	95.2	95.1
98	95.2	95.2	95.2	95.2	95.2	95.2	95.2	95.2	95.2	95.2	95.2	95.2	95.2	95.2	95.1	95.1	95.1	95.1



**Mean Annual Mass Removal Efficiencies (%) for 3.25-inches of Retention for Zone 2**

NDCIA	Percent DCIA																		
	CN	0-15	20	25	30	35	40	45	50	55	60	65	70	75	80	85	90	95	100
30	99.9	99.9	99.9	99.8	99.8	99.6	99.5	99.3	99.1	98.9	98.6	98.3	98.0	97.7	97.3	96.9	96.4	96.0	
35	99.9	99.8	99.8	99.8	99.7	99.6	99.4	99.2	99.0	98.8	98.5	98.3	98.0	97.6	97.3	96.9	96.4	96.0	
40	99.7	99.7	99.7	99.7	99.6	99.5	99.3	99.1	99.0	98.7	98.5	98.2	97.9	97.6	97.2	96.8	96.4	96.0	
45	99.6	99.6	99.6	99.5	99.4	99.3	99.2	99.0	98.8	98.6	98.4	98.2	97.9	97.5	97.2	96.8	96.4	96.0	
50	99.4	99.4	99.4	99.4	99.3	99.2	99.1	98.9	98.7	98.5	98.3	98.1	97.8	97.5	97.2	96.8	96.4	96.0	
55	99.2	99.2	99.2	99.2	99.1	99.0	98.9	98.7	98.6	98.4	98.2	98.0	97.7	97.4	97.1	96.8	96.4	96.0	
60	99.0	99.0	99.0	98.9	98.9	98.8	98.7	98.5	98.4	98.2	98.0	97.8	97.6	97.3	97.0	96.7	96.4	96.0	
65	98.7	98.7	98.7	98.6	98.6	98.5	98.4	98.3	98.2	98.0	97.9	97.7	97.5	97.2	96.9	96.7	96.3	96.0	
70	98.3	98.3	98.3	98.3	98.3	98.2	98.2	98.1	98.0	97.8	97.7	97.5	97.3	97.1	96.8	96.6	96.3	96.0	
75	97.9	97.9	97.9	97.9	97.9	97.9	97.8	97.8	97.7	97.6	97.4	97.3	97.1	96.9	96.7	96.5	96.3	96.0	
80	97.5	97.5	97.5	97.5	97.5	97.5	97.5	97.4	97.4	97.3	97.2	97.1	96.9	96.8	96.6	96.4	96.2	96.0	
85	97.1	97.1	97.1	97.1	97.1	97.1	97.1	97.0	97.0	96.9	96.9	96.8	96.7	96.6	96.4	96.3	96.1	96.0	
90	96.6	96.6	96.6	96.6	96.6	96.6	96.6	96.6	96.6	96.6	96.5	96.5	96.4	96.3	96.3	96.2	96.1	96.0	
95	96.1	96.1	96.1	96.1	96.1	96.1	96.1	96.1	96.1	96.1	96.1	96.1	96.1	96.1	96.1	96.0	96.0	96.0	
98	96.0	96.0	96.0	96.0	96.0	96.0	96.0	96.0	96.0	96.0	96.0	96.0	96.0	96.0	96.0	96.0	96.0	96.0	

**Mean Annual Mass Removal Efficiencies (%) for 3.50-inches of Retention for Zone 2**

NDCIA	Percent DCIA																		
	CN	0-15	20	25	30	35	40	45	50	55	60	65	70	75	80	85	90	95	100
30	99.9	99.9	99.9	99.9	99.8	99.7	99.6	99.5	99.3	99.1	98.9	98.6	98.4	98.1	97.8	97.4	97.0	96.7	
35	99.9	99.9	99.8	99.8	99.8	99.7	99.5	99.4	99.2	99.0	98.8	98.6	98.3	98.0	97.7	97.4	97.0	96.7	
40	99.8	99.8	99.8	99.7	99.7	99.6	99.5	99.3	99.2	99.0	98.8	98.5	98.3	98.0	97.7	97.4	97.0	96.7	
45	99.7	99.7	99.7	99.6	99.6	99.5	99.4	99.2	99.1	98.9	98.7	98.5	98.2	98.0	97.7	97.4	97.0	96.7	
50	99.5	99.5	99.5	99.5	99.4	99.3	99.2	99.1	98.9	98.8	98.6	98.4	98.2	97.9	97.6	97.3	97.0	96.7	
55	99.4	99.4	99.4	99.3	99.3	99.2	99.1	99.0	98.8	98.7	98.5	98.3	98.1	97.9	97.6	97.3	97.0	96.7	
60	99.2	99.2	99.2	99.1	99.1	99.0	98.9	98.8	98.7	98.5	98.4	98.2	98.0	97.8	97.5	97.3	97.0	96.7	
65	98.9	98.9	98.9	98.9	98.8	98.8	98.7	98.6	98.5	98.4	98.2	98.1	97.9	97.7	97.5	97.2	96.9	96.7	
70	98.6	98.6	98.6	98.6	98.6	98.5	98.4	98.4	98.3	98.2	98.0	97.9	97.7	97.6	97.4	97.2	96.9	96.7	
75	98.3	98.3	98.3	98.3	98.2	98.2	98.2	98.1	98.0	97.9	97.8	97.7	97.6	97.4	97.3	97.1	96.9	96.7	
80	97.9	97.9	97.9	97.9	97.9	97.9	97.9	97.8	97.8	97.7	97.6	97.5	97.4	97.3	97.2	97.0	96.8	96.7	
85	97.5	97.5	97.5	97.5	97.5	97.5	97.5	97.5	97.5	97.4	97.4	97.3	97.2	97.1	97.0	96.9	96.8	96.7	
90	97.1	97.1	97.1	97.1	97.1	97.1	97.1	97.1	97.1	97.1	97.1	97.0	97.0	96.9	96.9	96.8	96.7	96.7	
95	96.8	96.8	96.8	96.8	96.8	96.8	96.8	96.8	96.8	96.8	96.8	96.8	96.7	96.7	96.7	96.7	96.7	96.7	
98	96.7	96.7	96.7	96.7	96.7	96.7	96.7	96.7	96.7	96.7	96.7	96.7	96.7	96.7	96.7	96.7	96.7	96.7	



**Mean Annual Mass Removal Efficiencies (%) for 3.75-inches of Retention for Zone 2**

NDCIA CN	Percent DCIA																	
	0-15	20	25	30	35	40	45	50	55	60	65	70	75	80	85	90	95	100
30	100.0	100.0	99.9	99.9	99.9	99.8	99.7	99.6	99.4	99.3	99.1	98.9	98.6	98.4	98.1	97.8	97.5	97.2
35	99.9	99.9	99.9	99.9	99.8	99.7	99.6	99.5	99.4	99.2	99.0	98.8	98.6	98.4	98.1	97.8	97.5	97.2
40	99.9	99.8	99.8	99.8	99.7	99.7	99.6	99.5	99.3	99.2	99.0	98.8	98.6	98.3	98.1	97.8	97.5	97.2
45	99.8	99.7	99.7	99.7	99.7	99.6	99.5	99.4	99.2	99.1	98.9	98.7	98.5	98.3	98.1	97.8	97.5	97.2
50	99.6	99.6	99.6	99.6	99.5	99.5	99.4	99.3	99.1	99.0	98.8	98.7	98.5	98.3	98.0	97.8	97.5	97.2
55	99.5	99.5	99.5	99.5	99.4	99.3	99.2	99.1	99.0	98.9	98.7	98.6	98.4	98.2	98.0	97.7	97.5	97.2
60	99.3	99.3	99.3	99.3	99.2	99.2	99.1	99.0	98.9	98.8	98.6	98.5	98.3	98.1	97.9	97.7	97.5	97.2
65	99.1	99.1	99.1	99.1	99.0	99.0	98.9	98.8	98.7	98.6	98.5	98.4	98.2	98.0	97.9	97.7	97.4	97.2
70	98.8	98.8	98.8	98.8	98.8	98.8	98.7	98.6	98.5	98.5	98.3	98.2	98.1	98.0	97.8	97.6	97.4	97.2
75	98.5	98.5	98.5	98.5	98.5	98.5	98.4	98.4	98.3	98.3	98.2	98.1	98.0	97.8	97.7	97.6	97.4	97.2
80	98.2	98.2	98.2	98.2	98.2	98.2	98.2	98.1	98.1	98.0	98.0	97.9	97.8	97.7	97.6	97.5	97.3	97.2
85	97.9	97.9	97.9	97.9	97.9	97.9	97.9	97.9	97.8	97.8	97.8	97.7	97.6	97.6	97.5	97.4	97.3	97.2
90	97.5	97.5	97.5	97.5	97.5	97.5	97.5	97.5	97.5	97.5	97.5	97.5	97.5	97.4	97.4	97.3	97.3	97.2
95	97.3	97.3	97.3	97.3	97.3	97.3	97.3	97.3	97.3	97.3	97.3	97.3	97.3	97.3	97.2	97.2	97.2	97.2
98	97.2	97.2	97.2	97.2	97.2	97.2	97.2	97.2	97.2	97.2	97.2	97.2	97.2	97.2	97.2	97.2	97.2	97.2

**Mean Annual Mass Removal Efficiencies (%) for 4.00-inches of Retention for Zone 2**

NDCIA CN	Percent DCIA																	
	0-15	20	25	30	35	40	45	50	55	60	65	70	75	80	85	90	95	100
30	100.0	100.0	100.0	99.9	99.9	99.8	99.8	99.7	99.6	99.4	99.3	99.1	98.9	98.7	98.4	98.2	97.9	97.6
35	99.9	99.9	99.9	99.9	99.9	99.8	99.7	99.6	99.5	99.4	99.2	99.0	98.8	98.6	98.4	98.2	97.9	97.6
40	99.9	99.9	99.9	99.8	99.8	99.7	99.7	99.6	99.5	99.3	99.2	99.0	98.8	98.6	98.4	98.2	97.9	97.6
45	99.8	99.8	99.8	99.8	99.7	99.7	99.6	99.5	99.4	99.3	99.1	98.9	98.8	98.6	98.4	98.1	97.9	97.6
50	99.7	99.7	99.7	99.7	99.6	99.6	99.5	99.4	99.3	99.2	99.0	98.9	98.7	98.5	98.3	98.1	97.9	97.6
55	99.6	99.6	99.6	99.6	99.5	99.4	99.4	99.3	99.2	99.1	98.9	98.8	98.6	98.5	98.3	98.1	97.9	97.6
60	99.4	99.4	99.4	99.4	99.4	99.3	99.2	99.2	99.1	99.0	98.8	98.7	98.6	98.4	98.2	98.1	97.8	97.6
65	99.3	99.3	99.3	99.2	99.2	99.1	99.1	99.0	98.9	98.8	98.7	98.6	98.5	98.3	98.2	98.0	97.8	97.6
70	99.0	99.0	99.0	99.0	99.0	99.0	98.9	98.8	98.8	98.7	98.6	98.5	98.4	98.3	98.1	98.0	97.8	97.6
75	98.8	98.8	98.8	98.8	98.8	98.7	98.7	98.6	98.6	98.5	98.4	98.4	98.3	98.2	98.0	97.9	97.8	97.6
80	98.5	98.5	98.5	98.5	98.5	98.5	98.4	98.4	98.4	98.3	98.3	98.2	98.1	98.1	98.0	97.9	97.7	97.6
85	98.2	98.2	98.2	98.2	98.2	98.2	98.2	98.2	98.1	98.1	98.1	98.0	98.0	97.9	97.9	97.8	97.7	97.6
90	97.9	97.9	97.9	97.9	97.9	97.9	97.9	97.9	97.9	97.9	97.9	97.9	97.8	97.8	97.8	97.7	97.7	97.6
95	97.7	97.7	97.7	97.7	97.7	97.7	97.7	97.7	97.7	97.7	97.7	97.7	97.7	97.7	97.7	97.6	97.6	97.6
98	97.6	97.6	97.6	97.6	97.6	97.6	97.6	97.6	97.6	97.6	97.6	97.6	97.6	97.6	97.6	97.6	97.6	97.6



Mean Annual Mass Removal Efficiencies (%) for 0.10-inches of Retention for Zone 3

NDCIA CN	Percent DCIA																	
	0-15	20	25	30	35	40	45	50	55	60	65	70	75	80	85	90	95	100
30	50.3	42.8	37.2	32.8	29.4	26.6	24.3	22.3	20.7	19.3	18.0	16.9	16.0	15.1	14.3	13.7	13.0	12.5
35	49.1	42.0	36.7	32.5	29.1	26.4	24.1	22.2	20.6	19.2	18.0	16.9	15.9	15.1	14.3	13.6	13.0	12.5
40	47.6	41.1	36.1	32.1	28.8	26.2	24.0	22.1	20.5	19.1	17.9	16.9	15.9	15.1	14.3	13.6	13.0	12.5
45	46.0	40.1	35.4	31.6	28.5	25.9	23.8	22.0	20.4	19.0	17.9	16.8	15.9	15.1	14.3	13.6	13.0	12.5
50	44.1	38.9	34.5	31.0	28.0	25.6	23.5	21.8	20.3	18.9	17.8	16.7	15.8	15.0	14.3	13.6	13.0	12.5
55	42.0	37.5	33.6	30.3	27.5	25.2	23.2	21.6	20.1	18.8	17.7	16.7	15.8	15.0	14.3	13.6	13.0	12.5
60	39.6	35.9	32.4	29.5	26.9	24.8	22.9	21.3	19.9	18.6	17.5	16.6	15.7	14.9	14.2	13.6	13.0	12.5
65	37.0	34.1	31.1	28.5	26.2	24.2	22.5	21.0	19.6	18.4	17.4	16.5	15.6	14.9	14.2	13.6	13.0	12.5
70	34.2	32.0	29.6	27.3	25.3	23.5	22.0	20.6	19.3	18.2	17.2	16.3	15.5	14.8	14.1	13.5	13.0	12.5
75	31.1	29.6	27.8	26.0	24.3	22.7	21.3	20.0	18.9	17.9	17.0	16.1	15.4	14.7	14.1	13.5	12.9	12.5
80	27.7	26.9	25.7	24.3	22.9	21.6	20.5	19.4	18.4	17.5	16.6	15.9	15.2	14.6	14.0	13.4	12.9	12.5
85	23.9	23.8	23.1	22.2	21.2	20.3	19.3	18.5	17.7	16.9	16.2	15.5	14.9	14.4	13.8	13.3	12.9	12.5
90	20.0	20.0	19.9	19.5	19.0	18.4	17.8	17.2	16.6	16.0	15.5	15.0	14.5	14.0	13.6	13.2	12.8	12.5
95	16.0	16.0	16.0	16.0	15.8	15.7	15.4	15.2	14.9	14.6	14.3	14.1	13.8	13.5	13.2	13.0	12.7	12.5
98	14.0	14.0	14.0	13.9	13.8	13.8	13.7	13.6	13.5	13.4	13.3	13.2	13.0	12.9	12.8	12.7	12.6	12.5

Mean Annual Mass Removal Efficiencies (%) for 0.20-inches of Retention for Zone 3

NDCIA CN	Percent DCIA																	
	0-15	20	25	30	35	40	45	50	55	60	65	70	75	80	85	90	95	100
30	69.9	63.0	57.0	51.9	47.6	43.8	40.7	37.9	35.5	33.4	31.5	29.8	28.3	26.9	25.7	24.6	23.5	22.6
35	68.2	61.9	56.2	51.3	47.2	43.5	40.4	37.7	35.4	33.3	31.4	29.7	28.2	26.9	25.7	24.5	23.5	22.6
40	66.2	60.6	55.3	50.7	46.7	43.2	40.1	37.5	35.2	33.1	31.3	29.7	28.2	26.9	25.6	24.5	23.5	22.6
45	63.9	59.0	54.2	49.9	46.1	42.7	39.8	37.3	35.0	33.0	31.2	29.6	28.1	26.8	25.6	24.5	23.5	22.6
50	61.3	57.2	53.0	49.0	45.4	42.2	39.4	36.9	34.8	32.8	31.1	29.5	28.0	26.7	25.6	24.5	23.5	22.6
55	58.4	55.2	51.5	47.9	44.6	41.6	38.9	36.6	34.5	32.6	30.9	29.3	27.9	26.7	25.5	24.5	23.5	22.6
60	55.3	52.9	49.7	46.6	43.6	40.8	38.3	36.1	34.1	32.3	30.7	29.2	27.8	26.6	25.5	24.4	23.5	22.6
65	51.8	50.3	47.8	45.0	42.4	39.9	37.6	35.6	33.7	32.0	30.4	29.0	27.7	26.5	25.4	24.4	23.4	22.6
70	48.1	47.3	45.5	43.3	41.0	38.8	36.8	34.9	33.1	31.5	30.1	28.7	27.5	26.3	25.3	24.3	23.4	22.6
75	44.0	44.0	42.8	41.1	39.3	37.5	35.7	34.0	32.5	31.0	29.7	28.4	27.2	26.2	25.2	24.2	23.4	22.6
80	40.1	40.1	39.6	38.5	37.2	35.8	34.3	32.9	31.6	30.3	29.1	28.0	26.9	25.9	25.0	24.1	23.3	22.6
85	35.8	35.8	35.8	35.3	34.5	33.5	32.5	31.4	30.3	29.3	28.3	27.3	26.4	25.6	24.8	24.0	23.3	22.6
90	31.3	31.3	31.3	31.3	31.0	30.5	29.9	29.3	28.6	27.8	27.1	26.4	25.7	25.0	24.4	23.8	23.2	22.6
95	26.6	26.6	26.6	26.6	26.6	26.5	26.3	26.1	25.8	25.5	25.2	24.8	24.5	24.1	23.7	23.3	22.9	22.6
98	24.3	24.3	24.3	24.2	24.2	24.1	24.1	24.0	23.9	23.7	23.6	23.5	23.3	23.2	23.0	22.9	22.7	22.6



Mean Annual Mass Removal Efficiencies (%) for 0.30-inches of Retention for Zone 3

NDCIA CN	Percent DCIA																	
	0-15	20	25	30	35	40	45	50	55	60	65	70	75	80	85	90	95	100
30	79.5	74.0	68.8	64.0	59.7	55.9	52.5	49.4	46.7	44.2	42.0	40.0	38.2	36.5	35.0	33.6	32.3	31.1
35	77.6	72.7	67.9	63.3	59.2	55.5	52.2	49.2	46.5	44.1	41.9	39.9	38.1	36.5	34.9	33.5	32.3	31.1
40	75.3	71.2	66.7	62.5	58.6	55.0	51.8	48.9	46.3	43.9	41.7	39.8	38.0	36.4	34.9	33.5	32.2	31.1
45	72.8	69.4	65.4	61.5	57.9	54.4	51.4	48.6	46.0	43.7	41.6	39.7	37.9	36.3	34.9	33.5	32.2	31.1
50	70.0	67.3	63.9	60.4	57.0	53.8	50.8	48.2	45.7	43.5	41.4	39.5	37.8	36.3	34.8	33.5	32.2	31.1
55	66.8	64.9	62.1	59.0	55.9	53.0	50.2	47.7	45.3	43.2	41.2	39.4	37.7	36.2	34.7	33.4	32.2	31.1
60	63.3	62.3	60.1	57.5	54.7	52.0	49.5	47.1	44.9	42.8	40.9	39.1	37.5	36.0	34.7	33.4	32.2	31.1
65	59.8	59.4	57.8	55.7	53.3	50.9	48.6	46.4	44.3	42.3	40.5	38.9	37.3	35.9	34.6	33.3	32.2	31.1
70	56.0	56.0	55.1	53.5	51.6	49.5	47.5	45.5	43.6	41.8	40.1	38.5	37.1	35.7	34.4	33.2	32.1	31.1
75	52.3	52.3	52.0	51.0	49.5	47.8	46.1	44.4	42.7	41.1	39.5	38.1	36.8	35.5	34.3	33.1	32.1	31.1
80	48.3	48.3	48.3	47.9	46.9	45.7	44.3	42.9	41.5	40.1	38.8	37.5	36.3	35.1	34.0	33.0	32.0	31.1
85	44.1	44.1	44.1	44.1	43.7	42.9	42.0	41.0	39.9	38.9	37.8	36.7	35.7	34.7	33.7	32.8	31.9	31.1
90	39.7	39.7	39.7	39.7	39.6	39.3	38.9	38.3	37.7	37.0	36.2	35.5	34.7	34.0	33.2	32.5	31.8	31.1
95	35.0	35.0	35.0	35.0	35.0	35.0	34.8	34.7	34.4	34.1	33.8	33.5	33.1	32.7	32.3	31.9	31.5	31.1
98	32.6	32.6	32.6	32.6	32.6	32.5	32.5	32.4	32.3	32.2	32.1	32.0	31.8	31.7	31.6	31.4	31.2	31.1

Mean Annual Mass Removal Efficiencies (%) for 0.40-inches of Retention for Zone 3

NDCIA CN	Percent DCIA																	
	0-15	20	25	30	35	40	45	50	55	60	65	70	75	80	85	90	95	100
30	84.5	80.7	76.4	72.1	68.2	64.5	61.2	58.1	55.3	52.8	50.4	48.2	46.2	44.4	42.7	41.1	39.7	38.3
35	82.5	79.3	75.3	71.3	67.6	64.1	60.8	57.9	55.1	52.6	50.3	48.1	46.2	44.3	42.7	41.1	39.6	38.3
40	80.2	77.6	74.1	70.4	66.9	63.5	60.4	57.5	54.8	52.4	50.1	48.0	46.1	44.3	42.6	41.1	39.6	38.3
45	77.7	75.7	72.7	69.3	66.1	62.9	59.9	57.1	54.5	52.1	49.9	47.9	46.0	44.2	42.6	41.0	39.6	38.3
50	74.8	73.6	71.0	68.0	65.1	62.1	59.3	56.6	54.1	51.8	49.7	47.7	45.8	44.1	42.5	41.0	39.6	38.3
55	71.7	71.1	69.1	66.6	63.9	61.2	58.6	56.1	53.7	51.5	49.4	47.5	45.7	44.0	42.4	40.9	39.6	38.3
60	68.3	68.3	66.9	64.8	62.5	60.1	57.7	55.4	53.1	51.1	49.1	47.2	45.5	43.8	42.3	40.9	39.5	38.3
65	65.2	65.2	64.4	62.8	60.9	58.8	56.7	54.5	52.5	50.5	48.7	46.9	45.2	43.7	42.2	40.8	39.5	38.3
70	61.8	61.8	61.6	60.5	59.0	57.3	55.4	53.5	51.7	49.9	48.2	46.5	44.9	43.4	42.0	40.7	39.5	38.3
75	58.2	58.2	58.2	57.7	56.7	55.4	53.8	52.2	50.6	49.0	47.5	46.0	44.5	43.2	41.8	40.6	39.4	38.3
80	54.4	54.4	54.4	54.4	53.9	53.0	51.9	50.6	49.3	47.9	46.6	45.3	44.0	42.8	41.6	40.4	39.3	38.3
85	50.5	50.5	50.5	50.5	50.4	49.9	49.3	48.4	47.5	46.4	45.4	44.3	43.3	42.2	41.2	40.2	39.2	38.3
90	46.3	46.3	46.3	46.3	46.3	46.2	45.9	45.4	44.9	44.3	43.6	42.9	42.1	41.3	40.6	39.8	39.0	38.3
95	41.8	41.8	41.8	41.8	41.8	41.8	41.8	41.7	41.5	41.3	41.0	40.7	40.3	39.9	39.5	39.1	38.7	38.3
98	39.6	39.6	39.6	39.6	39.6	39.6	39.5	39.5	39.4	39.3	39.2	39.1	39.0	38.9	38.7	38.6	38.4	38.3



**Mean Annual Mass Removal Efficiencies (%) for 0.50-inches of Retention for Zone 3**

NDCIA	Percent DCIA																		
	CN	0-15	20	25	30	35	40	45	50	55	60	65	70	75	80	85	90	95	100
30	87.6	84.8	81.5	77.8	74.3	70.9	67.8	64.9	62.1	59.6	57.2	55.0	52.9	51.0	49.2	47.6	46.0	44.5	
35	85.6	83.4	80.4	77.0	73.6	70.4	67.4	64.5	61.9	59.4	57.0	54.9	52.8	51.0	49.2	47.5	46.0	44.5	
40	83.4	81.7	79.1	76.0	72.9	69.8	66.9	64.2	61.6	59.1	56.9	54.7	52.7	50.9	49.1	47.5	46.0	44.5	
45	80.9	79.7	77.6	74.9	72.0	69.1	66.4	63.7	61.2	58.9	56.6	54.6	52.6	50.8	49.1	47.5	45.9	44.5	
50	78.1	77.6	75.9	73.5	70.9	68.3	65.7	63.2	60.8	58.5	56.4	54.4	52.5	50.7	49.0	47.4	45.9	44.5	
55	75.1	75.1	73.9	71.9	69.6	67.3	64.9	62.6	60.3	58.1	56.1	54.1	52.3	50.6	48.9	47.4	45.9	44.5	
60	72.4	72.4	71.6	70.1	68.2	66.1	64.0	61.8	59.7	57.7	55.7	53.8	52.1	50.4	48.8	47.3	45.9	44.5	
65	69.3	69.3	69.1	68.0	66.5	64.7	62.8	60.9	59.0	57.1	55.2	53.5	51.8	50.2	48.7	47.2	45.8	44.5	
70	66.2	66.2	66.2	65.6	64.5	63.0	61.5	59.8	58.1	56.3	54.6	53.0	51.4	49.9	48.5	47.1	45.8	44.5	
75	62.9	62.9	62.9	62.7	62.1	61.0	59.8	58.4	56.9	55.4	53.9	52.4	51.0	49.6	48.3	47.0	45.7	44.5	
80	59.3	59.3	59.3	59.3	59.1	58.5	57.6	56.6	55.4	54.2	52.9	51.6	50.4	49.2	47.9	46.8	45.6	44.5	
85	55.8	55.6	55.6	55.6	55.6	55.3	54.9	54.2	53.4	52.6	51.8	50.6	49.6	48.5	47.5	46.5	45.5	44.5	
90	51.7	51.7	51.7	51.7	51.7	51.7	51.5	51.2	50.8	50.3	49.7	49.0	48.3	47.6	46.8	46.1	45.3	44.5	
95	47.6	47.6	47.6	47.6	47.6	47.6	47.6	47.5	47.4	47.2	47.0	46.7	46.4	46.1	45.7	45.3	44.9	44.5	
98	45.6	45.6	45.6	45.6	45.6	45.6	45.5	45.5	45.5	45.4	45.3	45.3	45.2	45.0	44.9	44.8	44.7	44.5	

**Mean Annual Mass Removal Efficiencies (%) for 0.60-inches of Retention for Zone 3**

NDCIA	Percent DCIA																		
	CN	0-15	20	25	30	35	40	45	50	55	60	65	70	75	80	85	90	95	100
30	89.6	87.5	84.9	82.0	78.9	75.8	72.9	70.1	67.5	65.1	62.8	60.6	58.5	56.6	54.7	53.0	51.4	49.9	
35	87.8	86.1	83.8	81.1	78.2	75.3	72.5	69.8	67.3	64.9	62.6	60.4	58.4	56.5	54.7	53.0	51.4	49.9	
40	85.8	84.4	82.5	80.1	77.4	74.7	72.0	69.4	66.9	64.6	62.4	60.3	58.3	56.4	54.6	53.0	51.4	49.9	
45	83.3	82.5	81.0	78.9	76.5	73.9	71.4	68.9	66.6	64.3	62.2	60.1	58.2	56.3	54.6	52.9	51.4	49.9	
50	80.6	80.3	79.3	77.5	75.3	73.0	70.7	68.4	66.1	63.9	61.9	59.9	58.0	56.2	54.5	52.9	51.4	49.9	
55	77.9	77.9	77.3	75.9	74.0	72.0	69.8	67.7	65.6	63.5	61.5	59.6	57.8	56.1	54.4	52.8	51.3	49.9	
60	75.3	75.3	75.1	74.1	72.5	70.7	68.8	66.9	64.9	63.0	61.1	59.3	57.6	55.9	54.3	52.8	51.3	49.9	
65	72.5	72.5	72.5	71.9	70.8	69.3	67.6	65.9	64.1	62.3	60.6	58.9	57.3	55.6	54.1	52.7	51.3	49.9	
70	69.6	69.6	69.6	69.5	68.7	67.5	66.2	64.7	63.1	61.6	60.0	58.4	56.9	55.4	53.9	52.5	51.2	49.9	
75	66.6	66.6	66.6	66.6	66.2	65.5	64.4	63.2	61.9	60.6	59.2	57.8	56.4	55.0	53.7	52.4	51.1	49.9	
80	63.4	63.4	63.4	63.4	63.3	62.9	62.2	61.4	60.4	59.3	58.1	56.9	55.7	54.5	53.3	52.2	51.0	49.9	
85	59.9	59.9	59.9	59.9	59.9	59.8	59.4	58.9	58.3	57.6	56.7	55.8	54.8	53.8	52.9	51.9	50.9	49.9	
90	56.2	56.2	56.2	56.2	56.2	56.2	56.2	56.0	55.7	55.2	54.7	54.1	53.5	52.8	52.1	51.4	50.7	49.9	
95	52.5	52.5	52.5	52.5	52.5	52.5	52.5	52.5	52.4	52.3	52.1	51.9	51.6	51.3	51.0	50.7	50.3	49.9	
98	50.7	50.7	50.7	50.7	50.7	50.7	50.7	50.7	50.7	50.6	50.6	50.5	50.4	50.4	50.3	50.2	50.0	49.9	



**Mean Annual Mass Removal Efficiencies (%) for 0.70-inches of Retention for Zone 3**

NDCIA CN	Percent DCIA																	
	0-15	20	25	30	35	40	45	50	55	60	65	70	75	80	85	90	95	100
30	91.0	89.5	87.4	85.0	82.4	79.7	77.0	74.4	71.9	69.6	67.3	65.2	63.2	61.3	59.5	57.8	56.1	54.6
35	89.2	88.1	86.2	84.1	81.7	79.1	76.5	74.0	71.6	69.3	67.2	65.1	63.1	61.2	59.4	57.7	56.1	54.6
40	87.3	86.5	84.9	83.0	80.6	78.4	76.0	73.6	71.3	69.1	67.0	64.9	63.0	61.1	59.4	57.7	56.1	54.6
45	85.0	84.6	83.4	81.9	79.9	77.7	75.4	73.1	70.9	68.8	66.7	64.7	62.8	61.0	59.3	57.7	56.1	54.6
50	82.5	82.5	81.7	80.5	78.7	76.7	74.6	72.5	70.4	68.4	66.4	64.5	62.7	60.9	59.2	57.6	56.1	54.6
55	80.2	80.2	79.8	78.9	77.4	75.6	73.7	71.8	69.8	67.9	66.0	64.2	62.4	60.7	59.1	57.5	56.0	54.6
60	77.7	77.7	77.7	77.1	75.9	74.4	72.7	70.9	69.1	67.4	65.6	63.9	62.2	60.5	59.0	57.5	56.0	54.6
65	75.2	75.2	75.2	74.9	74.1	72.9	71.5	69.9	68.3	66.7	65.0	63.4	61.9	60.3	58.8	57.3	55.9	54.6
70	72.5	72.5	72.5	72.5	72.0	71.1	70.0	68.7	67.3	65.9	64.4	62.9	61.5	60.0	58.6	57.2	55.9	54.6
75	69.7	69.7	69.7	69.7	69.6	69.0	68.2	67.2	66.0	64.8	63.5	62.2	60.9	59.6	58.3	57.1	55.8	54.6
80	66.7	66.7	66.7	66.7	66.7	66.5	66.0	65.3	64.4	63.5	62.4	61.4	60.3	59.1	58.0	56.8	55.7	54.6
85	63.5	63.5	63.5	63.5	63.5	63.5	63.3	62.9	62.3	61.7	61.0	60.2	59.3	58.4	57.5	56.5	55.5	54.6
90	60.1	60.1	60.1	60.1	60.1	60.1	60.1	60.0	59.8	59.4	59.0	58.5	58.0	57.4	56.7	56.0	55.3	54.6
95	56.8	56.8	56.8	56.8	56.8	56.8	56.8	56.8	56.7	56.7	56.5	56.4	56.1	55.9	55.6	55.3	54.9	54.6
98	55.2	55.2	55.2	55.2	55.2	55.2	55.2	55.2	55.2	55.2	55.1	55.1	55.0	54.9	54.8	54.7	54.6	54.6

**Mean Annual Mass Removal Efficiencies (%) for 0.80-inches of Retention for Zone 3**

NDCIA CN	Percent DCIA																	
	0-15	20	25	30	35	40	45	50	55	60	65	70	75	80	85	90	95	100
30	92.2	90.9	89.2	87.2	85.0	82.7	80.2	77.8	75.5	73.3	71.2	69.1	67.2	65.3	63.6	61.9	60.3	58.7
35	90.4	89.6	88.1	86.3	84.3	82.1	79.8	77.5	75.2	73.1	71.0	69.0	67.1	65.3	63.5	61.8	60.2	58.7
40	88.5	88.1	86.9	85.2	83.4	81.4	79.2	77.0	74.9	72.8	70.8	68.8	67.0	65.2	63.4	61.8	60.2	58.7
45	86.4	86.3	85.4	84.0	82.5	80.6	78.6	76.5	74.5	72.4	70.5	68.6	66.8	65.0	63.4	61.8	60.2	58.7
50	84.3	84.3	83.7	82.7	81.3	79.7	77.8	75.9	73.9	72.0	70.2	68.4	66.6	64.9	63.3	61.7	60.2	58.7
55	82.1	82.1	81.9	81.1	80.0	78.6	76.9	75.1	73.3	71.6	69.8	68.1	66.4	64.7	63.2	61.6	60.1	58.7
60	79.7	79.7	79.7	79.4	78.5	77.3	75.9	74.3	72.6	71.0	69.3	67.7	66.1	64.5	63.0	61.5	60.1	58.7
65	77.4	77.4	77.4	77.3	76.8	75.8	74.6	73.2	71.8	70.3	68.8	67.3	65.8	64.3	62.8	61.4	60.0	58.7
70	75.0	75.0	75.0	75.0	74.7	74.1	73.1	72.0	70.8	69.4	68.1	66.7	65.3	64.0	62.6	61.3	60.0	58.7
75	72.3	72.3	72.3	72.3	72.3	72.0	71.3	70.5	69.5	68.4	67.2	66.0	64.8	63.6	62.3	61.1	59.9	58.7
80	69.6	69.6	69.6	69.6	69.6	69.5	69.1	68.5	67.8	67.0	66.1	65.1	64.1	63.0	62.0	60.9	59.8	58.7
85	66.7	66.7	66.7	66.7	66.7	66.7	66.5	66.2	65.8	65.2	64.6	63.9	63.1	62.3	61.4	60.5	59.6	58.7
90	63.5	63.5	63.5	63.5	63.5	63.5	63.5	63.5	63.3	63.0	62.7	62.2	61.8	61.2	60.7	60.0	59.4	58.7
95	60.4	60.4	60.4	60.4	60.4	60.4	60.4	60.4	60.4	60.4	60.3	60.2	60.0	59.8	59.6	59.3	59.0	58.7
98	59.1	59.1	59.1	59.1	59.1	59.1	59.1	59.1	59.1	59.1	59.1	59.1	59.0	58.9	58.9	58.8	58.7	58.7



Mean Annual Mass Removal Efficiencies (%) for 0.90-inches of Retention for Zone 3

NDCIA CN	Percent DCIA																	
	0-15	20	25	30	35	40	45	50	55	60	65	70	75	80	85	90	95	100
30	93.1	92.0	90.6	88.9	87.0	85.0	82.9	80.7	78.5	76.4	74.4	72.5	70.6	68.8	67.1	65.4	63.8	62.3
35	91.4	90.7	89.6	88.0	86.3	84.4	82.4	80.3	78.2	76.2	74.2	72.3	70.5	68.7	67.0	65.4	63.8	62.3
40	89.5	89.3	88.4	87.0	85.4	83.7	81.9	79.9	77.9	75.9	74.0	72.1	70.4	68.6	67.0	65.3	63.8	62.3
45	87.6	87.6	87.0	85.8	84.5	82.9	81.2	79.4	77.4	75.6	73.7	71.9	70.2	68.5	66.9	65.3	63.8	62.3
50	85.7	85.7	85.4	84.5	83.4	82.0	80.4	78.7	76.9	75.1	73.4	71.7	70.0	68.4	66.8	65.2	63.8	62.3
55	83.6	83.6	83.5	83.0	82.1	80.9	79.5	78.0	76.3	74.6	73.0	71.4	69.7	68.2	66.6	65.2	63.7	62.3
60	81.5	81.5	81.5	81.2	80.6	79.7	78.5	77.1	75.6	74.1	72.5	71.0	69.5	68.0	66.5	65.1	63.7	62.3
65	79.2	79.2	79.2	79.2	78.9	78.2	77.2	76.0	74.7	73.3	71.9	70.5	69.1	67.7	66.3	65.0	63.6	62.3
70	77.0	77.0	77.0	77.0	76.9	76.5	75.7	74.8	73.7	72.5	71.2	70.0	68.7	67.4	66.1	64.8	63.6	62.3
75	74.6	74.6	74.6	74.6	74.6	74.4	73.9	73.2	72.4	71.4	70.3	69.2	68.1	67.0	65.8	64.6	63.5	62.3
80	72.1	72.1	72.1	72.1	72.1	72.1	71.8	71.4	70.7	70.0	69.2	68.3	67.4	66.4	65.4	64.4	63.4	62.3
85	69.4	69.4	69.4	69.4	69.4	69.4	69.3	69.1	68.7	68.3	67.7	67.1	66.4	65.6	64.8	64.0	63.2	62.3
90	66.5	66.5	66.5	66.5	66.5	66.5	66.5	66.5	66.4	66.2	65.9	65.5	65.1	64.6	64.1	63.5	62.9	62.3
95	63.7	63.7	63.7	63.7	63.7	63.7	63.7	63.7	63.7	63.7	63.7	63.6	63.4	63.3	63.1	62.9	62.6	62.3
98	62.6	62.6	62.6	62.6	62.6	62.6	62.6	62.6	62.6	62.6	62.6	62.6	62.6	62.5	62.5	62.4	62.4	62.3

Mean Annual Mass Removal Efficiencies (%) for 1.00-inches of Retention for Zone 3

NDCIA CN	Percent DCIA																	
	0-15	20	25	30	35	40	45	50	55	60	65	70	75	80	85	90	95	100
30	94.0	92.9	91.7	90.3	88.6	86.8	85.0	83.1	81.1	79.1	77.2	75.3	73.5	71.8	70.1	68.5	67.0	65.5
35	92.2	91.6	90.7	89.5	87.9	86.3	84.5	82.7	80.8	78.9	77.0	75.2	73.4	71.7	70.1	68.5	67.0	65.5
40	90.4	90.3	89.6	88.5	87.1	85.6	83.9	82.2	80.4	78.6	76.8	75.0	73.3	71.6	70.0	68.5	66.9	65.5
45	88.7	88.7	88.2	87.3	86.1	84.8	83.3	81.7	80.0	78.2	76.5	74.8	73.1	71.5	69.9	68.4	66.9	65.5
50	86.9	86.9	86.7	86.0	85.0	83.9	82.5	81.0	79.4	77.8	76.1	74.5	72.9	71.3	69.8	68.3	66.9	65.5
55	85.0	85.0	85.0	84.5	83.7	82.8	81.6	80.3	78.8	77.3	75.7	74.2	72.7	71.2	69.7	68.3	66.9	65.5
60	83.0	83.0	83.0	82.8	82.3	81.6	80.6	79.4	78.1	76.7	75.2	73.8	72.4	70.9	69.5	68.2	66.8	65.5
65	80.9	80.9	80.9	80.9	80.6	80.1	79.4	78.4	77.2	75.9	74.6	73.3	72.0	70.7	69.4	68.0	66.8	65.5
70	78.8	78.8	78.8	78.8	78.7	78.5	77.9	77.1	76.2	75.1	73.9	72.8	71.5	70.3	69.1	67.9	66.7	65.5
75	76.6	76.6	76.6	76.6	76.6	76.5	76.1	75.6	74.9	74.0	73.0	72.0	71.0	69.9	68.8	67.7	66.6	65.5
80	74.3	74.3	74.3	74.3	74.3	74.3	74.1	73.8	73.3	72.6	71.9	71.1	70.2	69.3	68.4	67.5	66.5	65.5
85	71.8	71.8	71.8	71.8	71.8	71.8	71.8	71.6	71.3	70.9	70.5	69.9	69.3	68.6	67.9	67.1	66.3	65.5
90	69.2	69.2	69.2	69.2	69.2	69.2	69.2	69.2	69.1	68.9	68.7	68.4	68.0	67.6	67.1	66.6	66.1	65.5
95	66.6	66.6	66.6	66.6	66.6	66.6	66.6	66.6	66.6	66.6	66.6	66.5	66.4	66.3	66.1	66.0	65.7	65.5
98	65.7	65.7	65.7	65.7	65.7	65.7	65.7	65.7	65.7	65.7	65.7	65.7	65.7	65.6	65.6	65.5	65.5	65.5



**Mean Annual Mass Removal Efficiencies (%) for 1.25-inches of Retention for Zone 3**

NDCIA CN	Percent DCIA																		
	0-15	20	25	30	35	40	45	50	55	60	65	70	75	80	85	90	95	100	
30	95.2	94.8	93.7	92.7	91.5	90.2	88.7	87.3	85.7	84.2	82.6	81.0	79.4	77.8	76.3	74.8	73.4	72.0	
35	93.9	93.5	92.7	91.9	90.8	89.6	88.2	86.9	85.4	83.9	82.4	80.8	79.3	77.7	76.2	74.8	73.4	72.0	
40	92.2	92.2	91.7	91.0	90.1	89.0	87.7	86.4	85.0	83.6	82.1	80.6	79.1	77.6	76.2	74.7	73.3	72.0	
45	90.7	90.7	90.5	90.0	89.2	88.2	87.0	85.9	84.6	83.2	81.8	80.4	78.9	77.5	76.1	74.7	73.3	72.0	
50	89.2	89.2	89.2	88.9	88.2	87.3	86.3	85.2	84.1	82.8	81.5	80.1	78.7	77.3	75.9	74.6	73.3	72.0	
55	87.6	87.6	87.6	87.5	87.0	86.3	85.4	84.5	83.5	82.3	81.1	79.8	78.4	77.1	75.8	74.5	73.2	72.0	
60	86.0	86.0	86.0	86.0	85.7	85.1	84.4	83.7	82.8	81.7	80.6	79.4	78.1	76.9	75.6	74.4	73.2	72.0	
65	84.2	84.2	84.2	84.2	84.1	83.8	83.3	82.7	81.9	81.0	80.0	78.9	77.8	76.6	75.4	74.3	73.1	72.0	
70	82.4	82.4	82.4	82.4	82.4	82.3	82.0	81.5	80.9	80.1	79.3	78.3	77.3	76.3	75.2	74.1	73.1	72.0	
75	80.6	80.6	80.6	80.6	80.6	80.6	80.4	80.1	79.7	79.1	78.4	77.6	76.7	75.8	74.9	73.9	73.0	72.0	
80	78.7	78.7	78.7	78.7	78.7	78.7	78.7	78.5	78.2	77.8	77.3	76.7	76.0	75.2	74.5	73.7	72.8	72.0	
85	76.7	76.7	76.7	76.7	76.7	76.7	76.7	76.7	76.6	76.3	76.0	75.5	75.1	74.5	73.9	73.3	72.7	72.0	
90	74.6	74.6	74.6	74.6	74.6	74.6	74.6	74.6	74.6	74.6	74.4	74.2	73.9	73.6	73.3	72.9	72.4	72.0	
95	72.6	72.6	72.6	72.6	72.6	72.6	72.6	72.6	72.6	72.6	72.6	72.6	72.6	72.6	72.5	72.4	72.3	72.2	72.0
98	72.0	72.0	72.0	72.0	72.0	72.0	72.0	72.0	72.0	72.0	72.0	72.0	72.0	72.0	72.0	72.0	72.0	72.0	72.0

**Mean Annual Mass Removal Efficiencies (%) for 1.50-inches of Retention for Zone 3**

NDCIA CN	Percent DCIA																		
	0-15	20	25	30	35	40	45	50	55	60	65	70	75	80	85	90	95	100	
30	95.9	95.9	95.3	94.3	93.3	92.3	91.2	90.1	88.8	87.6	86.3	84.9	83.6	82.3	80.9	79.6	78.2	77.0	
35	94.9	94.9	94.3	93.5	92.7	91.8	90.8	89.7	88.5	87.3	86.0	84.6	83.5	82.2	80.8	79.5	78.2	77.0	
40	93.6	93.6	93.3	92.7	92.0	91.2	90.3	89.2	88.1	87.0	85.8	84.6	83.3	82.0	80.8	79.5	78.2	77.0	
45	92.2	92.2	92.1	91.8	91.2	90.5	89.7	88.7	87.7	86.6	85.5	84.3	83.1	81.9	80.7	79.4	78.2	77.0	
50	90.9	90.9	90.9	90.7	90.4	89.7	89.0	88.1	87.1	86.2	85.1	84.0	82.9	81.7	80.5	79.3	78.1	77.0	
55	89.6	89.6	89.6	89.6	89.3	88.8	88.2	87.4	86.6	85.7	84.7	83.7	82.7	81.5	80.4	79.2	78.1	77.0	
60	88.2	88.2	88.2	88.2	88.1	87.7	87.2	86.6	85.9	85.1	84.3	83.3	82.4	81.3	80.2	79.1	78.0	77.0	
65	86.7	86.7	86.7	86.7	86.7	86.5	86.1	85.6	85.1	84.4	83.7	82.9	82.0	81.0	80.0	79.0	78.0	77.0	
70	85.2	85.2	85.2	85.2	85.2	85.1	84.9	84.6	84.1	83.6	83.0	82.3	81.5	80.7	79.8	78.8	77.9	77.0	
75	83.6	83.6	83.6	83.6	83.6	83.6	83.5	83.3	83.1	82.7	82.2	81.6	81.0	80.3	79.5	78.6	77.8	77.0	
80	82.0	82.0	82.0	82.0	82.0	82.0	82.0	82.0	81.8	81.6	81.2	80.8	80.3	79.7	79.1	78.4	77.7	77.0	
85	80.4	80.4	80.4	80.4	80.4	80.4	80.4	80.4	80.4	80.3	80.1	79.8	79.5	79.0	78.6	78.1	77.5	77.0	
90	78.8	78.8	78.8	78.8	78.8	78.8	78.8	78.8	78.8	78.8	78.8	78.6	78.5	78.2	78.0	77.7	77.3	77.0	
95	77.3	77.3	77.3	77.3	77.3	77.3	77.3	77.3	77.3	77.3	77.3	77.3	77.3	77.3	77.2	77.2	77.1	77.0	
98	77.0	77.0	77.0	77.0	77.0	77.0	77.0	77.0	77.0	77.0	77.0	77.0	77.0	77.0	77.0	77.0	77.0	77.0	77.0



**Mean Annual Mass Removal Efficiencies (%) for 1.75-inches of Retention for Zone 3**

NDCIA CN	Percent DCIA																	
	0-15	20	25	30	35	40	45	50	55	60	65	70	75	80	85	90	95	100
30	96.6	96.6	96.3	95.6	94.7	93.8	92.9	92.0	91.0	89.9	88.8	87.8	86.6	85.5	84.3	83.2	82.0	80.8
35	95.7	95.7	95.5	94.8	94.1	93.3	92.5	91.6	90.7	89.7	88.6	87.6	86.5	85.4	84.3	83.1	82.0	80.8
40	94.7	94.7	94.5	94.0	93.4	92.7	92.0	91.2	90.4	89.4	88.4	87.4	86.3	85.3	84.2	83.1	82.0	80.8
45	93.5	93.5	93.4	93.1	92.6	92.1	91.5	90.8	89.9	89.0	88.1	87.1	86.2	85.1	84.1	83.0	81.9	80.8
50	92.2	92.2	92.2	92.1	91.8	91.4	90.9	90.2	89.5	88.6	87.7	86.9	85.9	85.0	84.0	82.9	81.9	80.8
55	91.1	91.1	91.1	91.1	90.9	90.6	90.2	89.6	88.9	88.1	87.4	86.6	85.7	84.8	83.8	82.9	81.9	80.8
60	89.9	89.9	89.9	89.9	89.9	89.7	89.3	88.8	88.2	87.6	86.9	86.2	85.4	84.6	83.7	82.8	81.8	80.8
65	88.7	88.7	88.7	88.7	88.7	88.6	88.3	87.9	87.5	86.9	86.4	85.7	85.0	84.3	83.5	82.6	81.8	80.8
70	87.4	87.4	87.4	87.4	87.4	87.4	87.2	87.0	86.6	86.2	85.7	85.2	84.6	84.0	83.2	82.5	81.7	80.8
75	86.0	86.0	86.0	86.0	86.0	86.0	86.0	85.8	85.6	85.3	85.0	84.6	84.1	83.5	82.9	82.3	81.6	80.8
80	84.6	84.6	84.6	84.6	84.6	84.6	84.6	84.6	84.5	84.4	84.1	83.8	83.5	83.1	82.6	82.0	81.5	80.8
85	83.3	83.3	83.3	83.3	83.3	83.3	83.3	83.3	83.3	83.3	83.2	83.0	82.8	82.5	82.1	81.7	81.3	80.8
90	82.1	82.1	82.1	82.1	82.1	82.1	82.1	82.1	82.1	82.1	82.1	82.0	81.9	81.8	81.6	81.4	81.1	80.8
95	81.0	81.0	81.0	81.0	81.0	81.0	81.0	81.0	81.0	81.0	81.0	81.0	81.0	81.0	81.0	81.0	80.9	80.8
98	80.8	80.8	80.8	80.8	80.8	80.8	80.8	80.8	80.8	80.8	80.8	80.8	80.8	80.8	80.8	80.8	80.8	80.8

**Mean Annual Mass Removal Efficiencies (%) for 2.00-inches of Retention for Zone 3**

NDCIA CN	Percent DCIA																	
	0-15	20	25	30	35	40	45	50	55	60	65	70	75	80	85	90	95	100
30	97.0	97.0	97.0	96.6	95.8	95.0	94.2	93.4	92.6	91.7	90.8	89.8	88.9	87.9	86.9	85.9	84.9	83.9
35	96.3	96.3	96.3	95.9	95.2	94.5	93.8	93.1	92.3	91.5	90.6	89.7	88.7	87.8	86.8	85.9	84.9	83.9
40	95.4	95.4	95.4	95.1	94.5	93.9	93.3	92.7	92.0	91.2	90.4	89.5	88.6	87.7	86.8	85.8	84.8	83.9
45	94.5	94.5	94.4	94.2	93.8	93.3	92.8	92.3	91.6	90.9	90.1	89.2	88.4	87.6	86.7	85.8	84.8	83.9
50	93.3	93.3	93.3	93.3	93.0	92.7	92.3	91.8	91.2	90.5	89.8	89.0	88.2	87.4	86.6	85.7	84.8	83.9
55	92.2	92.2	92.2	92.2	92.2	91.9	91.6	91.2	90.7	90.1	89.4	88.7	87.9	87.2	86.4	85.6	84.7	83.9
60	91.2	91.2	91.2	91.2	91.2	91.1	90.9	90.5	90.1	89.6	88.9	88.3	87.7	87.0	86.3	85.5	84.7	83.9
65	90.2	90.2	90.2	90.2	90.2	90.2	90.0	89.7	89.4	88.9	88.4	87.9	87.3	86.7	86.1	85.4	84.6	83.9
70	89.1	89.1	89.1	89.1	89.1	89.1	89.1	88.8	88.6	88.2	87.8	87.4	86.9	86.4	85.8	85.2	84.6	83.9
75	88.0	88.0	88.0	88.0	88.0	88.0	87.9	87.9	87.7	87.4	87.1	86.8	86.4	86.0	85.6	85.0	84.5	83.9
80	86.8	86.8	86.8	86.8	86.8	86.8	86.8	86.8	86.7	86.6	86.4	86.2	85.9	85.6	85.2	84.8	84.4	83.9
85	85.6	85.6	85.6	85.6	85.6	85.6	85.6	85.6	85.6	85.6	85.5	85.4	85.3	85.1	84.9	84.6	84.2	83.9
90	84.6	84.6	84.6	84.6	84.6	84.6	84.6	84.6	84.6	84.6	84.6	84.6	84.6	84.5	84.4	84.3	84.1	83.9
95	83.9	83.9	83.9	83.9	83.9	83.9	83.9	83.9	83.9	83.9	83.9	83.9	83.9	83.9	83.9	83.9	83.9	83.9
98	83.9	83.9	83.9	83.9	83.9	83.9	83.9	83.9	83.9	83.9	83.9	83.9	83.9	83.9	83.9	83.9	83.9	83.9



**Mean Annual Mass Removal Efficiencies (%) for 2.25-inches of Retention for Zone 3**

NDCIA CN	Percent DCIA																	
	0-15	20	25	30	35	40	45	50	55	60	65	70	75	80	85	90	95	100
30	97.4	97.4	97.4	97.2	96.7	96.0	95.2	94.5	93.8	93.0	92.3	91.5	90.6	89.8	88.9	88.0	87.1	86.2
35	96.8	96.8	96.8	96.6	96.1	95.5	94.8	94.2	93.5	92.8	92.1	91.3	90.5	89.7	88.8	88.0	87.1	86.2
40	96.1	96.1	96.1	95.9	95.5	95.0	94.4	93.8	93.2	92.5	91.9	91.1	90.4	89.5	88.7	87.9	87.1	86.2
45	95.3	95.3	95.3	95.1	94.8	94.4	93.9	93.4	92.8	92.2	91.6	90.9	90.2	89.4	88.6	87.9	87.1	86.2
50	94.3	94.3	94.3	94.2	94.0	93.7	93.3	92.9	92.5	91.9	91.3	90.7	90.0	89.3	88.5	87.8	87.0	86.2
55	93.3	93.3	93.3	93.3	93.2	93.0	92.7	92.4	92.0	91.5	91.0	90.4	89.7	89.1	88.4	87.7	87.0	86.2
60	92.3	92.3	92.3	92.3	92.3	92.2	92.0	91.8	91.5	91.0	90.6	90.1	89.5	88.9	88.2	87.6	86.9	86.2
65	91.4	91.4	91.4	91.4	91.4	91.4	91.3	91.1	90.9	90.5	90.1	89.7	89.1	88.6	88.1	87.5	86.9	86.2
70	90.5	90.5	90.5	90.5	90.5	90.5	90.5	90.4	90.2	89.9	89.6	89.2	88.8	88.3	87.9	87.4	86.8	86.2
75	89.6	89.6	89.6	89.6	89.6	89.6	89.6	89.5	89.4	89.2	89.0	88.7	88.3	88.0	87.6	87.2	86.7	86.2
80	88.5	88.5	88.5	88.5	88.5	88.5	88.5	88.5	88.5	88.4	88.3	88.1	87.8	87.6	87.3	87.0	86.6	86.2
85	87.5	87.5	87.5	87.5	87.5	87.5	87.5	87.5	87.5	87.5	87.5	87.4	87.3	87.1	87.0	86.8	86.5	86.2
90	86.7	86.7	86.7	86.7	86.7	86.7	86.7	86.7	86.7	86.7	86.7	86.7	86.7	86.7	86.6	86.5	86.4	86.2
95	86.3	86.3	86.3	86.3	86.3	86.3	86.3	86.3	86.3	86.3	86.3	86.3	86.3	86.3	86.3	86.3	86.3	86.2
98	86.2	86.2	86.2	86.2	86.2	86.2	86.2	86.2	86.2	86.2	86.2	86.2	86.2	86.2	86.2	86.2	86.2	86.2

**Mean Annual Mass Removal Efficiencies (%) for 2.50-inches of Retention for Zone 3**

NDCIA CN	Percent DCIA																	
	0-15	20	25	30	35	40	45	50	55	60	65	70	75	80	85	90	95	100
30	97.6	97.6	97.6	97.6	97.3	96.8	96.1	95.4	94.7	94.1	93.4	92.7	92.0	91.3	90.5	89.7	88.9	88.1
35	97.1	97.1	97.1	97.1	96.8	96.3	95.7	95.1	94.5	93.9	93.2	92.6	91.9	91.2	90.4	89.7	88.9	88.1
40	96.5	96.5	96.5	96.5	96.3	95.8	95.3	94.7	94.2	93.6	93.0	92.4	91.7	91.1	90.3	89.6	88.9	88.1
45	95.9	95.9	95.9	95.9	95.6	95.2	94.8	94.3	93.8	93.3	92.8	92.2	91.6	90.9	90.2	89.5	88.8	88.1
50	95.1	95.1	95.1	95.1	94.9	94.6	94.3	93.8	93.4	93.0	92.5	92.0	91.4	90.8	90.1	89.5	88.8	88.1
55	94.2	94.2	94.2	94.2	94.1	93.9	93.7	93.3	93.0	92.6	92.2	91.7	91.2	90.6	90.0	89.4	88.8	88.1
60	93.3	93.3	93.3	93.3	93.3	93.2	93.0	92.8	92.5	92.2	91.8	91.4	90.9	90.4	89.9	89.3	88.7	88.1
65	92.4	92.4	92.4	92.4	92.4	92.4	92.3	92.2	92.0	91.7	91.4	91.0	90.7	90.2	89.7	89.2	88.7	88.1
70	91.6	91.6	91.6	91.6	91.6	91.6	91.6	91.5	91.4	91.2	90.9	90.6	90.3	89.9	89.5	89.0	88.6	88.1
75	90.8	90.8	90.8	90.8	90.8	90.8	90.8	90.8	90.7	90.6	90.4	90.2	89.9	89.6	89.2	88.9	88.5	88.1
80	90.0	90.0	90.0	90.0	90.0	90.0	90.0	90.0	90.0	89.9	89.8	89.7	89.5	89.2	89.0	88.7	88.4	88.1
85	89.1	89.1	89.1	89.1	89.1	89.1	89.1	89.1	89.1	89.1	89.1	89.1	89.0	88.8	88.7	88.5	88.3	88.1
90	88.4	88.4	88.4	88.4	88.4	88.4	88.4	88.4	88.4	88.4	88.4	88.4	88.4	88.4	88.3	88.3	88.2	88.1
95	88.1	88.1	88.1	88.1	88.1	88.1	88.1	88.1	88.1	88.1	88.1	88.1	88.1	88.1	88.1	88.1	88.1	88.1
98	88.1	88.1	88.1	88.1	88.1	88.1	88.1	88.1	88.1	88.1	88.1	88.1	88.1	88.1	88.1	88.1	88.1	88.1



**Mean Annual Mass Removal Efficiencies (%) for 2.75-inches of Retention for Zone 3**

NDCIA	Percent DCIA																	
	CN	0-15	20	25	30	35	40	45	50	55	60	65	70	75	80	85	90	95
30	97.9	97.9	97.9	97.9	97.7	97.4	96.8	96.2	95.6	94.9	94.4	93.7	93.1	92.4	91.8	91.1	90.4	89.6
35	97.4	97.4	97.4	97.4	97.3	97.0	96.5	95.9	95.3	94.7	94.2	93.6	93.0	92.4	91.7	91.0	90.3	89.6
40	97.0	97.0	97.0	97.0	96.8	96.5	96.0	95.5	95.0	94.5	94.0	93.4	92.8	92.2	91.6	91.0	90.3	89.6
45	96.4	96.4	96.4	96.4	96.3	96.0	95.6	95.1	94.7	94.2	93.7	93.2	92.7	92.1	91.6	90.9	90.3	89.6
50	95.8	95.8	95.8	95.8	95.6	95.4	95.0	94.7	94.3	93.9	93.5	93.0	92.5	92.0	91.5	90.9	90.3	89.6
55	95.0	95.0	95.0	95.0	94.9	94.7	94.5	94.2	93.9	93.5	93.2	92.8	92.3	91.8	91.3	90.8	90.2	89.6
60	94.2	94.2	94.2	94.2	94.2	94.0	93.9	93.7	93.4	93.1	92.9	92.5	92.1	91.7	91.2	90.7	90.2	89.6
65	93.3	93.3	93.3	93.3	93.3	93.3	93.2	93.1	92.9	92.7	92.5	92.2	91.8	91.4	91.1	90.6	90.1	89.6
70	92.5	92.5	92.5	92.5	92.5	92.5	92.5	92.4	92.2	92.0	91.8	91.5	91.2	90.9	90.5	90.1	89.6	
75	91.8	91.8	91.8	91.8	91.8	91.8	91.8	91.8	91.7	91.6	91.4	91.2	90.9	90.7	90.3	90.0	89.6	
80	91.1	91.1	91.1	91.1	91.1	91.1	91.1	91.1	91.1	91.0	90.9	90.8	90.6	90.4	90.2	89.9	89.6	
85	90.4	90.4	90.4	90.4	90.4	90.4	90.4	90.4	90.4	90.4	90.4	90.4	90.3	90.1	90.0	89.8	89.6	
90	89.9	89.9	89.9	89.9	89.9	89.9	89.9	89.9	89.9	89.9	89.9	89.9	89.9	89.8	89.8	89.7	89.6	
95	89.6	89.6	89.6	89.6	89.6	89.6	89.6	89.6	89.6	89.6	89.6	89.6	89.6	89.6	89.6	89.6	89.6	
98	89.6	89.6	89.6	89.6	89.6	89.6	89.6	89.6	89.6	89.6	89.6	89.6	89.6	89.6	89.6	89.6	89.6	

**Mean Annual Mass Removal Efficiencies (%) for 3.00-inches of Retention for Zone 3**

NDCIA	Percent DCIA																	
	CN	0-15	20	25	30	35	40	45	50	55	60	65	70	75	80	85	90	95
30	98.0	98.0	98.0	98.0	98.0	97.8	97.4	96.9	96.3	95.7	95.1	94.6	94.0	93.4	92.8	92.2	91.6	90.9
35	97.7	97.7	97.7	97.7	97.7	97.4	97.1	96.6	96.0	95.5	94.9	94.4	93.9	93.3	92.7	92.2	91.6	90.9
40	97.2	97.2	97.2	97.2	97.2	97.1	96.7	96.2	95.7	95.2	94.7	94.3	93.7	93.2	92.7	92.1	91.5	90.9
45	96.8	96.8	96.8	96.8	96.8	96.6	96.2	95.8	95.4	95.0	94.5	94.1	93.6	93.1	92.6	92.1	91.5	90.9
50	96.3	96.3	96.3	96.3	96.2	96.0	95.8	95.4	95.1	94.7	94.3	93.9	93.4	93.0	92.5	92.0	91.5	90.9
55	95.7	95.7	95.7	95.7	95.6	95.4	95.2	94.9	94.6	94.3	94.0	93.6	93.3	92.8	92.4	91.9	91.4	90.9
60	94.9	94.9	94.9	94.9	94.9	94.8	94.6	94.4	94.2	93.9	93.7	93.4	93.0	92.7	92.3	91.9	91.4	90.9
65	94.2	94.2	94.2	94.2	94.2	94.1	94.0	93.9	93.7	93.5	93.3	93.1	92.8	92.5	92.1	91.8	91.4	90.9
70	93.4	93.4	93.4	93.4	93.4	93.4	93.4	93.3	93.2	93.1	92.9	92.8	92.5	92.2	92.0	91.6	91.3	90.9
75	92.7	92.7	92.7	92.7	92.7	92.7	92.7	92.7	92.7	92.6	92.5	92.4	92.2	92.0	91.8	91.5	91.2	90.9
80	92.1	92.1	92.1	92.1	92.1	92.1	92.1	92.1	92.1	92.1	92.1	92.0	91.8	91.7	91.6	91.4	91.2	90.9
85	91.5	91.5	91.5	91.5	91.5	91.5	91.5	91.5	91.5	91.5	91.5	91.5	91.5	91.4	91.3	91.2	91.1	90.9
90	91.1	91.1	91.1	91.1	91.1	91.1	91.1	91.1	91.1	91.1	91.1	91.1	91.1	91.1	91.1	91.0	91.0	90.9
95	90.9	90.9	90.9	90.9	90.9	90.9	90.9	90.9	90.9	90.9	90.9	90.9	90.9	90.9	90.9	90.9	90.9	90.9
98	90.9	90.9	90.9	90.9	90.9	90.9	90.9	90.9	90.9	90.9	90.9	90.9	90.9	90.9	90.9	90.9	90.9	90.9



Mean Annual Mass Removal Efficiencies (%) for 3.25-inches of Retention for Zone 3

NDCIA CN	Percent DCIA																	
	0-15	20	25	30	35	40	45	50	55	60	65	70	75	80	85	90	95	100
30	98.2	98.2	98.2	98.2	98.2	98.1	97.8	97.5	96.9	96.4	95.8	95.3	94.7	94.2	93.7	93.1	92.6	92.0
35	97.9	97.9	97.9	97.9	97.9	97.8	97.5	97.2	96.7	96.2	95.6	95.1	94.6	94.1	93.6	93.1	92.5	92.0
40	97.5	97.5	97.5	97.5	97.5	97.4	97.2	96.8	96.4	95.9	95.4	95.0	94.5	94.0	93.5	93.0	92.5	92.0
45	97.1	97.1	97.1	97.1	97.1	97.1	96.8	96.5	96.1	95.7	95.2	94.8	94.4	93.9	93.5	93.0	92.5	92.0
50	96.7	96.7	96.7	96.7	96.7	96.6	96.3	96.1	95.7	95.4	95.0	94.6	94.2	93.8	93.4	92.9	92.5	92.0
55	96.2	96.2	96.2	96.2	96.2	96.0	95.9	95.6	95.3	95.0	94.7	94.4	94.0	93.7	93.3	92.9	92.4	92.0
60	95.6	95.6	95.6	95.6	95.5	95.5	95.3	95.1	94.9	94.7	94.4	94.1	93.8	93.5	93.2	92.8	92.4	92.0
65	94.9	94.9	94.9	94.9	94.9	94.9	94.8	94.6	94.5	94.3	94.0	93.8	93.6	93.3	93.0	92.7	92.4	92.0
70	94.2	94.2	94.2	94.2	94.2	94.2	94.1	94.1	94.0	93.8	93.7	93.5	93.4	93.1	92.9	92.6	92.3	92.0
75	93.5	93.5	93.5	93.5	93.5	93.5	93.5	93.5	93.4	93.4	93.3	93.2	93.1	92.9	92.7	92.5	92.2	92.0
80	92.9	92.9	92.9	92.9	92.9	92.9	92.9	92.9	92.9	92.9	92.9	92.9	92.8	92.6	92.5	92.3	92.2	92.0
85	92.5	92.5	92.5	92.5	92.5	92.5	92.5	92.5	92.5	92.5	92.5	92.5	92.4	92.4	92.3	92.2	92.1	92.0
90	92.1	92.1	92.1	92.1	92.1	92.1	92.1	92.1	92.1	92.1	92.1	92.1	92.1	92.1	92.1	92.1	92.0	92.0
95	92.0	92.0	92.0	92.0	92.0	92.0	92.0	92.0	92.0	92.0	92.0	92.0	92.0	92.0	92.0	92.0	92.0	92.0
98	92.0	92.0	92.0	92.0	92.0	92.0	92.0	92.0	92.0	92.0	92.0	92.0	92.0	92.0	92.0	92.0	92.0	92.0

Mean Annual Mass Removal Efficiencies (%) for 3.50-inches of Retention for Zone 3

NDCIA CN	Percent DCIA																	
	0-15	20	25	30	35	40	45	50	55	60	65	70	75	80	85	90	95	100
30	98.3	98.3	98.3	98.3	98.3	98.3	98.1	97.9	97.5	96.9	96.4	95.9	95.4	94.9	94.4	93.9	93.4	92.9
35	98.0	98.0	98.0	98.0	98.0	98.0	97.9	97.6	97.2	96.7	96.3	95.8	95.3	94.8	94.4	93.9	93.4	92.9
40	97.7	97.7	97.7	97.7	97.7	97.7	97.6	97.3	96.9	96.5	96.1	95.6	95.2	94.7	94.3	93.8	93.4	92.9
45	97.4	97.4	97.4	97.4	97.4	97.4	97.3	97.0	96.6	96.3	95.9	95.4	95.0	94.6	94.2	93.8	93.3	92.9
50	97.1	97.1	97.1	97.1	97.1	97.0	96.9	96.6	96.3	96.0	95.6	95.2	94.9	94.5	94.1	93.7	93.3	92.9
55	96.7	96.7	96.7	96.7	96.7	96.6	96.4	96.2	95.9	95.6	95.3	95.0	94.7	94.4	94.0	93.7	93.3	92.9
60	96.1	96.1	96.1	96.1	96.1	96.0	95.9	95.8	95.5	95.3	95.0	94.8	94.5	94.2	93.9	93.6	93.2	92.9
65	95.5	95.5	95.5	95.5	95.5	95.5	95.4	95.3	95.1	94.9	94.7	94.5	94.3	94.0	93.8	93.5	93.2	92.9
70	94.9	94.9	94.9	94.9	94.9	94.9	94.8	94.8	94.7	94.5	94.4	94.2	94.0	93.9	93.7	93.4	93.1	92.9
75	94.2	94.2	94.2	94.2	94.2	94.2	94.2	94.2	94.2	94.1	94.0	93.9	93.8	93.7	93.5	93.3	93.1	92.9
80	93.7	93.7	93.7	93.7	93.7	93.7	93.7	93.7	93.7	93.6	93.6	93.6	93.5	93.4	93.3	93.2	93.0	92.9
85	93.2	93.2	93.2	93.2	93.2	93.2	93.2	93.2	93.2	93.2	93.2	93.2	93.2	93.2	93.1	93.1	93.0	92.9
90	92.9	92.9	92.9	92.9	92.9	92.9	92.9	92.9	92.9	92.9	92.9	92.9	92.9	92.9	92.9	92.9	92.9	92.9
95	92.9	92.9	92.9	92.9	92.9	92.9	92.9	92.9	92.9	92.9	92.9	92.9	92.9	92.9	92.9	92.9	92.9	92.9
98	92.9	92.9	92.9	92.9	92.9	92.9	92.9	92.9	92.9	92.9	92.9	92.9	92.9	92.9	92.9	92.9	92.9	92.9



**Mean Annual Mass Removal Efficiencies (%) for 3.75-inches of Retention for Zone 3**

NDCIA CN	Percent DCIA																	
	0-15	20	25	30	35	40	45	50	55	60	65	70	75	80	85	90	95	100
30	98.4	98.4	98.4	98.4	98.4	98.4	98.3	98.2	97.9	97.5	97.0	96.5	96.0	95.5	95.0	94.6	94.1	93.6
35	98.2	98.2	98.2	98.2	98.2	98.2	98.1	97.9	97.7	97.3	96.8	96.3	95.9	95.4	95.0	94.5	94.1	93.6
40	97.9	97.9	97.9	97.9	97.9	97.9	97.9	97.7	97.4	97.0	96.6	96.2	95.8	95.3	94.9	94.5	94.1	93.6
45	97.7	97.7	97.7	97.7	97.7	97.7	97.6	97.4	97.1	96.8	96.4	96.0	95.6	95.2	94.8	94.5	94.1	93.6
50	97.4	97.4	97.4	97.4	97.4	97.4	97.3	97.1	96.8	96.5	96.2	95.8	95.5	95.1	94.8	94.4	94.0	93.6
55	97.0	97.0	97.0	97.0	97.0	97.0	96.9	96.7	96.5	96.2	95.9	95.6	95.3	95.0	94.7	94.3	94.0	93.6
60	96.6	96.6	96.6	96.6	96.6	96.6	96.4	96.3	96.1	95.9	95.6	95.4	95.1	94.8	94.6	94.3	94.0	93.6
65	96.1	96.1	96.1	96.1	96.1	96.0	96.0	95.9	95.7	95.5	95.3	95.1	94.9	94.7	94.4	94.2	93.9	93.6
70	95.5	95.5	95.5	95.5	95.5	95.5	95.5	95.4	95.3	95.2	95.0	94.8	94.7	94.5	94.3	94.1	93.9	93.6
75	94.9	94.9	94.9	94.9	94.9	94.9	94.9	94.9	94.8	94.7	94.7	94.5	94.4	94.3	94.2	94.0	93.8	93.6
80	94.3	94.3	94.3	94.3	94.3	94.3	94.3	94.3	94.3	94.3	94.3	94.2	94.2	94.1	94.0	93.9	93.8	93.6
85	93.9	93.9	93.9	93.9	93.9	93.9	93.9	93.9	93.9	93.9	93.9	93.9	93.9	93.9	93.8	93.8	93.7	93.6
90	93.7	93.7	93.7	93.7	93.7	93.7	93.7	93.7	93.7	93.7	93.7	93.7	93.7	93.7	93.7	93.7	93.7	93.6
95	93.6	93.6	93.6	93.6	93.6	93.6	93.6	93.6	93.6	93.6	93.6	93.6	93.6	93.6	93.6	93.6	93.6	93.6
98	93.6	93.6	93.6	93.6	93.6	93.6	93.6	93.6	93.6	93.6	93.6	93.6	93.6	93.6	93.6	93.6	93.6	93.6

**Mean Annual Mass Removal Efficiencies (%) for 4.00-inches of Retention for Zone 3**

NDCIA CN	Percent DCIA																	
	0-15	20	25	30	35	40	45	50	55	60	65	70	75	80	85	90	95	100
30	98.5	98.5	98.5	98.5	98.5	98.5	98.5	98.4	98.2	97.9	97.4	97.0	96.5	96.1	95.6	95.2	94.7	94.3
35	98.3	98.3	98.3	98.3	98.3	98.3	98.3	98.2	98.0	97.7	97.3	96.9	96.4	96.0	95.5	95.1	94.7	94.3
40	98.1	98.1	98.1	98.1	98.1	98.1	98.1	98.0	97.8	97.5	97.1	96.7	96.3	95.9	95.5	95.1	94.7	94.3
45	97.8	97.8	97.8	97.8	97.8	97.8	97.8	97.7	97.5	97.3	96.9	96.5	96.2	95.8	95.4	95.0	94.7	94.3
50	97.6	97.6	97.6	97.6	97.6	97.6	97.6	97.5	97.3	97.0	96.7	96.4	96.0	95.7	95.3	95.0	94.6	94.3
55	97.3	97.3	97.3	97.3	97.3	97.3	97.3	97.1	96.9	96.7	96.4	96.1	95.9	95.5	95.2	94.9	94.6	94.3
60	97.0	97.0	97.0	97.0	97.0	97.0	96.9	96.8	96.6	96.4	96.2	95.9	95.7	95.4	95.1	94.9	94.6	94.3
65	96.6	96.6	96.6	96.6	96.6	96.6	96.5	96.4	96.2	96.1	95.9	95.7	95.5	95.2	95.0	94.8	94.6	94.3
70	96.0	96.0	96.0	96.0	96.0	96.0	96.0	95.9	95.8	95.7	95.6	95.4	95.2	95.1	94.9	94.7	94.5	94.3
75	95.5	95.5	95.5	95.5	95.5	95.5	95.5	95.5	95.4	95.3	95.3	95.1	95.0	94.9	94.8	94.6	94.5	94.3
80	95.0	95.0	95.0	95.0	95.0	95.0	95.0	95.0	95.0	94.9	94.9	94.8	94.8	94.7	94.6	94.5	94.4	94.3
85	94.5	94.5	94.5	94.5	94.5	94.5	94.5	94.5	94.5	94.5	94.5	94.5	94.5	94.5	94.5	94.4	94.4	94.3
90	94.3	94.3	94.3	94.3	94.3	94.3	94.3	94.3	94.3	94.3	94.3	94.3	94.3	94.3	94.3	94.3	94.3	94.3
95	94.3	94.3	94.3	94.3	94.3	94.3	94.3	94.3	94.3	94.3	94.3	94.3	94.3	94.3	94.3	94.3	94.3	94.3
98	94.3	94.3	94.3	94.3	94.3	94.3	94.3	94.3	94.3	94.3	94.3	94.3	94.3	94.3	94.3	94.3	94.3	94.3



**Mean Annual Mass Removal Efficiencies (%) for 0.10-inches of Retention for Zone 4**

NDCIA CN	Percent DCIA																	
	0-15	20	25	30	35	40	45	50	55	60	65	70	75	80	85	90	95	100
30	50.2	41.7	35.6	31.0	27.4	24.6	22.4	20.5	18.9	17.5	16.3	15.3	14.3	13.5	12.8	12.2	11.6	11.1
35	49.3	41.1	35.2	30.7	27.3	24.5	22.3	20.4	18.8	17.4	16.3	15.2	14.3	13.5	12.8	12.2	11.6	11.1
40	48.2	40.4	34.8	30.4	27.0	24.3	22.1	20.3	18.7	17.4	16.2	15.2	14.3	13.5	12.8	12.2	11.6	11.1
45	46.7	39.6	34.2	30.0	26.6	24.1	22.0	20.2	18.6	17.3	16.2	15.2	14.3	13.5	12.8	12.2	11.6	11.1
50	45.0	38.5	33.4	29.5	26.4	23.9	21.8	20.1	18.5	17.2	16.1	15.1	14.2	13.5	12.8	12.2	11.6	11.1
55	42.9	37.1	32.5	28.9	25.9	23.5	21.5	19.9	18.4	17.1	16.0	15.0	14.2	13.4	12.8	12.1	11.6	11.1
60	40.5	35.6	31.5	28.1	25.4	23.1	21.2	19.6	18.2	17.0	15.9	15.0	14.1	13.4	12.7	12.1	11.6	11.1
65	37.8	33.7	30.2	27.2	24.7	22.6	20.8	19.3	18.0	16.8	15.8	14.9	14.1	13.3	12.7	12.1	11.6	11.1
70	34.8	31.6	28.7	26.1	23.9	22.0	20.3	18.9	17.7	16.6	15.6	14.7	14.0	13.3	12.6	12.1	11.6	11.1
75	31.4	29.1	26.8	24.7	22.8	21.1	19.7	18.5	17.3	16.3	15.4	14.6	13.8	13.2	12.6	12.0	11.5	11.1
80	27.6	26.2	24.6	22.9	21.4	20.1	18.9	17.8	16.8	15.9	15.1	14.3	13.7	13.0	12.5	12.0	11.5	11.1
85	23.4	22.8	21.8	20.8	19.7	18.7	17.7	16.9	16.0	15.3	14.6	14.0	13.4	12.8	12.4	11.9	11.5	11.1
90	19.0	18.9	18.6	18.0	17.4	16.8	16.2	15.6	15.0	14.4	13.9	13.4	13.0	12.5	12.1	11.8	11.4	11.1
95	14.8	14.8	14.7	14.6	14.4	14.2	13.9	13.7	13.4	13.1	12.8	12.6	12.3	12.0	11.8	11.5	11.3	11.1
98	12.8	12.8	12.7	12.6	12.5	12.4	12.3	12.2	12.1	12.0	11.9	11.8	11.6	11.5	11.4	11.3	11.2	11.1

**Mean Annual Mass Removal Efficiencies (%) for 0.20-inches of Retention for Zone 4**

NDCIA CN	Percent DCIA																	
	0-15	20	25	30	35	40	45	50	55	60	65	70	75	80	85	90	95	100
30	72.8	64.2	57.0	51.1	46.3	42.2	38.8	35.9	33.4	31.2	29.3	27.6	26.1	24.8	23.6	22.5	21.5	20.6
35	71.5	63.4	56.5	50.7	46.0	42.0	38.6	35.8	33.3	31.2	29.3	27.6	26.1	24.8	23.6	22.5	21.5	20.6
40	69.8	62.3	55.7	50.2	45.6	41.7	38.4	35.6	33.2	31.1	29.2	27.6	26.1	24.7	23.5	22.5	21.5	20.6
45	67.7	60.9	54.8	49.5	45.1	41.4	38.2	35.4	33.0	30.9	29.1	27.5	26.0	24.7	23.5	22.5	21.5	20.6
50	65.2	59.2	53.6	48.7	44.5	40.9	37.8	35.2	32.8	30.8	29.0	27.4	25.9	24.7	23.5	22.4	21.5	20.6
55	62.3	57.2	52.2	47.7	43.7	40.3	37.4	34.8	32.6	30.6	28.9	27.3	25.9	24.6	23.4	22.4	21.5	20.6
60	59.0	54.9	50.5	46.4	42.6	39.6	36.8	34.4	32.3	30.3	28.7	27.1	25.8	24.5	23.4	22.4	21.4	20.6
65	55.2	52.1	48.5	44.9	41.7	38.8	36.2	33.9	31.8	30.0	28.4	27.0	25.6	24.4	23.3	22.3	21.4	20.6
70	51.0	48.9	46.1	43.1	40.2	37.7	35.3	33.2	31.3	29.6	28.1	26.7	25.4	24.3	23.2	22.3	21.4	20.6
75	46.3	45.3	43.2	40.8	38.5	36.3	34.2	32.4	30.6	29.1	27.7	26.4	25.2	24.1	23.1	22.2	21.4	20.6
80	41.2	41.0	39.7	38.0	36.2	34.5	32.8	31.2	29.7	28.4	27.1	26.0	24.9	23.9	23.0	22.1	21.3	20.6
85	36.0	36.0	35.5	34.5	33.4	32.1	30.9	29.7	28.5	27.4	26.3	25.3	24.4	23.5	22.7	22.0	21.3	20.6
90	30.7	30.7	30.6	30.2	29.6	29.0	28.2	27.4	26.6	25.9	25.1	24.4	23.7	23.0	22.3	21.7	21.1	20.6
95	25.4	25.4	25.4	25.3	25.1	24.9	24.6	24.3	23.9	23.6	23.2	22.8	22.4	22.1	21.7	21.3	20.9	20.6
98	22.8	22.7	22.6	22.6	22.5	22.4	22.2	22.1	22.0	21.8	21.7	21.5	21.4	21.2	21.1	20.9	20.8	20.6



Mean Annual Mass Removal Efficiencies (%) for 0.30-inches of Retention for Zone 4

NDCIA CN	Percent DCIA																	
	0-15	20	25	30	35	40	45	50	55	60	65	70	75	80	85	90	95	100
30	83.7	76.9	70.5	64.8	59.7	55.3	51.4	48.0	45.0	42.4	40.0	37.9	36.1	34.3	32.7	31.3	30.0	28.8
35	82.2	75.9	69.8	64.3	59.3	55.0	51.2	47.9	44.9	42.3	40.0	37.9	36.0	34.3	32.7	31.3	30.0	28.8
40	80.3	74.7	68.9	63.6	58.9	54.6	50.9	47.7	44.7	42.2	39.9	37.8	36.0	34.2	32.7	31.3	30.0	28.8
45	78.0	73.0	67.8	62.8	58.2	54.2	50.6	47.4	44.5	42.0	39.7	37.7	35.9	34.2	32.7	31.3	30.0	28.8
50	75.3	71.1	66.3	61.7	57.4	53.6	50.1	47.0	44.3	41.8	39.6	37.6	35.8	34.1	32.6	31.2	30.0	28.8
55	72.1	68.8	64.6	60.4	56.5	52.8	49.5	46.6	43.9	41.5	39.4	37.4	35.7	34.0	32.6	31.2	30.0	28.8
60	68.5	66.0	62.6	58.9	55.3	51.9	48.8	46.0	43.5	41.2	39.1	37.2	35.5	33.9	32.5	31.2	30.0	28.8
65	64.5	62.9	60.2	57.0	53.8	50.8	47.9	45.3	42.9	40.8	38.8	37.0	35.3	33.8	32.4	31.1	29.9	28.8
70	60.0	59.3	57.3	54.7	52.0	49.3	46.8	44.4	42.2	40.2	38.4	36.7	35.1	33.6	32.3	31.0	29.9	28.8
75	55.1	55.1	53.9	52.0	49.8	47.6	45.4	43.3	41.3	39.5	37.8	36.2	34.8	33.4	32.1	30.9	29.8	28.8
80	50.2	50.2	49.7	48.6	47.0	45.3	43.5	41.8	40.1	38.5	37.0	35.6	34.3	33.1	31.9	30.8	29.8	28.8
85	45.0	45.0	44.9	44.3	43.4	42.3	41.0	39.8	38.4	37.2	36.0	34.8	33.7	32.6	31.6	30.6	29.7	28.8
90	39.6	39.6	39.6	39.4	39.0	38.4	37.7	36.9	36.1	35.2	34.3	33.5	32.7	31.8	31.0	30.3	29.5	28.8
95	34.1	34.1	34.1	34.0	33.8	33.6	33.3	33.0	32.7	32.3	31.9	31.5	31.0	30.6	30.1	29.7	29.3	28.8
98	31.2	31.2	31.1	31.0	30.9	30.8	30.6	30.5	30.4	30.2	30.1	29.9	29.7	29.6	29.4	29.2	29.0	28.8

Mean Annual Mass Removal Efficiencies (%) for 0.40-inches of Retention for Zone 4

NDCIA CN	Percent DCIA																	
	0-15	20	25	30	35	40	45	50	55	60	65	70	75	80	85	90	95	100
30	89.1	84.4	79.1	74.1	69.3	65.0	61.1	57.6	54.4	51.6	49.0	46.6	44.4	42.5	40.7	39.0	37.5	36.1
35	87.6	83.3	78.4	73.5	68.9	64.7	60.9	57.4	54.3	51.4	48.9	46.5	44.4	42.5	40.7	39.0	37.5	36.1
40	85.8	81.9	77.4	72.8	68.4	64.3	60.6	57.2	54.1	51.3	48.8	46.4	44.3	42.4	40.6	39.0	37.5	36.1
45	83.5	80.2	76.1	71.8	67.6	63.7	60.1	56.8	53.8	51.1	48.6	46.3	44.2	42.4	40.6	39.0	37.5	36.1
50	80.8	78.2	74.6	70.6	66.7	63.0	59.6	56.4	53.5	50.8	48.4	46.2	44.1	42.3	40.5	38.9	37.5	36.1
55	77.8	75.8	72.7	69.2	65.6	62.2	58.9	55.9	53.1	50.5	48.2	46.0	44.0	42.2	40.5	38.9	37.4	36.1
60	74.2	73.0	70.5	67.5	64.3	61.1	58.1	55.2	52.6	50.1	47.8	45.7	43.8	42.0	40.4	38.8	37.4	36.1
65	70.3	69.8	67.9	65.4	62.6	59.8	57.0	54.4	51.9	49.6	47.4	45.4	43.6	41.9	40.3	38.8	37.4	36.1
70	66.0	66.0	64.8	62.9	60.6	58.2	55.7	53.4	51.1	48.9	46.9	45.0	43.3	41.7	40.1	38.7	37.4	36.1
75	61.7	61.7	61.2	59.9	58.1	56.1	54.1	52.0	50.0	48.1	46.2	44.5	42.9	41.4	39.9	38.6	37.3	36.1
80	57.0	57.0	56.9	56.2	55.0	53.6	51.9	50.3	48.6	46.9	45.3	43.8	42.3	41.0	39.6	38.4	37.2	36.1
85	52.0	52.0	52.0	51.7	51.1	50.2	49.1	47.9	46.6	45.3	44.0	42.8	41.5	40.4	39.2	38.1	37.1	36.1
90	46.8	46.8	46.8	46.8	46.4	46.0	45.3	44.6	43.8	43.0	42.1	41.2	40.3	39.5	38.6	37.7	36.9	36.1
95	41.4	41.4	41.4	41.3	41.2	41.0	40.7	40.4	40.1	39.7	39.3	38.9	38.5	38.0	37.5	37.1	36.6	36.1
98	38.5	38.4	38.4	38.3	38.2	38.1	37.9	37.8	37.7	37.5	37.4	37.2	37.0	36.9	36.7	36.5	36.3	36.1



**Mean Annual Mass Removal Efficiencies (%) for 0.50-inches of Retention for Zone 4**

NDCIA CN	Percent DCIA																	
	0-15	20	25	30	35	40	45	50	55	60	65	70	75	80	85	90	95	100
30	92.1	88.8	84.8	80.5	76.3	72.4	68.6	65.2	62.0	59.1	56.4	53.9	51.7	49.5	47.6	45.8	44.1	42.6
35	90.7	87.7	84.0	79.9	75.9	72.0	68.4	65.0	61.9	59.0	56.3	53.9	51.6	49.5	47.6	45.8	44.1	42.6
40	88.9	86.4	82.9	79.1	75.3	71.5	68.0	64.7	61.6	58.8	56.2	53.8	51.5	49.4	47.5	45.7	44.1	42.6
45	86.8	84.7	81.6	78.1	74.5	70.9	67.5	64.3	61.3	58.6	56.0	53.6	51.4	49.4	47.5	45.7	44.1	42.6
50	84.3	82.7	80.1	76.9	73.5	70.2	66.9	63.9	61.0	58.3	55.8	53.5	51.3	49.3	47.4	45.7	44.1	42.6
55	81.4	80.4	78.2	75.4	72.3	69.2	66.2	63.3	60.5	57.9	55.5	53.2	51.1	49.2	47.3	45.6	44.0	42.6
60	78.1	77.6	75.9	73.6	70.9	68.0	65.2	62.5	59.9	57.4	55.1	53.0	50.9	49.0	47.2	45.6	44.0	42.6
65	74.5	74.5	73.3	71.4	69.1	66.6	64.1	61.6	59.2	56.9	54.7	52.6	50.6	48.8	47.1	45.5	44.0	42.6
70	70.8	70.8	70.2	68.9	67.0	64.9	62.7	60.5	58.3	56.1	54.1	52.1	50.3	48.6	46.9	45.4	43.9	42.6
75	66.7	66.7	66.6	65.7	64.4	62.7	60.9	59.0	57.1	55.2	53.3	51.5	49.8	48.2	46.7	45.2	43.8	42.6
80	62.4	62.4	62.4	61.9	61.1	59.9	58.6	57.1	55.5	53.9	52.3	50.7	49.2	47.8	46.4	45.0	43.8	42.6
85	57.7	57.7	57.7	57.6	57.1	56.4	55.5	54.5	53.3	52.1	50.8	49.6	48.3	47.1	45.9	44.7	43.6	42.6
90	52.8	52.8	52.8	52.8	52.6	52.2	51.7	51.1	50.3	49.6	48.7	47.9	47.0	46.1	45.2	44.3	43.4	42.6
95	47.6	47.6	47.6	47.6	47.5	47.3	47.1	46.8	46.5	46.2	45.8	45.4	44.9	44.5	44.0	43.5	43.0	42.6
98	44.8	44.8	44.7	44.7	44.6	44.5	44.3	44.2	44.1	44.0	43.8	43.6	43.5	43.3	43.1	42.9	42.7	42.6

**Mean Annual Mass Removal Efficiencies (%) for 0.60-inches of Retention for Zone 4**

NDCIA CN	Percent DCIA																	
	0-15	20	25	30	35	40	45	50	55	60	65	70	75	80	85	90	95	100
30	94.0	91.6	88.6	85.1	81.5	77.9	74.5	71.3	68.2	65.3	62.6	60.1	57.8	55.6	53.6	51.7	49.9	48.3
35	92.6	90.6	87.7	84.5	81.0	77.5	74.2	71.0	68.0	65.2	62.5	60.1	57.8	55.6	53.6	51.7	49.9	48.3
40	91.0	89.2	86.7	83.6	80.3	77.0	73.8	70.7	67.8	65.0	62.4	59.9	57.7	55.5	53.5	51.7	49.9	48.3
45	89.0	87.6	85.4	82.6	79.5	76.4	73.3	70.3	67.4	64.7	62.2	59.8	57.6	55.4	53.5	51.6	49.9	48.3
50	86.7	85.7	83.8	81.3	78.5	75.6	72.6	69.8	67.0	64.4	61.9	59.6	57.4	55.3	53.4	51.6	49.9	48.3
55	84.0	83.5	82.0	79.8	77.3	74.6	71.8	69.1	66.5	64.0	61.6	59.4	57.2	55.2	53.3	51.5	49.9	48.3
60	80.9	80.9	79.8	78.0	75.8	73.4	70.9	68.3	65.9	63.5	61.2	59.0	57.0	55.0	53.2	51.5	49.8	48.3
65	77.9	77.9	77.3	75.9	74.0	71.9	69.6	67.4	65.1	62.9	60.7	58.7	56.7	54.8	53.1	51.4	49.8	48.3
70	74.5	74.5	74.2	73.3	71.9	70.1	68.2	66.1	64.1	62.1	60.1	58.2	56.3	54.5	52.9	51.3	49.7	48.3
75	70.8	70.8	70.8	70.2	69.2	67.8	66.3	64.6	62.8	61.0	59.2	57.5	55.8	54.2	52.6	51.1	49.7	48.3
80	66.8	66.8	66.8	66.6	65.9	65.0	63.9	62.6	61.1	59.6	58.1	56.6	55.1	53.7	52.3	50.9	49.5	48.3
85	62.5	62.5	62.5	62.4	62.1	61.5	60.8	59.9	58.8	57.7	56.6	55.4	54.1	52.9	51.7	50.5	49.4	48.3
90	57.9	57.9	57.9	57.9	57.8	57.5	57.0	56.5	55.9	55.1	54.4	53.5	52.7	51.8	51.0	50.0	49.2	48.3
95	53.0	53.0	53.0	53.0	52.9	52.8	52.6	52.4	52.1	51.8	51.4	51.0	50.6	50.2	49.7	49.3	48.8	48.3
98	50.4	50.4	50.3	50.3	50.2	50.1	50.0	49.9	49.7	49.6	49.5	49.3	49.2	49.0	48.8	48.7	48.5	48.3



**Mean Annual Mass Removal Efficiencies (%) for 0.70-inches of Retention for Zone 4**

NDCIA CN	Percent DCIA																	
	0-15	20	25	30	35	40	45	50	55	60	65	70	75	80	85	90	95	100
30	95.2	93.4	91.1	88.3	85.3	82.2	79.1	76.1	73.2	70.5	67.9	65.4	63.1	60.9	58.9	56.9	55.1	53.4
35	94.0	92.4	90.3	87.7	84.8	81.8	78.8	75.8	73.0	70.3	67.7	65.3	63.0	60.9	58.8	56.9	55.1	53.4
40	92.4	91.2	89.3	86.9	84.1	81.2	78.3	75.5	72.7	70.1	67.6	65.2	62.9	60.8	58.8	56.9	55.1	53.4
45	90.6	89.7	88.0	85.8	83.3	80.6	77.8	75.1	72.4	69.8	67.4	65.0	62.8	60.7	58.7	56.8	55.1	53.4
50	88.5	87.9	86.5	84.6	82.3	79.7	77.1	74.5	72.0	69.5	67.1	64.8	62.6	60.6	58.6	56.8	55.0	53.4
55	86.0	85.8	84.8	83.1	81.1	78.7	76.3	73.9	71.4	69.0	66.7	64.5	62.4	60.4	58.5	56.7	55.0	53.4
60	83.4	83.4	82.7	81.4	79.6	77.5	75.3	73.0	70.7	68.5	66.3	64.2	62.2	60.3	58.4	56.6	55.0	53.4
65	80.6	80.6	80.3	79.3	77.8	76.0	74.1	72.0	69.9	67.8	65.8	63.8	61.9	60.0	58.2	56.5	54.9	53.4
70	77.4	77.4	77.4	76.8	75.7	74.2	72.6	70.8	68.9	67.0	65.1	63.3	61.5	59.7	58.0	56.4	54.9	53.4
75	74.1	74.1	74.1	73.8	73.1	72.0	70.6	69.1	67.6	65.9	64.2	62.6	60.9	59.3	57.8	56.2	54.8	53.4
80	70.5	70.5	70.5	70.4	69.9	69.2	68.2	67.0	65.8	64.5	63.1	61.6	60.2	58.8	57.4	56.0	54.7	53.4
85	66.5	66.5	66.5	66.5	66.3	65.8	65.2	64.4	63.5	62.5	61.4	60.3	59.2	58.0	56.8	55.7	54.5	53.4
90	62.2	62.2	62.2	62.2	62.1	61.9	61.6	61.1	60.6	59.9	59.2	58.5	57.7	56.8	56.0	55.1	54.3	53.4
95	57.6	57.6	57.6	57.6	57.6	57.5	57.4	57.2	57.0	56.7	56.3	56.0	55.6	55.2	54.8	54.3	53.9	53.4
98	55.3	55.3	55.2	55.2	55.1	55.0	54.9	54.8	54.7	54.6	54.5	54.4	54.2	54.1	53.9	53.7	53.6	53.4

**Mean Annual Mass Removal Efficiencies (%) for 0.80-inches of Retention for Zone 4**

NDCIA CN	Percent DCIA																	
	0-15	20	25	30	35	40	45	50	55	60	65	70	75	80	85	90	95	100
30	96.0	94.7	92.9	90.7	88.2	85.5	82.7	80.0	77.3	74.7	72.2	69.9	67.6	65.5	63.4	61.5	59.7	57.9
35	94.9	93.8	92.1	90.0	87.6	85.1	82.4	79.7	77.1	74.6	72.1	69.8	67.5	65.4	63.4	61.5	59.6	57.9
40	93.5	92.6	91.2	89.2	87.0	84.5	81.9	79.4	76.8	74.3	71.9	69.6	67.4	65.3	63.3	61.4	59.6	57.9
45	91.9	91.2	90.0	88.2	86.2	83.8	81.4	78.9	76.4	74.0	71.7	69.5	67.3	65.2	63.3	61.4	59.6	57.9
50	89.9	89.6	88.6	87.0	85.2	83.0	80.7	78.4	76.0	73.7	71.4	69.2	67.1	65.1	63.2	61.4	59.6	57.9
55	87.6	87.6	86.9	85.6	84.0	82.0	79.9	77.7	75.4	73.2	71.1	69.0	66.9	65.0	63.1	61.3	59.6	57.9
60	85.3	85.3	84.9	84.0	82.5	80.8	78.9	76.8	74.8	72.7	70.6	68.6	66.6	64.8	62.9	61.2	59.5	57.9
65	82.7	82.7	82.6	81.9	80.8	79.3	77.6	75.8	73.9	72.0	70.1	68.2	66.3	64.5	62.8	61.1	59.5	57.9
70	80.0	80.0	80.0	79.5	78.7	77.5	76.1	74.5	72.9	71.1	69.4	67.6	65.9	64.2	62.5	61.0	59.4	57.9
75	76.9	76.9	76.9	76.7	76.2	75.3	74.2	72.9	71.5	70.0	68.5	66.9	65.3	63.8	62.3	60.8	59.3	57.9
80	73.6	73.6	73.6	73.6	73.2	72.6	71.8	70.8	69.7	68.5	67.2	65.9	64.6	63.2	61.9	60.5	59.2	57.9
85	70.0	70.0	70.0	70.0	69.8	69.5	68.9	68.2	67.4	66.6	65.6	64.6	63.5	62.4	61.3	60.2	59.0	57.9
90	66.0	66.0	66.0	66.0	66.0	65.8	65.5	65.1	64.6	64.1	63.4	62.7	62.0	61.2	60.4	59.6	58.8	57.9
95	61.7	61.7	61.7	61.7	61.7	61.7	61.6	61.4	61.2	60.9	60.7	60.4	60.0	59.6	59.2	58.8	58.4	57.9
98	59.6	59.6	59.6	59.5	59.5	59.4	59.3	59.2	59.1	59.0	58.9	58.8	58.7	58.5	58.4	58.2	58.1	57.9



**Mean Annual Mass Removal Efficiencies (%) for 0.90-inches of Retention for Zone 4**

NDCIA CN	Percent DCIA																	
	0-15	20	25	30	35	40	45	50	55	60	65	70	75	80	85	90	95	100
30	96.7	95.7	94.2	92.4	90.3	88.0	85.6	83.1	80.7	78.3	75.9	73.7	71.5	69.4	67.4	65.5	63.7	62.0
35	95.7	94.8	93.5	91.8	89.8	87.6	85.3	82.8	80.4	78.1	75.8	73.6	71.4	69.4	67.4	65.5	63.7	62.0
40	94.4	93.7	92.5	91.0	89.1	87.0	84.8	82.5	80.2	77.9	75.6	73.4	71.3	69.3	67.3	65.5	63.7	62.0
45	92.8	92.4	91.4	90.0	88.3	86.4	84.3	82.0	79.8	77.6	75.4	73.2	71.2	69.2	67.2	65.4	63.6	62.0
50	91.0	90.9	90.1	88.9	87.4	85.6	83.6	81.5	79.3	77.2	75.1	73.0	71.0	69.0	67.2	65.4	63.6	62.0
55	89.0	89.0	88.5	87.6	86.2	84.6	82.7	80.8	78.8	76.7	74.7	72.7	70.8	68.9	67.0	65.3	63.6	62.0
60	86.9	86.9	86.7	86.0	84.8	83.4	81.7	79.9	78.1	76.2	74.3	72.4	70.5	68.7	66.9	65.2	63.5	62.0
65	84.5	84.5	84.5	84.1	83.2	82.0	80.5	78.9	77.2	75.5	73.7	71.9	70.2	68.4	66.7	65.1	63.5	62.0
70	82.1	82.1	82.1	81.8	81.2	80.2	79.0	77.7	76.2	74.6	73.0	71.3	69.7	68.1	66.5	64.9	63.4	62.0
75	79.3	79.3	79.3	79.2	78.8	78.1	77.2	76.1	74.8	73.5	72.0	70.6	69.1	67.7	66.2	64.8	63.3	62.0
80	76.3	76.3	76.3	76.3	76.0	75.6	74.9	74.0	73.1	72.0	70.8	69.6	68.3	67.1	65.8	64.5	63.2	62.0
85	73.0	73.0	73.0	73.0	72.9	72.6	72.1	71.5	70.8	70.0	69.2	68.2	67.3	66.2	65.2	64.1	63.0	62.0
90	69.3	69.3	69.3	69.3	69.3	69.1	68.9	68.6	68.1	67.6	67.1	66.5	65.8	65.1	64.3	63.6	62.8	62.0
95	65.3	65.3	65.3	65.3	65.3	65.3	65.2	65.1	64.9	64.7	64.4	64.2	63.9	63.5	63.2	62.8	62.4	62.0
98	63.4	63.4	63.4	63.3	63.3	63.3	63.2	63.1	63.0	62.9	62.9	62.8	62.6	62.5	62.4	62.2	62.1	62.0

**Mean Annual Mass Removal Efficiencies (%) for 1.00-inches of Retention for Zone 4**

NDCIA CN	Percent DCIA																	
	0-15	20	25	30	35	40	45	50	55	60	65	70	75	80	85	90	95	100
30	97.2	96.4	95.2	93.7	91.9	90.0	87.9	85.7	83.5	81.2	79.0	76.9	74.8	72.8	70.9	69.1	67.3	65.6
35	96.2	95.6	94.5	93.1	91.4	89.6	87.5	85.4	83.2	81.1	78.9	76.8	74.8	72.8	70.9	69.0	67.2	65.6
40	95.1	94.6	93.6	92.4	90.8	89.0	87.1	85.1	82.9	80.8	78.7	76.7	74.7	72.7	70.8	69.0	67.2	65.6
45	93.6	93.4	92.6	91.5	90.0	88.4	86.5	84.6	82.6	80.5	78.5	76.5	74.5	72.6	70.7	68.9	67.2	65.6
50	92.0	91.9	91.4	90.4	89.1	87.6	85.9	84.0	82.1	80.1	78.2	76.2	74.3	72.5	70.6	68.9	67.2	65.6
55	90.2	90.2	89.9	89.1	88.0	86.6	85.1	83.4	81.5	79.7	77.8	75.9	74.1	72.3	70.5	68.8	67.1	65.6
60	88.3	88.3	88.1	87.6	86.7	85.5	84.1	82.5	80.8	79.1	77.3	75.6	73.8	72.1	70.4	68.7	67.1	65.6
65	86.1	86.1	86.1	85.8	85.1	84.1	82.9	81.5	80.0	78.4	76.8	75.1	73.5	71.8	70.2	68.6	67.1	65.6
70	83.9	83.9	83.9	83.7	83.2	82.4	81.4	80.3	78.9	77.5	76.0	74.5	73.0	71.5	70.0	68.5	67.0	65.6
75	81.3	81.3	81.3	81.3	81.0	80.4	79.6	78.7	77.6	76.4	75.1	73.8	72.4	71.0	69.6	68.3	66.9	65.6
80	78.6	78.6	78.6	78.6	78.4	78.1	77.5	76.8	75.9	74.9	73.9	72.8	71.6	70.4	69.2	68.0	66.8	65.6
85	75.6	75.6	75.6	75.6	75.5	75.3	74.9	74.4	73.8	73.1	72.3	71.4	70.5	69.6	68.6	67.6	66.6	65.6
90	72.2	72.2	72.2	72.2	72.2	72.1	71.9	71.6	71.2	70.8	70.3	69.7	69.1	68.5	67.8	67.1	66.3	65.6
95	68.5	68.5	68.5	68.5	68.5	68.5	68.4	68.3	68.2	68.0	67.8	67.6	67.3	67.0	66.7	66.3	65.9	65.6
98	66.8	66.8	66.8	66.7	66.7	66.7	66.6	66.6	66.5	66.4	66.3	66.3	66.1	66.0	65.9	65.8	65.7	65.6



Mean Annual Mass Removal Efficiencies (%) for 1.25-inches of Retention for Zone 4

NDCIA CN	Percent DCIA																	
	0-15	20	25	30	35	40	45	50	55	60	65	70	75	80	85	90	95	100
30	98.0	97.5	96.8	95.8	94.6	93.3	91.8	90.2	88.5	86.8	85.0	83.2	81.4	79.6	77.9	76.2	74.5	72.9
35	97.3	96.9	96.2	95.3	94.2	92.9	91.5	89.9	88.3	86.6	84.8	83.0	81.3	79.5	77.8	76.2	74.5	72.9
40	96.3	96.1	95.5	94.6	93.6	92.4	91.1	89.6	88.0	86.3	84.6	82.9	81.2	79.5	77.8	76.1	74.5	72.9
45	95.1	95.0	94.6	93.9	93.0	91.8	90.6	89.1	87.6	86.0	84.4	82.7	81.0	79.3	77.7	76.1	74.5	72.9
50	93.8	93.8	93.6	93.0	92.1	91.1	89.9	88.6	87.2	85.7	84.1	82.4	80.8	79.2	77.6	76.0	74.5	72.9
55	92.5	92.5	92.3	91.9	91.2	90.3	89.2	88.0	86.6	85.2	83.7	82.1	80.6	79.0	77.5	75.9	74.4	72.9
60	90.9	90.9	90.9	90.6	90.0	89.2	88.3	87.2	86.0	84.6	83.2	81.8	80.3	78.8	77.3	75.8	74.4	72.9
65	89.2	89.2	89.2	89.0	88.6	88.0	87.2	86.3	85.2	84.0	82.7	81.3	79.9	78.5	77.1	75.7	74.3	72.9
70	87.4	87.4	87.4	87.3	87.0	86.6	85.9	85.1	84.2	83.1	82.0	80.7	79.5	78.2	76.9	75.6	74.3	72.9
75	85.4	85.4	85.4	85.4	85.2	84.9	84.4	83.7	82.9	82.0	81.1	80.0	78.9	77.7	76.6	75.4	74.2	72.9
80	83.2	83.2	83.2	83.2	83.1	82.9	82.5	82.0	81.4	80.7	79.9	79.1	78.1	77.1	76.1	75.1	74.0	72.9
85	80.7	80.7	80.7	80.7	80.7	80.6	80.4	80.1	79.6	79.1	78.5	77.8	77.1	76.4	75.5	74.7	73.8	72.9
90	78.1	78.1	78.1	78.1	78.1	78.0	77.9	77.7	77.5	77.1	76.8	76.3	75.9	75.3	74.8	74.2	73.6	72.9
95	75.1	75.1	75.1	75.1	75.1	75.1	75.1	75.0	74.9	74.8	74.6	74.5	74.3	74.0	73.8	73.5	73.3	72.9
98	73.7	73.7	73.7	73.7	73.7	73.7	73.7	73.6	73.6	73.6	73.5	73.4	73.4	73.3	73.2	73.1	73.0	72.9

Mean Annual Mass Removal Efficiencies (%) for 1.50-inches of Retention for Zone 4

NDCIA CN	Percent DCIA																	
	0-15	20	25	30	35	40	45	50	55	60	65	70	75	80	85	90	95	100
30	98.5	98.2	97.7	97.1	96.2	95.3	94.2	93.0	91.7	90.4	89.0	87.5	86.0	84.5	83.0	81.5	80.0	78.5
35	97.9	97.7	97.3	96.6	95.8	94.9	93.9	92.8	91.5	90.2	88.8	87.4	85.9	84.4	82.9	81.4	80.0	78.5
40	97.1	97.0	96.6	96.1	95.4	94.5	93.5	92.4	91.2	89.9	88.6	87.2	85.8	84.3	82.9	81.4	80.0	78.5
45	96.2	96.2	95.9	95.4	94.8	94.0	93.1	92.0	90.9	89.7	88.4	87.0	85.6	84.2	82.8	81.3	79.9	78.5
50	95.2	95.2	95.0	94.6	94.1	93.3	92.5	91.5	90.5	89.3	88.1	86.8	85.4	84.1	82.7	81.3	79.9	78.5
55	94.0	94.0	94.0	93.7	93.2	92.6	91.8	91.0	90.0	88.9	87.7	86.5	85.2	83.9	82.5	81.2	79.9	78.5
60	92.8	92.8	92.8	92.6	92.2	91.7	91.0	90.3	89.4	88.4	87.3	86.1	84.9	83.7	82.4	81.1	79.8	78.5
65	91.4	91.4	91.4	91.3	91.1	90.6	90.1	89.4	88.6	87.7	86.8	85.7	84.6	83.4	82.2	81.0	79.8	78.5
70	89.9	89.9	89.9	89.9	89.7	89.4	89.0	88.4	87.7	87.0	86.1	85.1	84.1	83.1	82.0	80.8	79.7	78.5
75	88.3	88.3	88.3	88.3	88.2	88.0	87.7	87.2	86.7	86.0	85.3	84.4	83.6	82.6	81.6	80.6	79.6	78.5
80	86.5	86.5	86.5	86.5	86.5	86.4	86.2	85.8	85.4	84.9	84.3	83.6	82.9	82.1	81.2	80.4	79.5	78.5
85	84.5	84.5	84.5	84.5	84.5	84.5	84.4	84.2	83.9	83.5	83.0	82.5	82.0	81.4	80.7	80.0	79.3	78.5
90	82.4	82.4	82.4	82.4	82.4	82.4	82.4	82.2	82.1	81.8	81.6	81.2	80.9	80.5	80.0	79.6	79.1	78.5
95	80.1	80.1	80.1	80.1	80.1	80.1	80.1	80.1	80.0	79.9	79.8	79.7	79.6	79.4	79.2	79.0	78.8	78.5
98	79.1	79.1	79.1	79.1	79.1	79.1	79.0	79.0	79.0	79.0	79.0	78.9	78.9	78.8	78.7	78.7	78.6	78.5



**Mean Annual Mass Removal Efficiencies (%) for 1.75-inches of Retention for Zone 4**

NDCIA CN	Percent DCIA																	
	0-15	20	25	30	35	40	45	50	55	60	65	70	75	80	85	90	95	100
30	98.8	98.7	98.4	97.9	97.3	96.5	95.7	94.8	93.8	92.8	91.7	90.5	89.3	88.0	86.7	85.4	84.1	82.8
35	98.3	98.2	97.9	97.5	96.9	96.2	95.5	94.6	93.6	92.6	91.5	90.4	89.2	87.9	86.7	85.4	84.1	82.8
40	97.7	97.7	97.4	97.0	96.5	95.9	95.1	94.3	93.4	92.4	91.3	90.2	89.0	87.8	86.6	85.4	84.1	82.8
45	97.0	97.0	96.8	96.5	96.0	95.4	94.7	93.9	93.1	92.1	91.1	90.0	88.9	87.7	86.5	85.3	84.1	82.8
50	96.1	96.1	96.0	95.8	95.4	94.8	94.2	93.5	92.7	91.8	90.8	89.8	88.7	87.6	86.4	85.2	84.0	82.8
55	95.2	95.2	95.2	95.0	94.6	94.2	93.6	93.0	92.2	91.4	90.5	89.5	88.5	87.4	86.3	85.2	84.0	82.8
60	94.2	94.2	94.2	94.0	93.6	93.4	92.9	92.4	91.7	90.9	90.1	89.2	88.2	87.2	86.2	85.1	83.9	82.8
65	93.0	93.0	93.0	93.0	92.8	92.5	92.1	91.6	91.0	90.4	89.6	88.8	87.9	87.0	86.0	84.9	83.9	82.8
70	91.8	91.8	91.8	91.8	91.7	91.5	91.2	90.7	90.3	89.7	89.0	88.3	87.5	86.6	85.7	84.8	83.8	82.8
75	90.5	90.5	90.5	90.5	90.4	90.3	90.1	89.7	89.3	88.9	88.3	87.7	87.0	86.2	85.4	84.6	83.7	82.8
80	89.0	89.0	89.0	89.0	89.0	88.9	88.8	88.6	88.3	87.9	87.4	86.9	86.4	85.7	85.1	84.4	83.6	82.8
85	87.4	87.4	87.4	87.4	87.4	87.4	87.3	87.2	87.0	86.7	86.4	86.0	85.6	85.1	84.6	84.0	83.4	82.8
90	85.7	85.7	85.7	85.7	85.7	85.7	85.7	85.6	85.5	85.4	85.2	84.9	84.7	84.4	84.0	83.7	83.3	82.8
95	83.9	83.9	83.9	83.9	83.9	83.9	83.9	83.9	83.9	83.8	83.8	83.7	83.6	83.5	83.3	83.2	83.0	82.8
98	83.2	83.2	83.2	83.2	83.2	83.2	83.2	83.1	83.1	83.1	83.1	83.1	83.0	83.0	83.0	82.9	82.9	82.8

**Mean Annual Mass Removal Efficiencies (%) for 2.00-inches of Retention for Zone 4**

NDCIA CN	Percent DCIA																	
	0-15	20	25	30	35	40	45	50	55	60	65	70	75	80	85	90	95	100
30	99.1	99.0	98.7	98.4	98.0	97.4	96.8	96.1	95.3	94.5	93.6	92.6	91.6	90.6	89.5	88.4	87.3	86.1
35	98.6	98.6	98.4	98.1	97.7	97.1	96.5	95.9	95.1	94.3	93.4	92.5	91.5	90.5	89.4	88.4	87.3	86.1
40	98.1	98.1	98.0	97.7	97.3	96.8	96.2	95.6	94.9	94.1	93.3	92.4	91.4	90.4	89.4	88.3	87.2	86.1
45	97.6	97.6	97.5	97.2	96.8	96.4	95.9	95.3	94.6	93.8	93.0	92.2	91.3	90.3	89.3	88.3	87.2	86.1
50	96.9	96.9	96.8	96.6	96.3	95.9	95.4	94.9	94.2	93.6	92.8	92.0	91.1	90.2	89.2	88.2	87.2	86.1
55	96.1	96.1	96.1	95.9	95.7	95.3	94.9	94.4	93.8	93.2	92.5	91.7	90.9	90.0	89.1	88.1	87.1	86.1
60	95.2	95.2	95.2	95.1	95.0	94.7	94.3	93.9	93.4	92.8	92.1	91.4	90.6	89.8	88.9	88.0	87.1	86.1
65	94.3	94.3	94.3	94.3	94.1	93.9	93.6	93.2	92.8	92.3	91.7	91.0	90.3	89.6	88.8	87.9	87.1	86.1
70	93.2	93.2	93.2	93.2	93.2	93.0	92.8	92.5	92.1	91.7	91.2	90.6	90.0	89.3	88.6	87.8	87.0	86.1
75	92.1	92.1	92.1	92.1	92.1	92.0	91.9	91.6	91.3	91.0	90.5	90.1	89.5	88.9	88.3	87.6	86.9	86.1
80	90.9	90.9	90.9	90.9	90.9	90.9	90.8	90.6	90.4	90.1	89.8	89.4	89.0	88.5	88.0	87.4	86.8	86.1
85	89.6	89.6	89.6	89.6	89.6	89.6	89.6	89.5	89.4	89.2	88.9	88.7	88.3	88.0	87.6	87.1	86.6	86.1
90	88.3	88.3	88.3	88.3	88.3	88.3	88.3	88.2	88.2	88.1	87.9	87.8	87.6	87.3	87.1	86.8	86.5	86.1
95	86.9	86.9	86.9	86.9	86.9	86.9	86.9	86.9	86.9	86.8	86.8	86.8	86.7	86.6	86.5	86.4	86.3	86.1
98	86.3	86.3	86.3	86.3	86.3	86.3	86.3	86.3	86.3	86.3	86.3	86.3	86.3	86.2	86.2	86.2	86.2	86.1



Mean Annual Mass Removal Efficiencies (%) for 2.25-inches of Retention for Zone 4

NDCIA CN	Percent DCIA																	
	0-15	20	25	30	35	40	45	50	55	60	65	70	75	80	85	90	95	100
30	99.2	99.2	99.0	98.8	98.4	98.0	97.5	97.0	96.3	95.7	94.9	94.2	93.3	92.5	91.6	90.6	89.7	88.7
35	98.9	98.8	98.7	98.5	98.2	97.8	97.3	96.8	96.2	95.5	94.8	94.0	93.2	92.4	91.5	90.6	89.7	88.7
40	98.5	98.5	98.4	98.2	97.9	97.5	97.0	96.5	96.0	95.3	94.6	93.9	93.1	92.3	91.5	90.6	89.6	88.7
45	98.0	98.0	97.9	97.8	97.5	97.1	96.7	96.2	95.7	95.1	94.4	93.7	93.0	92.2	91.4	90.5	89.6	88.7
50	97.4	97.4	97.4	97.3	97.0	96.7	96.3	95.9	95.4	94.8	94.2	93.6	92.8	92.1	91.3	90.5	89.6	88.7
55	96.8	96.8	96.8	96.7	96.5	96.2	95.9	95.5	95.0	94.5	94.0	93.3	92.7	91.9	91.2	90.4	89.6	88.7
60	96.0	96.0	96.0	96.0	95.9	95.6	95.4	95.0	94.6	94.1	93.6	93.1	92.4	91.8	91.1	90.3	89.5	88.7
65	95.2	95.2	95.2	95.2	95.2	95.0	94.7	94.4	94.1	93.7	93.2	92.7	92.2	91.6	90.9	90.2	89.5	88.7
70	94.4	94.4	94.4	94.4	94.3	94.2	94.0	93.8	93.5	93.2	92.8	92.3	91.8	91.3	90.7	90.1	89.4	88.7
75	93.4	93.4	93.4	93.4	93.4	93.4	93.3	93.1	92.8	92.6	92.2	91.9	91.4	91.0	90.5	89.9	89.3	88.7
80	92.4	92.4	92.4	92.4	92.4	92.4	92.4	92.3	92.1	91.9	91.6	91.3	91.0	90.6	90.2	89.7	89.2	88.7
85	91.4	91.4	91.4	91.4	91.4	91.4	91.4	91.3	91.2	91.1	90.9	90.7	90.4	90.1	89.8	89.5	89.1	88.7
90	90.2	90.2	90.2	90.2	90.2	90.2	90.2	90.2	90.2	90.1	90.1	89.9	89.8	89.6	89.4	89.2	89.0	88.7
95	89.2	89.2	89.2	89.2	89.2	89.2	89.2	89.2	89.2	89.2	89.1	89.1	89.1	89.0	89.0	88.9	88.8	88.7
98	88.8	88.8	88.8	88.8	88.8	88.8	88.8	88.8	88.8	88.8	88.8	88.8	88.8	88.8	88.8	88.7	88.7	88.7

Mean Annual Mass Removal Efficiencies (%) for 2.50-inches of Retention for Zone 4

NDCIA CN	Percent DCIA																	
	0-15	20	25	30	35	40	45	50	55	60	65	70	75	80	85	90	95	100
30	99.4	99.3	99.2	99.0	98.8	98.5	98.1	97.6	97.1	96.6	95.9	95.3	94.6	93.9	93.1	92.4	91.5	90.7
35	99.1	99.1	99.0	98.8	98.6	98.3	97.9	97.4	96.9	96.4	95.8	95.2	94.5	93.8	93.1	92.3	91.5	90.7
40	98.7	98.7	98.7	98.5	98.3	98.0	97.6	97.2	96.8	96.2	95.7	95.1	94.4	93.8	93.0	92.3	91.5	90.7
45	98.3	98.3	98.3	98.2	98.0	97.7	97.4	97.0	96.5	96.0	95.5	94.9	94.3	93.7	93.0	92.2	91.5	90.7
50	97.9	97.9	97.9	97.8	97.6	97.3	97.0	96.7	96.3	95.8	95.3	94.7	94.2	93.5	92.9	92.2	91.4	90.7
55	97.3	97.3	97.3	97.3	97.1	96.9	96.6	96.3	95.9	95.5	95.0	94.5	94.0	93.4	92.8	92.1	91.4	90.7
60	96.7	96.7	96.7	96.7	96.6	96.4	96.2	95.9	95.5	95.2	94.8	94.3	93.8	93.2	92.7	92.0	91.4	90.7
65	96.0	96.0	96.0	96.0	95.9	95.8	95.6	95.4	95.1	94.8	94.4	94.0	93.5	93.0	92.5	91.9	91.3	90.7
70	95.3	95.3	95.3	95.3	95.3	95.2	95.0	94.8	94.6	94.3	94.0	93.7	93.3	92.8	92.3	91.8	91.3	90.7
75	94.5	94.5	94.5	94.5	94.5	94.4	94.3	94.2	94.0	93.8	93.5	93.2	92.9	92.5	92.1	91.7	91.2	90.7
80	93.6	93.6	93.6	93.6	93.6	93.6	93.6	93.5	93.4	93.2	93.0	92.8	92.5	92.2	91.9	91.5	91.1	90.7
85	92.7	92.7	92.7	92.7	92.7	92.7	92.7	92.7	92.6	92.5	92.4	92.2	92.0	91.8	91.6	91.3	91.0	90.7
90	91.8	91.8	91.8	91.8	91.8	91.8	91.8	91.8	91.8	91.8	91.7	91.6	91.5	91.4	91.2	91.1	90.9	90.7
95	91.0	91.0	91.0	91.0	91.0	91.0	91.0	91.0	91.0	91.0	91.0	91.0	90.9	90.9	90.9	90.8	90.8	90.7
98	90.7	90.7	90.7	90.7	90.7	90.7	90.7	90.7	90.7	90.7	90.7	90.7	90.7	90.7	90.7	90.7	90.7	90.7



Mean Annual Mass Removal Efficiencies (%) for 2.75-inches of Retention for Zone 4

NDCIA CN	Percent DCIA																	
	0-15	20	25	30	35	40	45	50	55	60	65	70	75	80	85	90	95	100
30	99.5	99.5	99.4	99.2	99.0	98.8	98.5	98.1	97.7	97.2	96.7	96.2	95.6	95.0	94.3	93.7	93.0	92.3
35	99.2	99.2	99.2	99.0	98.9	98.6	98.3	98.0	97.5	97.1	96.6	96.1	95.5	94.9	94.3	93.6	93.0	92.3
40	98.9	98.9	98.9	98.8	98.6	98.4	98.1	97.8	97.4	96.9	96.5	96.0	95.4	94.9	94.2	93.6	92.9	92.3
45	98.6	98.6	98.6	98.5	98.3	98.1	97.9	97.5	97.2	96.8	96.3	95.8	95.3	94.8	94.2	93.6	92.9	92.3
50	98.2	98.2	98.2	98.1	98.0	97.8	97.6	97.3	96.9	96.6	96.1	95.7	95.2	94.7	94.1	93.5	92.9	92.3
55	97.8	97.8	97.8	97.7	97.6	97.4	97.2	96.9	96.6	96.3	95.9	95.5	95.0	94.5	94.0	93.5	92.9	92.3
60	97.3	97.3	97.3	97.2	97.1	97.0	96.8	96.6	96.3	96.0	95.6	95.3	94.8	94.4	93.9	93.4	92.8	92.3
65	96.7	96.7	96.7	96.7	96.6	96.5	96.3	96.1	95.9	95.6	95.3	95.0	94.6	94.2	93.8	93.3	92.8	92.3
70	96.0	96.0	96.0	96.0	96.0	95.9	95.8	95.7	95.5	95.2	95.0	94.7	94.4	94.0	93.6	93.2	92.7	92.3
75	95.3	95.3	95.3	95.3	95.3	95.3	95.2	95.1	95.0	94.8	94.6	94.3	94.1	93.8	93.4	93.1	92.7	92.3
80	94.6	94.6	94.6	94.6	94.6	94.6	94.6	94.5	94.4	94.3	94.1	93.9	93.7	93.5	93.2	92.9	92.6	92.3
85	93.8	93.8	93.8	93.8	93.8	93.8	93.8	93.8	93.8	93.7	93.6	93.5	93.3	93.2	93.0	92.7	92.5	92.3
90	93.1	93.1	93.1	93.1	93.1	93.1	93.1	93.1	93.1	93.1	93.0	93.0	92.9	92.8	92.7	92.6	92.4	92.3
95	92.4	92.4	92.4	92.4	92.4	92.4	92.4	92.4	92.4	92.4	92.4	92.4	92.4	92.4	92.4	92.3	92.3	92.3
98	92.3	92.3	92.3	92.3	92.3	92.3	92.3	92.3	92.3	92.3	92.3	92.3	92.3	92.3	92.3	92.3	92.3	92.3

Mean Annual Mass Removal Efficiencies (%) for 3.00-inches of Retention for Zone 4

NDCIA CN	Percent DCIA																	
	0-15	20	25	30	35	40	45	50	55	60	65	70	75	80	85	90	95	100
30	99.6	99.6	99.5	99.4	99.2	99.0	98.8	98.5	98.1	97.7	97.3	96.9	96.4	95.9	95.3	94.7	94.1	93.5
35	99.4	99.4	99.3	99.2	99.1	98.9	98.6	98.3	98.0	97.6	97.2	96.8	96.3	95.8	95.3	94.7	94.1	93.5
40	99.1	99.1	99.1	99.0	98.9	98.7	98.5	98.2	97.9	97.5	97.1	96.7	96.2	95.7	95.2	94.7	94.1	93.5
45	98.8	98.8	98.8	98.7	98.6	98.5	98.3	98.0	97.7	97.3	97.0	96.6	96.1	95.6	95.1	94.6	94.1	93.5
50	98.5	98.5	98.5	98.4	98.3	98.2	98.0	97.7	97.5	97.1	96.8	96.4	96.0	95.5	95.1	94.6	94.0	93.5
55	98.1	98.1	98.1	98.1	98.0	97.9	97.7	97.4	97.2	96.9	96.6	96.2	95.9	95.4	95.0	94.5	94.0	93.5
60	97.7	97.7	97.7	97.7	97.6	97.5	97.3	97.1	96.9	96.6	96.4	96.0	95.7	95.3	94.9	94.5	94.0	93.5
65	97.2	97.2	97.2	97.2	97.1	97.0	96.9	96.7	96.6	96.3	96.1	95.8	95.5	95.1	94.8	94.4	93.9	93.5
70	96.6	96.6	96.6	96.6	96.6	96.5	96.5	96.3	96.2	96.0	95.8	95.5	95.2	94.9	94.6	94.3	93.9	93.5
75	96.0	96.0	96.0	96.0	96.0	96.0	95.9	95.9	95.7	95.6	95.4	95.2	95.0	94.7	94.5	94.2	93.8	93.5
80	95.4	95.4	95.4	95.4	95.4	95.4	95.4	95.3	95.3	95.1	95.0	94.9	94.7	94.5	94.3	94.0	93.8	93.5
85	94.8	94.8	94.8	94.8	94.8	94.8	94.8	94.7	94.7	94.6	94.6	94.5	94.4	94.2	94.1	93.9	93.7	93.5
90	94.1	94.1	94.1	94.1	94.1	94.1	94.1	94.1	94.1	94.1	94.1	94.0	94.0	93.9	93.8	93.7	93.6	93.5
95	93.6	93.6	93.6	93.6	93.6	93.6	93.6	93.6	93.6	93.6	93.6	93.6	93.6	93.6	93.6	93.6	93.5	93.5
98	93.5	93.5	93.5	93.5	93.5	93.5	93.5	93.5	93.5	93.5	93.5	93.5	93.5	93.5	93.5	93.5	93.5	93.5



**Mean Annual Mass Removal Efficiencies (%) for 3.25-inches of Retention for Zone 4**

NDCIA	Percent DCIA																		
	CN	0-15	20	25	30	35	40	45	50	55	60	65	70	75	80	85	90	95	100
30	99.6	99.6	99.6	99.5	99.4	99.2	99.0	98.8	98.5	98.2	97.8	97.4	97.0	96.5	96.1	95.6	95.0	94.5	
35	99.5	99.5	99.4	99.4	99.2	99.1	98.9	98.7	98.4	98.1	97.7	97.3	96.9	96.5	96.0	95.5	95.0	94.5	
40	99.3	99.3	99.2	99.2	99.1	98.9	98.7	98.5	98.2	97.9	97.6	97.2	96.8	96.4	96.0	95.5	95.0	94.5	
45	99.0	99.0	99.0	98.9	98.8	98.7	98.5	98.3	98.1	97.8	97.5	97.1	96.8	96.3	95.9	95.5	95.0	94.5	
50	98.7	98.7	98.7	98.7	98.6	98.5	98.3	98.1	97.9	97.6	97.3	97.0	96.6	96.3	95.9	95.4	95.0	94.5	
55	98.4	98.4	98.4	98.4	98.3	98.2	98.1	97.9	97.6	97.4	97.1	96.8	96.5	96.2	95.8	95.4	94.9	94.5	
60	98.0	98.0	98.0	98.0	98.0	97.9	97.7	97.6	97.4	97.2	96.9	96.7	96.4	96.0	95.7	95.3	94.9	94.5	
65	97.6	97.6	97.6	97.6	97.6	97.5	97.4	97.2	97.1	96.9	96.7	96.4	96.2	95.9	95.6	95.2	94.9	94.5	
70	97.1	97.1	97.1	97.1	97.1	97.1	97.0	96.9	96.7	96.6	96.4	96.2	96.0	95.7	95.4	95.1	94.8	94.5	
75	96.6	96.6	96.6	96.6	96.6	96.6	96.5	96.5	96.4	96.2	96.1	95.9	95.7	95.5	95.3	95.0	94.8	94.5	
80	96.1	96.1	96.1	96.1	96.1	96.1	96.0	96.0	95.9	95.9	95.8	95.6	95.5	95.3	95.1	94.9	94.7	94.5	
85	95.5	95.5	95.5	95.5	95.5	95.5	95.5	95.5	95.5	95.4	95.4	95.3	95.2	95.1	94.9	94.8	94.7	94.5	
90	95.0	95.0	95.0	95.0	95.0	95.0	95.0	95.0	95.0	95.0	94.9	94.9	94.9	94.8	94.7	94.7	94.6	94.5	
95	94.5	94.5	94.5	94.5	94.5	94.5	94.5	94.5	94.5	94.5	94.5	94.5	94.5	94.5	94.5	94.5	94.5	94.5	
98	94.5	94.5	94.5	94.5	94.5	94.5	94.5	94.5	94.5	94.5	94.5	94.5	94.5	94.5	94.5	94.5	94.5	94.5	94.5

**Mean Annual Mass Removal Efficiencies (%) for 3.50-inches of Retention for Zone 4**

NDCIA	Percent DCIA																		
	CN	0-15	20	25	30	35	40	45	50	55	60	65	70	75	80	85	90	95	100
30	99.7	99.7	99.7	99.6	99.5	99.4	99.2	99.0	98.8	98.5	98.2	97.8	97.5	97.1	96.7	96.2	95.8	95.3	
35	99.6	99.6	99.5	99.5	99.4	99.2	99.1	98.9	98.7	98.4	98.1	97.8	97.4	97.0	96.6	96.2	95.8	95.3	
40	99.4	99.4	99.4	99.3	99.2	99.1	98.9	98.8	98.5	98.3	98.0	97.7	97.3	97.0	96.6	96.2	95.7	95.3	
45	99.2	99.2	99.2	99.1	99.0	98.9	98.8	98.6	98.4	98.2	97.9	97.6	97.3	96.9	96.5	96.2	95.7	95.3	
50	98.9	98.9	98.9	98.9	98.8	98.7	98.6	98.4	98.2	98.0	97.7	97.5	97.2	96.8	96.5	96.1	95.7	95.3	
55	98.6	98.6	98.6	98.6	98.6	98.5	98.4	98.2	98.0	97.8	97.6	97.3	97.0	96.7	96.4	96.1	95.7	95.3	
60	98.3	98.3	98.3	98.3	98.3	98.2	98.1	98.0	97.8	97.6	97.4	97.2	96.9	96.6	96.3	96.0	95.7	95.3	
65	98.0	98.0	98.0	98.0	97.9	97.9	97.8	97.7	97.5	97.4	97.2	97.0	96.7	96.5	96.2	95.9	95.6	95.3	
70	97.6	97.6	97.6	97.6	97.5	97.5	97.4	97.3	97.2	97.1	96.9	96.8	96.6	96.3	96.1	95.9	95.6	95.3	
75	97.1	97.1	97.1	97.1	97.1	97.1	97.0	97.0	96.9	96.8	96.7	96.5	96.4	96.2	96.0	95.8	95.5	95.3	
80	96.6	96.6	96.6	96.6	96.6	96.6	96.6	96.6	96.5	96.4	96.4	96.3	96.1	96.0	95.8	95.7	95.5	95.3	
85	96.1	96.1	96.1	96.1	96.1	96.1	96.1	96.1	96.1	96.1	96.1	96.0	96.0	95.9	95.8	95.7	95.6	95.4	95.3
90	95.7	95.7	95.7	95.7	95.7	95.7	95.7	95.7	95.7	95.7	95.7	95.6	95.6	95.6	95.5	95.4	95.4	95.3	
95	95.3	95.3	95.3	95.3	95.3	95.3	95.3	95.3	95.3	95.3	95.3	95.3	95.3	95.3	95.3	95.3	95.3	95.3	95.3
98	95.3	95.3	95.3	95.3	95.3	95.3	95.3	95.3	95.3	95.3	95.3	95.3	95.3	95.3	95.3	95.3	95.3	95.3	95.3



**Mean Annual Mass Removal Efficiencies (%) for 3.75-inches of Retention for Zone 4**

NDCIA CN	Percent DCIA																	
	0-15	20	25	30	35	40	45	50	55	60	65	70	75	80	85	90	95	100
30	99.7	99.7	99.7	99.7	99.6	99.5	99.3	99.2	99.0	98.7	98.5	98.2	97.9	97.5	97.2	96.8	96.4	96.0
35	99.6	99.6	99.6	99.6	99.5	99.4	99.2	99.1	98.9	98.7	98.4	98.1	97.8	97.5	97.1	96.8	96.4	96.0
40	99.5	99.5	99.5	99.4	99.3	99.2	99.1	99.0	98.8	98.6	98.3	98.1	97.8	97.4	97.1	96.7	96.4	96.0
45	99.3	99.3	99.3	99.3	99.2	99.1	99.0	98.8	98.7	98.4	98.2	98.0	97.7	97.4	97.1	96.7	96.4	96.0
50	99.1	99.1	99.1	99.0	99.0	98.9	98.8	98.7	98.5	98.3	98.1	97.8	97.6	97.3	97.0	96.7	96.3	96.0
55	98.8	98.8	98.8	98.8	98.8	98.7	98.6	98.5	98.3	98.1	97.9	97.7	97.5	97.2	96.9	96.6	96.3	96.0
60	98.5	98.5	98.5	98.5	98.5	98.5	98.4	98.3	98.1	98.0	97.8	97.6	97.4	97.1	96.9	96.6	96.3	96.0
65	98.2	98.2	98.2	98.2	98.2	98.2	98.1	98.0	97.9	97.7	97.6	97.4	97.2	97.0	96.8	96.5	96.3	96.0
70	97.9	97.9	97.9	97.9	97.9	97.9	97.8	97.7	97.6	97.5	97.4	97.2	97.1	96.9	96.7	96.5	96.2	96.0
75	97.5	97.5	97.5	97.5	97.5	97.5	97.5	97.4	97.3	97.2	97.1	97.0	96.9	96.7	96.6	96.4	96.2	96.0
80	97.1	97.1	97.1	97.1	97.1	97.1	97.1	97.0	97.0	96.9	96.9	96.8	96.7	96.6	96.4	96.3	96.1	96.0
85	96.7	96.7	96.7	96.7	96.7	96.7	96.7	96.7	96.6	96.6	96.6	96.5	96.5	96.4	96.3	96.2	96.1	96.0
90	96.3	96.3	96.3	96.3	96.3	96.3	96.3	96.3	96.3	96.3	96.3	96.2	96.2	96.2	96.1	96.1	96.0	96.0
95	96.0	96.0	96.0	96.0	96.0	96.0	96.0	96.0	96.0	96.0	96.0	96.0	96.0	96.0	96.0	96.0	96.0	96.0
98	96.0	96.0	96.0	96.0	96.0	96.0	96.0	96.0	96.0	96.0	96.0	96.0	96.0	96.0	96.0	96.0	96.0	96.0

**Mean Annual Mass Removal Efficiencies (%) for 4.00-inches of Retention for Zone 4**

NDCIA CN	Percent DCIA																	
	0-15	20	25	30	35	40	45	50	55	60	65	70	75	80	85	90	95	100
30	99.8	99.8	99.8	99.8	99.7	99.6	99.5	99.3	99.1	99.0	98.7	98.5	98.2	97.9	97.6	97.3	96.9	96.5
35	99.7	99.7	99.7	99.7	99.6	99.5	99.4	99.2	99.1	98.9	98.7	98.4	98.2	97.9	97.6	97.2	96.9	96.5
40	99.6	99.6	99.6	99.5	99.5	99.4	99.3	99.1	99.0	98.8	98.6	98.4	98.1	97.8	97.5	97.2	96.9	96.5
45	99.4	99.4	99.4	99.4	99.3	99.2	99.1	99.0	98.9	98.7	98.5	98.3	98.0	97.8	97.5	97.2	96.9	96.5
50	99.2	99.2	99.2	99.2	99.1	99.1	99.0	98.9	98.7	98.6	98.4	98.2	97.9	97.7	97.4	97.1	96.8	96.5
55	99.0	99.0	99.0	99.0	98.9	98.9	98.8	98.7	98.6	98.4	98.2	98.1	97.8	97.6	97.4	97.1	96.8	96.5
60	98.8	98.8	98.8	98.8	98.7	98.7	98.6	98.5	98.4	98.3	98.1	97.9	97.7	97.5	97.3	97.1	96.8	96.5
65	98.5	98.5	98.5	98.5	98.5	98.4	98.4	98.3	98.2	98.1	97.9	97.8	97.6	97.4	97.2	97.0	96.8	96.5
70	98.2	98.2	98.2	98.2	98.2	98.2	98.1	98.1	98.0	97.9	97.7	97.6	97.5	97.3	97.1	96.9	96.7	96.5
75	97.9	97.9	97.9	97.9	97.9	97.8	97.8	97.8	97.7	97.6	97.5	97.4	97.3	97.2	97.0	96.9	96.7	96.5
80	97.5	97.5	97.5	97.5	97.5	97.5	97.5	97.4	97.4	97.3	97.3	97.2	97.1	97.0	96.9	96.8	96.7	96.5
85	97.1	97.1	97.1	97.1	97.1	97.1	97.1	97.1	97.1	97.1	97.0	97.0	96.9	96.9	96.8	96.7	96.6	96.5
90	96.8	96.8	96.8	96.8	96.8	96.8	96.8	96.8	96.8	96.8	96.8	96.7	96.7	96.7	96.7	96.6	96.6	96.5
95	96.5	96.5	96.5	96.5	96.5	96.5	96.5	96.5	96.5	96.5	96.5	96.5	96.5	96.5	96.5	96.5	96.5	96.5
98	96.5	96.5	96.5	96.5	96.5	96.5	96.5	96.5	96.5	96.5	96.5	96.5	96.5	96.5	96.5	96.5	96.5	96.5



Mean Annual Mass Removal Efficiencies (%) for 0.10-inches of Retention for Zone 5

NDCIA	Percent DCIA																	
	CN	0-15	20	25	30	35	40	45	50	55	60	65	70	75	80	85	90	95
30	46.9	39.3	33.7	29.5	26.3	23.7	21.5	19.8	18.2	16.9	15.8	14.8	14.0	13.2	12.5	11.9	11.3	10.8
35	45.6	38.5	33.2	29.2	26.0	23.5	21.4	19.7	18.2	16.9	15.8	14.8	13.9	13.2	12.5	11.9	11.3	10.8
40	43.9	37.5	32.5	28.7	25.7	23.2	21.2	19.5	18.1	16.8	15.7	14.8	13.9	13.2	12.5	11.9	11.3	10.8
45	42.1	36.3	31.7	28.2	25.3	22.9	21.0	19.4	17.9	16.7	15.6	14.7	13.9	13.1	12.5	11.9	11.3	10.8
50	40.0	35.0	30.8	27.5	24.8	22.6	20.7	19.2	17.8	16.6	15.6	14.6	13.8	13.1	12.4	11.8	11.3	10.8
55	37.8	33.5	29.8	26.8	24.3	22.2	20.4	18.9	17.6	16.4	15.4	14.6	13.8	13.1	12.4	11.8	11.3	10.8
60	35.3	31.8	28.6	25.9	23.6	21.7	20.1	18.6	17.4	16.3	15.3	14.5	13.7	13.0	12.4	11.8	11.3	10.8
65	32.7	30.0	27.3	24.9	22.9	21.1	19.6	18.3	17.1	16.1	15.2	14.3	13.6	12.9	12.3	11.8	11.3	10.8
70	29.9	27.9	25.8	23.8	22.0	20.4	19.1	17.9	16.8	15.8	15.0	14.2	13.5	12.9	12.3	11.8	11.3	10.8
75	27.0	25.6	24.0	22.4	21.0	19.6	18.4	17.4	16.4	15.5	14.7	14.0	13.4	12.8	12.2	11.7	11.2	10.8
80	23.8	23.1	22.0	20.8	19.7	18.6	17.6	16.7	15.9	15.1	14.4	13.8	13.2	12.6	12.1	11.7	11.2	10.8
85	20.5	20.2	19.6	18.9	18.1	17.3	16.6	15.9	15.2	14.5	14.0	13.4	12.9	12.4	12.0	11.6	11.2	10.8
90	17.1	17.1	16.9	16.5	16.1	15.6	15.2	14.7	14.2	13.8	13.3	12.9	12.5	12.1	11.8	11.4	11.1	10.8
95	13.8	13.8	13.8	13.7	13.6	13.4	13.2	13.0	12.8	12.6	12.3	12.1	11.9	11.7	11.4	11.2	11.0	10.8
98	12.3	12.2	12.2	12.1	12.1	12.0	11.9	11.8	11.7	11.6	11.5	11.4	11.3	11.2	11.1	11.0	10.9	10.8

Mean Annual Mass Removal Efficiencies (%) for 0.20-inches of Retention for Zone 5

NDCIA	Percent DCIA																	
	CN	0-15	20	25	30	35	40	45	50	55	60	65	70	75	80	85	90	95
30	67.8	60.2	53.7	48.4	43.9	40.2	37.0	34.4	32.0	30.0	28.2	26.6	25.2	23.9	22.8	21.8	20.8	20.0
35	65.9	58.9	52.9	47.8	43.5	39.9	36.8	34.2	31.9	29.9	28.1	26.6	25.2	23.9	22.8	21.7	20.8	20.0
40	63.6	57.4	51.8	47.0	42.9	39.5	36.5	33.9	31.7	29.7	28.0	26.5	25.1	23.9	22.7	21.7	20.8	20.0
45	60.9	55.6	50.6	46.1	42.3	39.0	36.1	33.6	31.5	29.6	27.9	26.4	25.0	23.8	22.7	21.7	20.8	20.0
50	57.9	53.6	49.1	45.1	41.5	38.4	35.7	33.3	31.2	29.4	27.7	26.3	24.9	23.7	22.7	21.7	20.8	20.0
55	54.7	51.3	47.5	43.9	40.6	37.7	35.1	32.9	30.9	29.1	27.5	26.1	24.8	23.7	22.6	21.7	20.8	20.0
60	51.3	48.8	45.6	42.5	39.5	36.9	34.5	32.4	30.5	28.8	27.3	25.9	24.7	23.6	22.6	21.6	20.7	20.0
65	47.7	46.0	43.5	40.8	38.3	35.9	33.7	31.8	30.0	28.5	27.0	25.7	24.5	23.5	22.5	21.6	20.7	20.0
70	43.9	43.0	41.1	39.0	36.8	34.8	32.8	31.1	29.5	28.0	26.7	25.5	24.3	23.3	22.4	21.5	20.7	20.0
75	39.9	39.7	38.4	36.8	35.1	33.4	31.7	30.2	28.8	27.5	26.3	25.1	24.1	23.1	22.2	21.4	20.7	20.0
80	35.9	35.9	35.3	34.3	33.0	31.7	30.3	29.1	27.9	26.7	25.7	24.7	23.8	22.9	22.1	21.3	20.6	20.0
85	31.8	31.8	31.7	31.2	30.4	29.5	28.6	27.6	26.7	25.8	24.9	24.1	23.3	22.5	21.8	21.2	20.5	20.0
90	27.7	27.7	27.7	27.6	27.2	26.8	26.2	25.6	25.0	24.4	23.8	23.2	22.6	22.0	21.5	21.0	20.4	20.0
95	23.5	23.5	23.5	23.5	23.4	23.3	23.1	22.9	22.7	22.4	22.1	21.8	21.5	21.2	20.9	20.6	20.3	20.0
98	21.6	21.6	21.6	21.5	21.4	21.4	21.3	21.2	21.1	21.0	20.9	20.7	20.6	20.5	20.4	20.2	20.1	20.0



**Mean Annual Mass Removal Efficiencies (%) for 0.30-inches of Retention for Zone 5**

NDCIA CN	Percent DCIA																	
	0-15	20	25	30	35	40	45	50	55	60	65	70	75	80	85	90	95	100
30	78.6	72.3	66.3	61.1	56.5	52.4	48.9	45.8	43.0	40.5	38.3	36.3	34.6	33.0	31.5	30.1	28.9	27.8
35	76.4	70.8	65.3	60.3	55.9	52.0	48.6	45.5	42.8	40.4	38.2	36.3	34.5	32.9	31.5	30.1	28.9	27.8
40	73.7	69.0	64.0	59.4	55.2	51.5	48.1	45.2	42.5	40.2	38.1	36.1	34.4	32.8	31.4	30.1	28.9	27.8
45	70.7	66.8	62.5	58.3	54.4	50.8	47.7	44.8	42.2	40.0	37.9	36.0	34.3	32.8	31.4	30.1	28.9	27.8
50	67.4	64.4	60.7	56.9	53.4	50.1	47.1	44.4	41.9	39.7	37.7	35.8	34.2	32.7	31.3	30.0	28.9	27.8
55	63.9	61.8	58.7	55.4	52.2	49.2	46.4	43.8	41.5	39.3	37.4	35.7	34.1	32.6	31.2	30.0	28.9	27.8
60	60.2	58.8	56.4	53.7	50.8	48.1	45.5	43.2	41.0	38.9	37.1	35.4	33.9	32.5	31.2	29.9	28.8	27.8
65	56.2	55.7	53.9	51.7	49.3	46.9	44.5	42.4	40.3	38.5	36.7	35.1	33.7	32.3	31.0	29.9	28.8	27.8
70	52.2	52.2	51.1	49.4	47.4	45.4	43.4	41.4	39.6	37.9	36.3	34.8	33.4	32.1	30.9	29.8	28.8	27.8
75	48.4	48.4	47.9	46.8	45.3	43.6	41.9	40.3	38.6	37.1	35.7	34.3	33.0	31.8	30.7	29.7	28.7	27.8
80	44.3	44.3	44.3	43.7	42.7	41.4	40.1	38.8	37.5	36.2	34.9	33.7	32.6	31.5	30.5	29.5	28.6	27.8
85	40.2	40.2	40.2	40.0	39.5	38.8	37.9	36.9	35.9	34.9	33.9	32.9	32.0	31.0	30.2	29.3	28.6	27.8
90	35.9	35.9	35.9	35.9	35.7	35.4	34.9	34.4	33.7	33.1	32.4	31.7	31.0	30.4	29.7	29.0	28.4	27.8
95	31.5	31.5	31.5	31.5	31.5	31.4	31.3	31.1	30.8	30.5	30.2	29.9	29.6	29.2	28.9	28.5	28.2	27.8
98	29.5	29.5	29.5	29.4	29.4	29.3	29.2	29.1	29.0	28.9	28.8	28.7	28.5	28.4	28.2	28.1	27.9	27.8

**Mean Annual Mass Removal Efficiencies (%) for 0.40-inches of Retention for Zone 5**

NDCIA CN	Percent DCIA																	
	0-15	20	25	30	35	40	45	50	55	60	65	70	75	80	85	90	95	100
30	84.4	79.8	74.8	70.0	65.6	61.6	58.0	54.7	51.8	49.1	46.7	44.5	42.5	40.7	39.0	37.4	36.0	34.7
35	82.1	78.2	73.6	69.1	64.9	61.1	57.6	54.4	51.6	49.0	46.6	44.4	42.4	40.6	38.9	37.4	36.0	34.7
40	79.4	76.2	72.2	68.0	64.1	60.5	57.1	54.1	51.3	48.7	46.4	44.3	42.3	40.6	38.9	37.4	36.0	34.7
45	76.4	73.9	70.5	66.7	63.1	59.7	56.5	53.6	50.9	48.5	46.2	44.1	42.2	40.5	38.8	37.3	36.0	34.7
50	73.0	71.4	68.5	65.2	61.9	58.8	55.8	53.1	50.5	48.1	45.9	43.9	42.1	40.4	38.8	37.3	35.9	34.7
55	69.5	68.6	66.3	63.5	60.6	57.7	55.0	52.4	50.0	47.7	45.6	43.7	41.9	40.2	38.7	37.2	35.9	34.7
60	65.7	65.5	63.8	61.6	59.0	56.5	54.0	51.6	49.4	47.2	45.2	43.4	41.7	40.1	38.6	37.2	35.9	34.7
65	62.2	62.2	61.1	59.4	57.3	55.1	52.9	50.7	48.6	46.6	44.8	43.0	41.4	39.9	38.4	37.1	35.8	34.7
70	58.6	58.6	58.1	56.8	55.2	53.4	51.5	49.6	47.7	45.9	44.2	42.6	41.1	39.6	38.3	37.0	35.8	34.7
75	54.7	54.7	54.7	54.0	52.8	51.4	49.9	48.2	46.6	45.0	43.5	42.1	40.6	39.3	38.1	36.9	35.7	34.7
80	50.8	50.8	50.8	50.6	49.9	49.0	47.8	46.5	45.2	43.9	42.6	41.3	40.1	38.9	37.8	36.7	35.7	34.7
85	46.7	46.7	46.7	46.7	46.5	45.9	45.2	44.3	43.4	42.4	41.4	40.4	39.3	38.3	37.4	36.4	35.5	34.7
90	42.6	42.6	42.6	42.6	42.5	42.3	41.9	41.5	40.9	40.3	39.6	38.9	38.2	37.5	36.8	36.1	35.4	34.7
95	38.3	38.3	38.3	38.3	38.3	38.2	38.1	38.0	37.8	37.5	37.2	36.9	36.6	36.2	35.8	35.5	35.1	34.7
98	36.3	36.3	36.3	36.3	36.2	36.1	36.1	36.0	35.9	35.8	35.7	35.5	35.4	35.3	35.1	35.0	34.8	34.7



Mean Annual Mass Removal Efficiencies (%) for 0.50-inches of Retention for Zone 5

NDCIA CN	Percent DCIA																	
	0-15	20	25	30	35	40	45	50	55	60	65	70	75	80	85	90	95	100
30	87.9	84.5	80.5	76.4	72.3	68.5	65.1	61.9	58.9	56.2	53.7	51.4	49.3	47.3	45.5	43.8	42.2	40.8
35	85.6	82.8	79.3	75.4	71.6	68.0	64.6	61.5	58.7	56.0	53.6	51.3	49.2	47.3	45.5	43.8	42.2	40.8
40	82.9	80.8	77.8	74.3	70.7	67.3	64.1	61.1	58.3	55.8	53.4	51.1	49.1	47.2	45.4	43.8	42.2	40.8
45	80.0	78.5	76.0	72.9	69.6	66.5	63.4	60.6	57.9	55.4	53.1	51.0	48.9	47.1	45.3	43.7	42.2	40.8
50	76.8	76.0	73.9	71.3	68.4	65.5	62.6	60.0	57.4	55.0	52.8	50.7	48.8	47.0	45.3	43.7	42.2	40.8
55	73.4	73.1	71.7	69.5	66.9	64.3	61.7	59.2	56.9	54.6	52.5	50.4	48.6	46.8	45.2	43.6	42.1	40.8
60	70.1	70.1	69.2	67.4	65.3	63.0	60.6	58.4	56.2	54.0	52.0	50.1	48.3	46.6	45.0	43.5	42.1	40.8
65	66.8	66.8	66.4	65.1	63.3	61.4	59.4	57.3	55.3	53.4	51.5	49.7	48.0	46.4	44.9	43.4	42.1	40.8
70	63.3	63.3	63.3	62.5	61.2	59.6	57.9	56.1	54.3	52.6	50.9	49.2	47.6	46.1	44.7	43.3	42.0	40.8
75	59.8	59.8	59.8	59.4	58.6	57.4	56.1	54.6	53.1	51.6	50.1	48.6	47.1	45.8	44.4	43.2	41.9	40.8
80	56.0	56.0	56.0	56.0	55.6	54.8	53.9	52.8	51.6	50.3	49.0	47.8	46.5	45.3	44.1	43.0	41.8	40.8
85	52.2	52.2	52.2	52.2	52.1	51.7	51.1	50.4	49.6	48.6	47.6	46.7	45.6	44.6	43.7	42.7	41.7	40.8
90	48.2	48.2	48.2	48.2	48.2	48.1	47.8	47.4	46.9	46.4	45.7	45.1	44.4	43.7	43.0	42.2	41.5	40.8
95	44.1	44.1	44.1	44.1	44.1	44.1	44.0	43.9	43.7	43.5	43.2	43.0	42.7	42.3	42.0	41.6	41.2	40.8
98	42.2	42.2	42.2	42.2	42.2	42.1	42.1	42.0	41.9	41.8	41.7	41.6	41.5	41.4	41.2	41.1	40.9	40.8

Mean Annual Mass Removal Efficiencies (%) for 0.60-inches of Retention for Zone 5

NDCIA CN	Percent DCIA																	
	0-15	20	25	30	35	40	45	50	55	60	65	70	75	80	85	90	95	100
30	90.2	87.7	84.5	81.0	77.5	74.0	70.7	67.6	64.7	62.1	59.6	57.2	55.1	53.1	51.2	49.4	47.7	46.2
35	88.0	86.0	83.2	80.1	76.7	73.4	70.2	67.2	64.4	61.8	59.4	57.1	55.0	53.0	51.1	49.4	47.7	46.2
40	85.4	84.0	81.7	78.8	75.8	72.7	69.6	66.8	64.1	61.5	59.2	56.9	54.9	52.9	51.1	49.3	47.7	46.2
45	82.6	81.7	79.9	77.4	74.6	71.8	68.9	66.2	63.6	61.2	58.9	56.7	54.7	52.8	51.0	49.3	47.7	46.2
50	79.6	79.3	77.8	75.8	73.3	70.7	68.1	65.5	63.1	60.8	58.6	56.5	54.5	52.6	50.9	49.2	47.7	46.2
55	76.5	76.5	75.6	73.9	71.8	69.5	67.1	64.7	62.5	60.3	58.2	56.2	54.3	52.5	50.8	49.2	47.6	46.2
60	73.5	73.5	73.1	71.8	70.1	68.0	65.9	63.8	61.7	59.7	57.7	55.8	54.0	52.3	50.6	49.1	47.6	46.2
65	70.3	70.3	70.3	69.5	68.1	66.4	64.6	62.7	60.8	59.0	57.1	55.4	53.7	52.0	50.5	49.0	47.5	46.2
70	67.2	67.2	67.2	66.8	65.9	64.5	63.0	61.4	59.7	58.1	56.4	54.8	53.2	51.7	50.2	48.8	47.5	46.2
75	63.9	63.9	63.9	63.8	63.2	62.3	61.1	59.8	58.4	57.0	55.6	54.1	52.7	51.3	50.0	48.7	47.4	46.2
80	60.5	60.5	60.5	60.5	60.2	59.6	58.8	57.9	56.8	55.7	54.5	53.2	52.0	50.8	49.6	48.4	47.3	46.2
85	56.8	56.8	56.8	56.8	56.7	56.5	56.0	55.4	54.7	53.9	53.0	52.0	51.1	50.1	49.1	48.1	47.1	46.2
90	53.0	53.0	53.0	53.0	53.0	52.9	52.7	52.4	52.1	51.6	51.0	50.4	49.7	49.1	48.4	47.6	46.9	46.2
95	49.1	49.1	49.1	49.1	49.1	49.1	49.1	49.0	48.9	48.7	48.5	48.2	47.9	47.6	47.3	47.0	46.6	46.2
98	47.4	47.4	47.4	47.4	47.4	47.3	47.3	47.2	47.2	47.1	47.0	46.9	46.8	46.7	46.6	46.5	46.3	46.2



Mean Annual Mass Removal Efficiencies (%) for 0.70-inches of Retention for Zone 5

NDCIA CN	Percent DCIA																	
	0-15	20	25	30	35	40	45	50	55	60	65	70	75	80	85	90	95	100
30	91.8	89.9	87.4	84.5	81.4	78.3	75.2	72.3	69.5	66.9	64.5	62.2	60.0	58.0	56.1	54.3	52.6	51.0
35	89.7	86.2	86.1	83.4	80.6	77.7	74.7	71.9	69.2	66.7	64.3	62.1	59.9	57.9	56.0	54.3	52.6	51.0
40	87.3	86.3	84.5	82.2	79.6	76.9	74.1	71.4	68.8	66.4	64.1	61.9	59.8	57.8	56.0	54.2	52.6	51.0
45	84.7	84.1	82.8	80.8	78.5	76.0	73.4	70.8	68.4	66.0	63.8	61.6	59.6	57.7	55.9	54.2	52.5	51.0
50	81.8	81.7	80.6	79.1	77.1	74.9	72.5	70.1	67.8	65.6	63.4	61.4	59.4	57.6	55.8	54.1	52.5	51.0
55	79.1	79.1	78.6	77.3	75.6	73.6	71.4	69.3	67.1	65.0	63.0	61.0	59.2	57.4	55.7	54.0	52.5	51.0
60	76.3	76.3	76.1	75.2	73.9	72.1	70.2	68.3	66.3	64.4	62.5	60.6	58.9	57.1	55.5	53.9	52.4	51.0
65	73.4	73.4	73.4	72.9	71.9	70.5	68.9	67.1	65.4	63.6	61.9	60.2	58.5	56.9	55.3	53.8	52.4	51.0
70	70.5	70.5	70.5	70.3	69.6	68.6	67.2	65.8	64.3	62.7	61.1	59.6	58.0	56.5	55.1	53.7	52.3	51.0
75	67.4	67.4	67.4	67.4	67.0	66.3	65.3	64.2	62.9	61.6	60.2	58.9	57.5	56.1	54.8	53.5	52.2	51.0
80	64.2	64.2	64.2	64.2	64.1	63.6	62.9	62.1	61.2	60.1	59.0	57.9	56.8	55.6	54.4	53.2	52.1	51.0
85	60.7	60.7	60.7	60.7	60.7	60.5	60.2	59.7	59.0	58.3	57.5	56.7	55.8	54.8	53.9	52.9	51.9	51.0
90	57.1	57.1	57.1	57.1	57.1	57.1	57.0	56.8	56.4	56.0	55.5	55.0	54.4	53.8	53.1	52.4	51.7	51.0
95	53.6	53.6	53.6	53.6	53.6	53.6	53.6	53.5	53.4	53.3	53.1	52.9	52.6	52.3	52.0	51.7	51.4	51.0
98	52.0	52.0	52.0	52.0	52.0	52.0	51.9	51.9	51.8	51.8	51.7	51.6	51.5	51.4	51.3	51.2	51.1	51.0

Mean Annual Mass Removal Efficiencies (%) for 0.80-inches of Retention for Zone 5

NDCIA CN	Percent DCIA																	
	0-15	20	25	30	35	40	45	50	55	60	65	70	75	80	85	90	95	100
30	93.0	91.5	89.5	87.1	84.4	81.7	78.9	76.2	73.6	71.1	68.7	66.4	64.3	62.3	60.4	58.6	56.9	55.3
35	91.0	89.9	88.2	86.0	83.6	81.0	78.4	75.8	73.2	70.8	68.5	66.3	64.2	62.2	60.3	58.6	56.9	55.3
40	88.8	88.1	86.7	84.8	82.6	80.2	77.8	75.3	72.8	70.5	68.2	66.1	64.0	62.1	60.3	58.5	56.8	55.3
45	86.4	86.0	84.9	83.4	81.4	79.3	77.0	74.7	72.3	70.1	67.9	65.8	63.9	62.0	60.2	58.5	56.8	55.3
50	83.7	83.7	83.0	81.8	80.1	78.2	76.1	73.9	71.7	69.6	67.5	65.6	63.6	61.8	60.1	58.4	56.8	55.3
55	81.2	81.2	80.9	80.0	78.6	76.9	75.0	73.0	71.0	69.0	67.1	65.2	63.4	61.6	59.9	58.3	56.7	55.3
60	78.5	78.5	78.5	77.9	76.9	75.5	73.8	72.0	70.2	68.4	66.6	64.8	63.0	61.4	59.8	58.2	56.7	55.3
65	75.9	75.9	75.9	75.7	74.9	73.8	72.4	70.9	69.2	67.6	65.9	64.3	62.7	61.1	59.6	58.1	56.6	55.3
70	73.1	73.1	73.1	73.1	72.7	71.9	70.8	69.5	68.1	66.6	65.1	63.7	62.2	60.7	59.3	57.9	56.6	55.3
75	70.4	70.4	70.4	70.4	70.2	69.6	68.8	67.8	66.7	65.5	64.2	62.9	61.6	60.3	59.0	57.7	56.5	55.3
80	67.4	67.4	67.4	67.4	67.4	67.1	66.5	65.8	64.9	64.0	63.0	61.9	60.8	59.7	58.6	57.5	56.4	55.3
85	64.2	64.2	64.2	64.2	64.2	64.1	63.8	63.3	62.8	62.2	61.4	60.6	59.8	59.0	58.0	57.1	56.2	55.3
90	60.8	60.8	60.8	60.8	60.8	60.8	60.7	60.5	60.3	59.9	59.5	59.0	58.5	57.9	57.3	56.6	55.9	55.3
95	57.5	57.5	57.5	57.5	57.5	57.5	57.5	57.4	57.4	57.3	57.1	57.0	56.7	56.5	56.2	55.9	55.6	55.3
98	56.1	56.1	56.1	56.1	56.1	56.1	56.0	56.0	56.0	55.9	55.9	55.8	55.7	55.7	55.6	55.5	55.4	55.3



**Mean Annual Mass Removal Efficiencies (%) for 0.90-inches of Retention for Zone 5**

NDCIA CN	Percent DCIA																	
	0-15	20	25	30	35	40	45	50	55	60	65	70	75	80	85	90	95	100
30	93.9	92.7	91.1	89.1	86.8	84.4	81.9	79.4	77.0	74.6	72.3	70.1	68.0	66.1	64.2	62.4	60.7	59.1
35	92.1	91.2	89.8	88.0	85.9	83.7	81.4	79.0	76.6	74.3	72.1	70.0	67.9	66.0	64.1	62.4	60.7	59.1
40	90.0	89.5	88.4	86.8	84.9	82.9	80.7	78.5	76.2	74.0	71.8	69.7	67.8	65.9	64.0	62.3	60.6	59.1
45	87.7	87.5	86.7	85.4	83.8	81.9	79.9	77.8	75.7	73.6	71.5	69.5	67.6	65.7	63.9	62.2	60.6	59.1
50	85.3	85.3	84.8	83.9	82.5	80.8	79.0	77.1	75.1	73.1	71.1	69.2	67.3	65.5	63.8	62.2	60.6	59.1
55	82.9	82.9	82.8	82.1	81.0	79.6	78.0	76.2	74.3	72.5	70.6	68.8	67.0	65.3	63.7	62.1	60.5	59.1
60	80.6	80.6	80.6	80.2	79.3	78.1	76.7	75.2	73.5	71.8	70.1	68.4	66.7	65.1	63.5	62.0	60.5	59.1
65	78.1	78.1	78.1	78.0	77.4	76.5	75.4	74.0	72.5	71.0	69.4	67.9	66.3	64.8	63.3	61.8	60.4	59.1
70	75.5	75.5	75.5	75.5	75.2	74.6	73.7	72.6	71.3	70.0	68.6	67.2	65.8	64.4	63.0	61.7	60.4	59.1
75	72.9	72.9	72.9	72.9	72.8	72.4	71.8	70.9	69.9	68.8	67.7	66.4	65.2	64.0	62.7	61.5	60.3	59.1
80	70.2	70.2	70.2	70.2	70.2	70.0	69.6	68.9	68.2	67.3	66.4	65.4	64.4	63.4	62.3	61.2	60.1	59.1
85	67.3	67.3	67.3	67.3	67.3	67.2	67.0	66.6	66.1	65.5	64.9	64.1	63.4	62.6	61.7	60.8	60.0	59.1
90	64.1	64.1	64.1	64.1	64.1	64.1	64.1	63.9	63.6	63.3	63.0	62.5	62.0	61.5	60.9	60.3	59.7	59.1
95	61.0	61.0	61.0	61.0	61.0	61.0	61.0	60.9	60.9	60.8	60.7	60.5	60.4	60.2	59.9	59.7	59.4	59.1
98	59.7	59.7	59.7	59.7	59.7	59.7	59.7	59.7	59.6	59.6	59.6	59.5	59.5	59.4	59.3	59.3	59.2	59.1

**Mean Annual Mass Removal Efficiencies (%) for 1.00-inches of Retention for Zone 5**

NDCIA CN	Percent DCIA																	
	0-15	20	25	30	35	40	45	50	55	60	65	70	75	80	85	90	95	100
30	94.6	93.7	92.3	90.6	88.7	86.5	84.3	82.1	79.8	77.6	75.4	73.3	71.3	69.4	67.5	65.8	64.1	62.5
35	92.9	92.3	91.1	89.6	87.8	85.9	83.8	81.6	79.5	77.3	75.2	73.1	71.2	69.3	67.5	65.7	64.0	62.5
40	91.0	90.7	89.7	88.4	86.8	85.0	83.1	81.1	79.0	77.0	74.9	72.9	71.0	69.1	67.4	65.7	64.0	62.5
45	88.8	88.8	88.1	87.1	85.7	84.1	82.3	80.4	78.5	76.5	74.6	72.7	70.8	69.0	67.3	65.6	64.0	62.5
50	86.8	86.8	86.4	85.5	84.4	83.0	81.4	79.7	77.9	76.0	74.2	72.3	70.5	68.8	67.1	65.5	64.0	62.5
55	84.5	84.5	84.4	83.9	83.0	81.8	80.3	78.8	77.1	75.4	73.7	72.0	70.3	68.6	67.0	65.4	63.9	62.5
60	82.2	82.2	82.2	82.0	81.3	80.3	79.2	77.8	76.3	74.7	73.1	71.5	69.9	68.3	66.8	65.3	63.9	62.5
65	79.9	79.9	79.9	79.9	79.5	78.7	77.8	76.6	75.3	73.9	72.4	71.0	69.5	68.0	66.6	65.2	63.8	62.5
70	77.6	77.6	77.6	77.6	77.4	76.9	76.2	75.3	74.2	72.9	71.6	70.3	69.0	67.7	66.3	65.0	63.7	62.5
75	75.1	75.1	75.1	75.1	75.1	74.8	74.3	73.6	72.7	71.7	70.7	69.5	68.4	67.2	66.0	64.8	63.6	62.5
80	72.6	72.6	72.6	72.6	72.6	72.5	72.2	71.7	71.0	70.3	69.4	68.5	67.6	66.6	65.6	64.5	63.5	62.5
85	69.9	69.9	69.9	69.9	69.9	69.9	69.8	69.5	69.0	68.5	67.9	67.2	66.5	65.8	65.0	64.2	63.3	62.5
90	67.1	67.1	67.1	67.1	67.1	67.1	67.0	66.9	66.7	66.4	66.1	65.7	65.2	64.7	64.2	63.6	63.1	62.5
95	64.1	64.1	64.1	64.1	64.1	64.1	64.1	64.1	64.1	64.0	63.9	63.8	63.6	63.4	63.2	63.0	62.7	62.5
98	62.9	62.9	62.9	62.9	62.9	62.9	62.9	62.9	62.9	62.9	62.9	62.8	62.8	62.7	62.7	62.6	62.5	62.5



**Mean Annual Mass Removal Efficiencies (%) for 1.25-inches of Retention for Zone 5**

NDCIA CN	Percent DCIA																	
	0-15	20	25	30	35	40	45	50	55	60	65	70	75	80	85	90	95	100
30	96.0	95.4	94.5	93.3	91.9	90.4	88.7	86.9	85.1	83.3	81.5	79.7	77.8	76.1	74.4	72.7	71.1	69.5
35	94.5	94.2	93.4	92.4	91.1	89.7	88.2	86.5	84.8	83.0	81.2	79.5	77.7	76.0	74.3	72.6	71.1	69.5
40	92.8	92.8	92.2	91.3	90.2	88.9	87.5	85.9	84.3	82.6	80.9	79.2	77.5	75.8	74.2	72.6	71.0	69.5
45	91.2	91.2	90.9	90.1	89.2	88.0	86.7	85.3	83.8	82.2	80.6	78.9	77.3	75.7	74.1	72.5	71.0	69.5
50	89.5	89.5	89.3	88.8	88.0	87.0	85.8	84.5	83.1	81.7	80.2	78.6	77.0	75.5	73.9	72.4	71.0	69.5
55	87.5	87.5	87.5	87.2	86.6	85.8	84.8	83.7	82.4	81.1	79.7	78.2	76.7	75.3	73.8	72.3	70.9	69.5
60	85.6	85.6	85.6	85.5	85.1	84.5	83.7	82.7	81.6	80.4	79.1	77.8	76.4	75.0	73.6	72.2	70.9	69.5
65	83.7	83.7	83.7	83.7	83.5	83.1	82.4	81.6	80.7	79.6	78.5	77.2	76.0	74.7	73.4	72.1	70.8	69.5
70	81.7	81.7	81.7	81.7	81.7	81.4	80.9	80.3	79.5	78.7	77.7	76.6	75.4	74.3	73.1	71.9	70.7	69.5
75	79.7	79.7	79.7	79.7	79.7	79.6	79.3	78.8	78.2	77.5	76.7	75.8	74.8	73.8	72.7	71.7	70.6	69.5
80	77.8	77.6	77.6	77.6	77.6	77.6	77.4	77.1	76.7	76.2	75.5	74.8	74.0	73.2	72.3	71.4	70.5	69.5
85	75.4	75.4	75.4	75.4	75.4	75.4	75.4	75.2	75.0	74.6	74.1	73.6	73.0	72.4	71.7	71.0	70.3	69.5
90	73.1	73.1	73.1	73.1	73.1	73.1	73.1	73.1	72.9	72.7	72.5	72.2	71.8	71.4	71.0	70.5	70.0	69.5
95	70.7	70.7	70.7	70.7	70.7	70.7	70.7	70.7	70.7	70.7	70.6	70.5	70.4	70.3	70.1	69.9	69.7	69.5
98	69.8	69.8	69.8	69.8	69.8	69.8	69.8	69.8	69.8	69.8	69.8	69.8	69.7	69.7	69.7	69.6	69.6	69.5

**Mean Annual Mass Removal Efficiencies (%) for 1.50-inches of Retention for Zone 5**

NDCIA CN	Percent DCIA																	
	0-15	20	25	30	35	40	45	50	55	60	65	70	75	80	85	90	95	100
30	97.0	96.5	95.9	95.0	93.9	92.8	91.5	90.2	88.7	87.2	85.7	84.1	82.6	81.1	79.5	78.0	76.5	75.1
35	95.6	95.4	95.0	94.2	93.2	92.2	91.0	89.7	88.3	86.9	85.4	83.9	82.4	81.0	79.5	78.0	76.5	75.1
40	94.2	94.2	93.9	93.3	92.4	91.5	90.4	89.2	87.9	86.5	85.1	83.7	82.3	80.8	79.4	77.9	76.5	75.1
45	92.8	92.8	92.7	92.2	91.5	90.6	89.6	88.6	87.4	86.1	84.8	83.4	82.0	80.6	79.2	77.8	76.4	75.1
50	91.4	91.4	91.4	91.0	90.4	89.7	88.8	87.9	86.8	85.6	84.4	83.1	81.8	80.4	79.1	77.7	76.4	75.1
55	89.8	89.8	89.8	89.6	89.2	88.6	87.9	87.1	86.1	85.0	83.9	82.7	81.5	80.2	78.9	77.6	76.3	75.1
60	88.2	88.2	88.2	88.1	87.9	87.4	86.9	86.2	85.3	84.4	83.3	82.2	81.1	79.9	78.7	77.5	76.3	75.1
65	86.5	86.5	86.5	86.5	86.4	86.1	85.7	85.1	84.4	83.6	82.7	81.7	80.7	79.6	78.5	77.4	76.2	75.1
70	84.8	84.8	84.8	84.8	84.8	84.7	84.4	83.9	83.4	82.7	81.9	81.1	80.2	79.3	78.2	77.2	76.1	75.1
75	83.1	83.1	83.1	83.1	83.1	83.1	82.9	82.6	82.2	81.6	81.0	80.4	79.6	78.8	77.9	77.0	76.0	75.1
80	81.4	81.4	81.4	81.4	81.4	81.4	81.3	81.1	80.8	80.4	80.0	79.5	78.9	78.2	77.5	76.7	75.9	75.1
85	79.5	79.5	79.5	79.5	79.5	79.5	79.5	79.5	79.3	79.1	78.8	78.4	78.0	77.5	76.9	76.3	75.7	75.1
90	77.7	77.7	77.7	77.7	77.7	77.7	77.7	77.7	77.7	77.6	77.4	77.2	76.9	76.6	76.3	75.9	75.5	75.1
95	75.9	75.9	75.9	75.9	75.9	75.9	75.9	75.9	75.9	75.9	75.9	75.8	75.7	75.6	75.5	75.4	75.2	75.1
98	75.2	75.2	75.2	75.2	75.2	75.2	75.2	75.2	75.2	75.2	75.2	75.2	75.2	75.2	75.2	75.1	75.1	75.1



Mean Annual Mass Removal Efficiencies (%) for 1.75-inches of Retention for Zone 5

NDCIA	Percent DCIA																		
	CN	0-15	20	25	30	35	40	45	50	55	60	65	70	75	80	85	90	95	100
30	97.7	97.4	96.8	96.2	95.4	94.4	93.5	92.4	91.2	90.0	88.7	87.4	86.1	84.8	83.4	82.1	80.8	79.4	
35	96.6	96.4	96.0	95.5	94.7	93.9	93.0	91.9	90.8	89.7	88.5	87.2	85.9	84.6	83.3	82.0	80.7	79.4	
40	95.2	95.2	95.0	94.6	94.0	93.2	92.4	91.4	90.4	89.3	88.2	87.0	85.7	84.5	83.2	82.0	80.7	79.4	
45	94.0	94.0	94.0	93.7	93.2	92.5	91.7	90.9	89.9	88.9	87.8	86.7	85.5	84.3	83.1	81.9	80.7	79.4	
50	92.8	92.8	92.8	92.6	92.2	91.7	91.0	90.2	89.4	88.4	87.4	86.4	85.3	84.1	83.0	81.8	80.6	79.4	
55	91.5	91.5	91.5	91.5	91.2	90.7	90.2	89.5	88.7	87.9	87.0	86.0	85.0	83.9	82.8	81.7	80.6	79.4	
60	90.2	90.2	90.2	90.2	90.0	89.6	89.2	88.6	88.0	87.3	86.4	85.6	84.6	83.6	82.6	81.6	80.5	79.4	
65	88.7	88.7	88.7	88.7	88.7	88.5	88.1	87.7	87.2	86.6	85.8	85.1	84.2	83.3	82.4	81.4	80.5	79.4	
70	87.2	87.2	87.2	87.2	87.2	87.2	87.0	86.6	86.2	85.7	85.1	84.5	83.7	83.0	82.1	81.3	80.4	79.4	
75	85.8	85.8	85.8	85.8	85.8	85.8	85.7	85.5	85.2	84.8	84.3	83.8	83.2	82.5	81.8	81.1	80.3	79.4	
80	84.3	84.3	84.3	84.3	84.3	84.3	84.3	84.2	84.0	83.7	83.4	83.0	82.5	82.0	81.4	80.8	80.1	79.4	
85	82.8	82.8	82.8	82.8	82.8	82.8	82.8	82.8	82.7	82.5	82.3	82.1	81.7	81.4	81.0	80.5	80.0	79.4	
90	81.3	81.3	81.3	81.3	81.3	81.3	81.3	81.3	81.3	81.2	81.1	81.0	80.9	80.6	80.4	80.1	79.8	79.4	
95	79.9	79.9	79.9	79.9	79.9	79.9	79.9	79.9	79.9	79.9	79.9	79.9	79.9	79.8	79.8	79.7	79.6	79.4	
98	79.5	79.5	79.5	79.5	79.5	79.5	79.5	79.5	79.5	79.5	79.5	79.5	79.5	79.5	79.5	79.5	79.5	79.4	

Mean Annual Mass Removal Efficiencies (%) for 2.00-inches of Retention for Zone 5

NDCIA	Percent DCIA																		
	CN	0-15	20	25	30	35	40	45	50	55	60	65	70	75	80	85	90	95	100
30	98.3	98.0	97.5	97.0	96.4	95.6	94.8	93.9	93.0	92.0	91.0	89.9	88.7	87.6	86.4	85.2	84.0	82.9	
35	97.3	97.1	96.8	96.3	95.8	95.1	94.4	93.6	92.7	91.7	90.7	89.7	88.6	87.4	86.3	85.2	84.0	82.9	
40	96.1	96.1	95.9	95.6	95.2	94.5	93.8	93.1	92.3	91.4	90.4	89.4	88.4	87.3	86.2	85.1	84.0	82.9	
45	95.0	95.0	94.9	94.8	94.4	93.9	93.3	92.6	91.8	91.0	90.1	89.2	88.2	87.1	86.1	85.0	83.9	82.9	
50	93.9	93.9	93.9	93.8	93.6	93.1	92.6	92.0	91.3	90.5	89.7	88.8	87.9	87.0	86.0	84.9	83.9	82.9	
55	92.8	92.8	92.8	92.8	92.6	92.3	91.8	91.3	90.7	90.0	89.3	88.5	87.6	86.7	85.8	84.8	83.9	82.9	
60	91.7	91.7	91.7	91.7	91.6	91.3	91.0	90.6	90.0	89.4	88.8	88.1	87.3	86.5	85.6	84.7	83.8	82.9	
65	90.5	90.5	90.5	90.5	90.5	90.3	90.0	89.7	89.3	88.8	88.2	87.6	86.9	86.2	85.4	84.6	83.7	82.9	
70	89.2	89.2	89.2	89.2	89.2	89.1	89.0	88.8	88.4	88.0	87.6	87.1	86.5	85.8	85.1	84.4	83.7	82.9	
75	87.9	87.9	87.9	87.9	87.9	87.9	87.9	87.7	87.5	87.2	86.9	86.4	86.0	85.4	84.8	84.2	83.6	82.9	
80	86.7	86.7	86.7	86.7	86.7	86.7	86.7	86.6	86.5	86.3	86.1	85.7	85.4	84.9	84.5	84.0	83.4	82.9	
85	85.4	85.4	85.4	85.4	85.4	85.4	85.4	85.4	85.4	85.3	85.1	84.9	84.7	84.4	84.1	83.7	83.3	82.9	
90	84.2	84.2	84.2	84.2	84.2	84.2	84.2	84.2	84.2	84.2	84.1	84.0	83.9	83.8	83.6	83.4	83.1	82.9	
95	83.1	83.1	83.1	83.1	83.1	83.1	83.1	83.1	83.1	83.1	83.1	83.1	83.1	83.1	83.1	83.0	82.9	82.9	
98	82.9	82.9	82.9	82.9	82.9	82.9	82.9	82.9	82.9	82.9	82.9	82.9	82.9	82.9	82.9	82.9	82.9	82.9	82.9



**Mean Annual Mass Removal Efficiencies (%) for 2.25-inches of Retention for Zone 5**

NDCIA CN	Percent DCIA																	
	0-15	20	25	30	35	40	45	50	55	60	65	70	75	80	85	90	95	100
30	98.6	98.5	98.1	97.6	97.1	96.5	95.9	95.1	94.3	93.5	92.6	91.7	90.7	89.7	88.7	87.7	86.6	85.6
35	97.8	97.7	97.5	97.0	96.6	96.1	95.4	94.7	94.0	93.2	92.4	91.5	90.6	89.6	88.6	87.6	86.6	85.6
40	96.9	96.8	96.6	96.3	96.0	95.5	95.0	94.3	93.6	92.9	92.1	91.3	90.4	89.5	88.5	87.6	86.6	85.6
45	95.8	95.8	95.7	95.6	95.3	94.9	94.4	93.9	93.2	92.6	91.8	91.0	90.2	89.3	88.4	87.5	86.5	85.6
50	94.8	94.8	94.8	94.8	94.6	94.3	93.8	93.3	92.8	92.1	91.5	90.7	90.0	89.1	88.3	87.4	86.5	85.6
55	93.9	93.9	93.9	93.9	93.6	93.5	93.2	92.7	92.2	91.7	91.1	90.4	89.7	88.9	88.1	87.3	86.5	85.6
60	92.9	92.9	92.9	92.9	92.9	92.7	92.4	92.0	91.6	91.1	90.6	90.0	89.4	88.7	88.0	87.2	86.4	85.6
65	91.9	91.9	91.9	91.9	91.9	91.8	91.6	91.3	90.9	90.6	90.1	89.6	89.0	88.4	87.8	87.1	86.3	85.6
70	90.8	90.8	90.8	90.8	90.8	90.8	90.6	90.4	90.2	89.9	89.5	89.1	88.6	88.1	87.5	86.9	86.3	85.6
75	89.7	89.7	89.7	89.7	89.7	89.7	89.6	89.6	89.4	89.1	88.9	88.5	88.2	87.7	87.2	86.7	86.2	85.6
80	88.6	88.6	88.6	88.6	88.6	88.6	88.6	88.6	88.5	88.3	88.1	87.9	87.6	87.3	86.9	86.5	86.1	85.6
85	87.5	87.5	87.5	87.5	87.5	87.5	87.5	87.5	87.5	87.5	87.4	87.2	87.0	86.8	86.5	86.3	85.9	85.6
90	86.5	86.5	86.5	86.5	86.5	86.5	86.5	86.5	86.5	86.5	86.5	86.4	86.3	86.1	86.0	85.8	85.6	85.6
95	85.7	85.7	85.7	85.7	85.7	85.7	85.7	85.7	85.7	85.7	85.7	85.7	85.7	85.7	85.7	85.6	85.6	85.6
98	85.6	85.6	85.6	85.6	85.6	85.6	85.6	85.6	85.6	85.6	85.6	85.6	85.6	85.6	85.6	85.6	85.6	85.6

**Mean Annual Mass Removal Efficiencies (%) for 2.50-inches of Retention for Zone 5**

NDCIA CN	Percent DCIA																	
	0-15	20	25	30	35	40	45	50	55	60	65	70	75	80	85	90	95	100
30	98.9	98.8	98.6	98.2	97.7	97.2	96.7	96.0	95.3	94.6	93.9	93.1	92.3	91.4	90.6	89.6	88.7	87.8
35	98.3	98.2	98.0	97.6	97.2	96.8	96.3	95.7	95.0	94.4	93.7	92.9	92.1	91.3	90.5	89.6	88.7	87.8
40	97.4	97.4	97.3	97.0	96.7	96.3	95.9	95.3	94.7	94.1	93.4	92.7	92.0	91.2	90.4	89.5	88.7	87.8
45	96.5	96.5	96.5	96.3	96.0	95.8	95.4	94.9	94.3	93.8	93.2	92.5	91.8	91.0	90.3	89.5	88.6	87.8
50	95.6	95.6	95.6	95.5	95.4	95.2	94.8	94.4	93.9	93.4	92.8	92.2	91.6	90.9	90.1	89.4	88.6	87.8
55	94.7	94.7	94.7	94.7	94.7	94.5	94.2	93.9	93.4	93.0	92.5	91.9	91.3	90.7	90.0	89.3	88.5	87.8
60	93.9	93.9	93.9	93.9	93.9	93.8	93.5	93.2	92.9	92.5	92.0	91.6	91.0	90.4	89.8	89.2	88.5	87.8
65	93.1	93.1	93.1	93.1	93.1	93.0	92.8	92.6	92.3	92.0	91.6	91.2	90.7	90.2	89.6	89.1	88.4	87.8
70	92.1	92.1	92.1	92.1	92.1	92.1	92.0	91.8	91.6	91.4	91.1	90.7	90.3	89.9	89.4	88.9	88.4	87.8
75	91.1	91.1	91.1	91.1	91.1	91.1	91.1	91.0	90.9	90.7	90.5	90.2	89.9	89.5	89.2	88.7	88.3	87.8
80	90.2	90.2	90.2	90.2	90.2	90.2	90.2	90.2	90.1	90.0	89.8	89.7	89.4	89.2	88.9	88.5	88.2	87.8
85	89.3	89.3	89.3	89.3	89.3	89.3	89.3	89.3	89.3	89.2	89.2	89.1	88.9	88.8	88.6	88.3	88.1	87.8
90	88.4	88.4	88.4	88.4	88.4	88.4	88.4	88.4	88.4	88.4	88.4	88.4	88.4	88.3	88.2	88.1	87.9	87.8
95	87.8	87.8	87.8	87.8	87.8	87.8	87.8	87.8	87.8	87.8	87.8	87.8	87.8	87.8	87.8	87.8	87.8	87.8
98	87.8	87.8	87.8	87.8	87.8	87.8	87.8	87.8	87.8	87.8	87.8	87.8	87.8	87.8	87.8	87.8	87.8	87.8



**Mean Annual Mass Removal Efficiencies (%) for 2.75-inches of Retention for Zone 5**

NDCIA CN	Percent DCIA																	
	0-15	20	25	30	35	40	45	50	55	60	65	70	75	80	85	90	95	100
30	99.1	99.1	98.9	98.6	98.2	97.8	97.3	96.7	96.2	95.5	94.9	94.2	93.5	92.8	92.0	91.2	90.4	89.6
35	98.6	98.6	98.4	98.1	97.7	97.4	96.9	96.4	95.9	95.3	94.7	94.1	93.4	92.7	91.9	91.2	90.4	89.6
40	97.9	97.9	97.6	97.5	97.2	96.9	96.5	96.1	95.6	95.0	94.5	93.9	93.2	92.5	91.8	91.1	90.3	89.6
45	97.1	97.1	97.1	96.9	96.6	96.4	96.1	95.7	95.2	94.7	94.2	93.6	93.0	92.4	91.7	91.0	90.3	89.6
50	96.3	96.3	96.3	96.2	96.0	95.8	95.6	95.3	94.9	94.4	93.9	93.4	92.8	92.2	91.6	91.0	90.3	89.6
55	95.4	95.4	95.4	95.4	95.4	95.3	95.1	94.8	94.4	94.0	93.6	93.1	92.6	92.1	91.5	90.9	90.2	89.6
60	94.7	94.7	94.7	94.7	94.7	94.6	94.5	94.2	93.9	93.6	93.2	92.8	92.3	91.8	91.3	90.8	90.2	89.6
65	94.0	94.0	94.0	94.0	94.0	93.9	93.8	93.6	93.4	93.1	92.8	92.4	92.0	91.6	91.1	90.6	90.1	89.6
70	93.2	93.2	93.2	93.2	93.2	93.2	93.1	93.0	92.8	92.6	92.3	92.0	91.7	91.3	90.9	90.5	90.1	89.6
75	92.4	92.4	92.4	92.4	92.4	92.4	92.3	92.2	92.1	92.0	91.8	91.6	91.3	91.0	90.7	90.4	90.0	89.6
80	91.5	91.5	91.5	91.5	91.5	91.5	91.5	91.5	91.4	91.4	91.3	91.1	90.9	90.7	90.5	90.2	89.9	89.6
85	90.7	90.7	90.7	90.7	90.7	90.7	90.7	90.7	90.7	90.7	90.7	90.6	90.5	90.3	90.2	90.0	89.8	89.6
90	90.0	90.0	90.0	90.0	90.0	90.0	90.0	90.0	90.0	90.0	90.0	90.0	90.0	89.9	89.9	89.8	89.7	89.6
95	89.6	89.6	89.6	89.6	89.6	89.6	89.6	89.6	89.6	89.6	89.6	89.6	89.6	89.6	89.6	89.6	89.6	89.6
98	89.6	89.6	89.6	89.6	89.6	89.6	89.6	89.6	89.6	89.6	89.6	89.6	89.6	89.6	89.6	89.6	89.6	89.6

**Mean Annual Mass Removal Efficiencies (%) for 3.00-inches of Retention for Zone 5**

NDCIA CN	Percent DCIA																	
	0-15	20	25	30	35	40	45	50	55	60	65	70	75	80	85	90	95	100
30	99.3	99.2	99.1	98.9	98.6	98.2	97.8	97.3	96.8	96.3	95.7	95.1	94.5	93.8	93.2	92.5	91.8	91.0
35	98.9	98.8	98.7	98.5	98.2	97.8	97.5	97.0	96.6	96.1	95.5	94.9	94.4	93.7	93.1	92.4	91.7	91.0
40	98.3	98.3	98.2	98.0	97.7	97.4	97.1	96.7	96.3	95.8	95.3	94.8	94.2	93.6	93.0	92.4	91.7	91.0
45	97.6	97.6	97.6	97.4	97.2	96.9	96.7	96.4	96.0	95.5	95.1	94.6	94.0	93.5	92.9	92.3	91.7	91.0
50	96.9	96.9	96.9	96.8	96.6	96.4	96.2	96.0	95.6	95.2	94.8	94.3	93.9	93.4	92.8	92.2	91.6	91.0
55	96.1	96.1	96.1	96.1	96.0	95.9	95.7	95.5	95.2	94.9	94.5	94.1	93.6	93.2	92.7	92.2	91.6	91.0
60	95.4	95.4	95.4	95.4	95.4	95.3	95.2	95.0	94.8	94.5	94.1	93.8	93.4	93.0	92.5	92.1	91.6	91.0
65	94.7	94.7	94.7	94.7	94.7	94.7	94.6	94.5	94.3	94.0	93.8	93.5	93.1	92.8	92.4	91.9	91.5	91.0
70	94.1	94.1	94.1	94.1	94.1	94.1	94.0	93.9	93.8	93.6	93.3	93.1	92.8	92.5	92.2	91.8	91.4	91.0
75	93.3	93.3	93.3	93.3	93.3	93.3	93.3	93.3	93.2	93.0	92.9	92.7	92.5	92.3	92.0	91.7	91.4	91.0
80	92.6	92.6	92.6	92.6	92.6	92.6	92.6	92.6	92.5	92.5	92.4	92.3	92.1	92.0	91.8	91.5	91.3	91.0
85	91.9	91.9	91.9	91.9	91.9	91.9	91.9	91.9	91.9	91.9	91.9	91.8	91.7	91.6	91.5	91.4	91.2	91.0
90	91.4	91.4	91.4	91.4	91.4	91.4	91.4	91.4	91.4	91.4	91.4	91.4	91.3	91.3	91.3	91.2	91.1	91.0
95	91.0	91.0	91.0	91.0	91.0	91.0	91.0	91.0	91.0	91.0	91.0	91.0	91.0	91.0	91.0	91.0	91.0	91.0
98	91.0	91.0	91.0	91.0	91.0	91.0	91.0	91.0	91.0	91.0	91.0	91.0	91.0	91.0	91.0	91.0	91.0	91.0



**Mean Annual Mass Removal Efficiencies (%) for 3.25-inches of Retention for Zone 5**

NDCIA CN	Percent DCIA																	
	0-15	20	25	30	35	40	45	50	55	60	65	70	75	80	85	90	95	100
30	99.5	99.4	99.3	99.1	98.9	98.6	98.2	97.8	97.4	96.9	96.4	95.8	95.3	94.7	94.1	93.5	92.9	92.2
35	99.1	99.0	99.0	98.8	98.5	98.2	97.9	97.5	97.1	96.7	96.2	95.7	95.2	94.6	94.1	93.5	92.9	92.2
40	98.6	98.6	98.5	98.4	98.1	97.8	97.5	97.2	96.9	96.5	96.0	95.5	95.0	94.5	94.0	93.4	92.8	92.2
45	98.0	98.0	98.0	97.8	97.7	97.4	97.1	96.9	96.6	96.2	95.8	95.3	94.9	94.4	93.9	93.4	92.8	92.2
50	97.4	97.4	97.4	97.3	97.1	96.9	96.7	96.5	96.3	95.9	95.5	95.1	94.7	94.3	93.8	93.3	92.8	92.2
55	96.7	96.7	96.7	96.7	96.6	96.4	96.3	96.1	95.9	95.6	95.3	94.9	94.5	94.1	93.7	93.2	92.7	92.2
60	96.0	96.0	96.0	96.0	96.0	95.9	95.8	95.7	95.5	95.2	94.9	94.6	94.3	93.9	93.5	93.1	92.7	92.2
65	95.4	95.4	95.4	95.4	95.4	95.4	95.3	95.2	95.0	94.8	94.6	94.3	94.0	93.7	93.4	93.0	92.6	92.2
70	94.8	94.8	94.8	94.8	94.8	94.8	94.8	94.7	94.6	94.4	94.2	94.0	93.8	93.5	93.2	92.9	92.6	92.2
75	94.2	94.2	94.2	94.2	94.2	94.2	94.2	94.1	94.1	94.0	93.8	93.6	93.5	93.3	93.0	92.8	92.5	92.2
80	93.6	93.6	93.6	93.6	93.6	93.6	93.6	93.6	93.5	93.4	93.4	93.3	93.2	93.0	92.8	92.6	92.4	92.2
85	92.9	92.9	92.9	92.9	92.9	92.9	92.9	92.9	92.9	92.9	92.9	92.9	92.8	92.7	92.6	92.5	92.4	92.2
90	92.5	92.5	92.5	92.5	92.5	92.5	92.5	92.5	92.5	92.5	92.5	92.5	92.4	92.4	92.4	92.3	92.3	92.2
95	92.2	92.2	92.2	92.2	92.2	92.2	92.2	92.2	92.2	92.2	92.2	92.2	92.2	92.2	92.2	92.2	92.2	92.2
98	92.2	92.2	92.2	92.2	92.2	92.2	92.2	92.2	92.2	92.2	92.2	92.2	92.2	92.2	92.2	92.2	92.2	92.2

**Mean Annual Mass Removal Efficiencies (%) for 3.50-inches of Retention for Zone 5**

NDCIA CN	Percent DCIA																	
	0-15	20	25	30	35	40	45	50	55	60	65	70	75	80	85	90	95	100
30	99.6	99.5	99.4	99.3	99.1	98.9	98.5	98.2	97.8	97.4	96.9	96.5	96.0	95.4	94.9	94.4	93.8	93.2
35	99.2	99.2	99.1	99.0	98.8	98.6	98.3	97.9	97.6	97.2	96.8	96.3	95.8	95.4	94.9	94.3	93.8	93.2
40	98.8	98.8	98.8	98.7	98.5	98.2	97.9	97.6	97.3	97.0	96.6	96.2	95.7	95.3	94.8	94.3	93.8	93.2
45	98.4	98.4	98.3	98.2	98.0	97.8	97.6	97.3	97.1	96.8	96.4	96.0	95.6	95.1	94.7	94.2	93.7	93.2
50	97.8	97.8	97.8	97.7	97.6	97.4	97.2	97.0	96.7	96.5	96.1	95.8	95.4	95.0	94.6	94.2	93.7	93.2
55	97.2	97.2	97.2	97.2	97.1	96.9	96.8	96.6	96.4	96.2	95.9	95.6	95.2	94.9	94.5	94.1	93.7	93.2
60	96.5	96.5	96.5	96.5	96.5	96.4	96.3	96.2	96.1	95.9	95.6	95.3	95.0	94.7	94.4	94.0	93.6	93.2
65	95.9	95.9	95.9	95.9	95.9	95.9	95.9	95.8	95.7	95.5	95.3	95.1	94.8	94.5	94.2	93.9	93.6	93.2
70	95.4	95.4	95.4	95.4	95.4	95.4	95.4	95.4	95.3	95.1	95.0	94.8	94.5	94.3	94.1	93.8	93.5	93.2
75	94.9	94.9	94.9	94.9	94.9	94.9	94.9	94.9	94.8	94.7	94.6	94.4	94.3	94.1	93.9	93.7	93.5	93.2
80	94.3	94.3	94.3	94.3	94.3	94.3	94.3	94.3	94.3	94.3	94.2	94.1	94.0	93.9	93.7	93.6	93.4	93.2
85	93.8	93.8	93.8	93.8	93.8	93.8	93.8	93.8	93.8	93.8	93.8	93.7	93.7	93.6	93.6	93.5	93.3	93.2
90	93.4	93.4	93.4	93.4	93.4	93.4	93.4	93.4	93.4	93.4	93.4	93.4	93.4	93.4	93.4	93.3	93.3	93.2
95	93.2	93.2	93.2	93.2	93.2	93.2	93.2	93.2	93.2	93.2	93.2	93.2	93.2	93.2	93.2	93.2	93.2	93.2
98	93.2	93.2	93.2	93.2	93.2	93.2	93.2	93.2	93.2	93.2	93.2	93.2	93.2	93.2	93.2	93.2	93.2	93.2



**Mean Annual Mass Removal Efficiencies (%) for 3.75-inches of Retention for Zone 5**

NDCIA CN	Percent DCIA																	
	0-15	20	25	30	35	40	45	50	55	60	65	70	75	80	85	90	95	100
30	99.7	99.6	99.5	99.4	99.3	99.1	98.8	98.5	98.2	97.8	97.4	97.0	96.5	96.1	95.6	95.1	94.6	94.1
35	99.4	99.3	99.3	99.2	99.0	98.8	98.6	98.3	98.0	97.6	97.3	96.9	96.4	96.0	95.5	95.1	94.6	94.1
40	99.0	99.0	99.0	98.9	98.7	98.5	98.3	98.0	97.7	97.4	97.1	96.7	96.3	95.9	95.4	95.0	94.5	94.1
45	98.6	98.6	98.6	98.5	98.4	98.2	98.0	97.7	97.5	97.2	96.9	96.5	96.2	95.8	95.4	95.0	94.5	94.1
50	98.2	98.2	98.2	98.1	98.0	97.8	97.6	97.4	97.2	96.9	96.7	96.4	96.0	95.7	95.3	94.9	94.5	94.1
55	97.6	97.6	97.6	97.6	97.5	97.4	97.2	97.0	96.9	96.7	96.4	96.2	95.9	95.5	95.2	94.8	94.5	94.1
60	97.0	97.0	97.0	97.0	97.0	96.9	96.8	96.7	96.6	96.4	96.2	95.9	95.7	95.4	95.1	94.7	94.4	94.1
65	96.5	96.5	96.5	96.5	96.4	96.4	96.4	96.3	96.2	96.1	95.9	95.7	95.5	95.2	94.9	94.7	94.4	94.1
70	95.9	95.9	95.9	95.9	95.9	95.9	95.9	95.9	95.9	95.7	95.6	95.4	95.2	95.0	94.8	94.6	94.3	94.1
75	95.5	95.5	95.5	95.5	95.5	95.5	95.5	95.5	95.4	95.4	95.3	95.1	95.0	94.8	94.7	94.5	94.3	94.1
80	95.0	95.0	95.0	95.0	95.0	95.0	95.0	95.0	95.0	95.0	94.9	94.8	94.7	94.6	94.5	94.4	94.2	94.1
85	94.6	94.6	94.6	94.6	94.6	94.6	94.6	94.6	94.6	94.6	94.5	94.5	94.4	94.4	94.3	94.3	94.2	94.1
90	94.2	94.2	94.2	94.2	94.2	94.2	94.2	94.2	94.2	94.2	94.2	94.2	94.2	94.2	94.2	94.1	94.1	94.1
95	94.1	94.1	94.1	94.1	94.1	94.1	94.1	94.1	94.1	94.1	94.1	94.1	94.1	94.1	94.1	94.1	94.1	94.1
98	94.1	94.1	94.1	94.1	94.1	94.1	94.1	94.1	94.1	94.1	94.1	94.1	94.1	94.1	94.1	94.1	94.1	94.1

**Mean Annual Mass Removal Efficiencies (%) for 4.00-inches of Retention for Zone 5**

NDCIA CN	Percent DCIA																	
	0-15	20	25	30	35	40	45	50	55	60	65	70	75	80	85	90	95	100
30	99.7	99.7	99.6	99.5	99.4	99.2	99.0	98.8	98.5	98.1	97.8	97.4	97.0	96.6	96.2	95.7	95.2	94.8
35	99.5	99.5	99.4	99.3	99.2	99.0	98.8	98.6	98.3	98.0	97.7	97.3	96.9	96.5	96.1	95.7	95.2	94.8
40	99.2	99.2	99.1	99.1	99.0	98.8	98.6	98.3	98.1	97.8	97.5	97.2	96.8	96.4	96.0	95.6	95.2	94.8
45	98.8	98.8	98.8	98.8	98.6	98.5	98.3	98.1	97.8	97.6	97.3	97.0	96.7	96.3	96.0	95.6	95.2	94.8
50	98.5	98.5	98.5	98.4	98.3	98.1	98.0	97.8	97.5	97.3	97.1	96.8	96.5	96.2	95.9	95.5	95.1	94.8
55	98.0	98.0	98.0	97.9	97.9	97.7	97.6	97.4	97.3	97.1	96.9	96.7	96.4	96.1	95.8	95.4	95.1	94.8
60	97.5	97.5	97.5	97.5	97.4	97.3	97.2	97.1	97.0	96.8	96.7	96.4	96.2	96.0	95.7	95.4	95.1	94.8
65	96.9	96.9	96.9	96.9	96.9	96.9	96.8	96.8	96.7	96.6	96.4	96.2	96.0	95.8	95.6	95.3	95.0	94.8
70	96.4	96.4	96.4	96.4	96.4	96.4	96.4	96.4	96.3	96.3	96.1	96.0	95.8	95.6	95.4	95.2	95.0	94.8
75	96.0	96.0	96.0	96.0	96.0	96.0	96.0	96.0	96.0	95.9	95.8	95.7	95.6	95.5	95.3	95.1	95.0	94.8
80	95.6	95.6	95.6	95.6	95.6	95.6	95.6	95.6	95.6	95.6	95.5	95.4	95.4	95.3	95.1	95.0	94.9	94.8
85	95.2	95.2	95.2	95.2	95.2	95.2	95.2	95.2	95.2	95.2	95.2	95.2	95.1	95.1	95.0	94.9	94.9	94.8
90	94.9	94.9	94.9	94.9	94.9	94.9	94.9	94.9	94.9	94.9	94.9	94.9	94.9	94.9	94.8	94.8	94.8	94.8
95	94.8	94.8	94.8	94.8	94.8	94.8	94.8	94.8	94.8	94.8	94.8	94.8	94.8	94.8	94.8	94.8	94.8	94.8
98	94.8	94.8	94.8	94.8	94.8	94.8	94.8	94.8	94.8	94.8	94.8	94.8	94.8	94.8	94.8	94.8	94.8	94.8

## APPENDIX G

### SENSITIVE KARST AREA MAPS AND LEGAL DESCRIPTIONS

This Appendix contains the maps and the legal descriptions for the Sensitive Karst Areas within the Northwest Florida Water Management District, the St. Johns River Water Management District and. Maps for the Suwannee River Water Management District and the Southwest Florida Water Management District still under development.

The DEP-WMD stormwater team seeks comment on the methodology to designate Sensitive Karst Areas. The NFWFMD identified SKAs as those areas with limerock within 100 feet of the land surface. The SJRWMD identified SKAs as those areas with limerock within 20 feet of the land surface. The third possible method is to use the Florida Aquifer Vulnerability Assessment method which is described at: <http://www.dep.state.fl.us/geology/programs/hydrogeology/fava.htm>. Remember that the purpose of identifying SKAs is to minimize the risk of sinkhole development within a stormwater retention or detention basin.



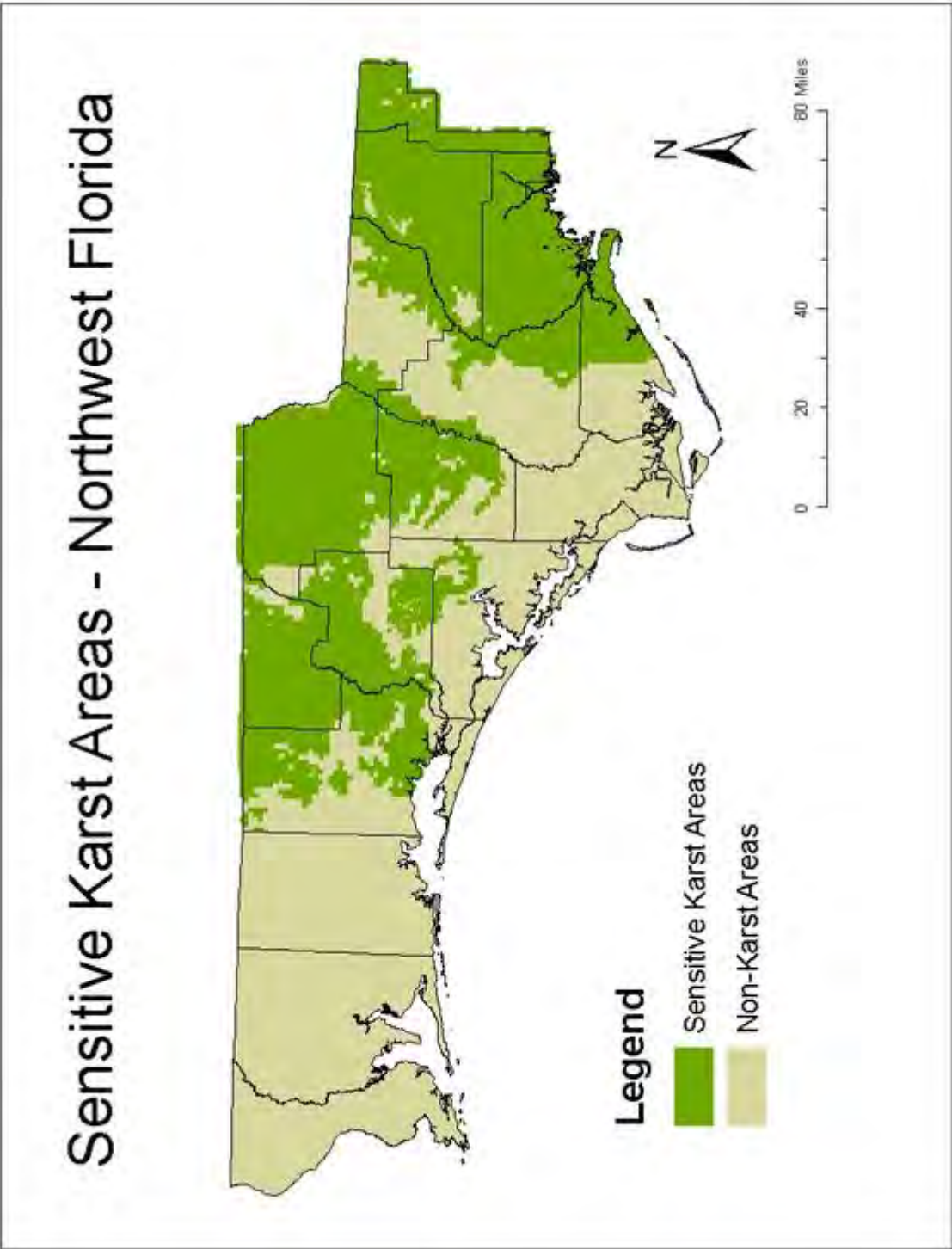

The following pages provide a location description of all lands included in the Sensitive Karst Areas, based on the Federal Section, Township, and Range system. Parcels are described to the “Section” level, with Section lines forming the boundary for Sensitive Karst Areas. All lands within the boundaries of a listed Section are included.

In some cases, all of the Sections within the boundary of a Township and Range are included. In those cases, only the Township and Range are specified; these listings appear at the end of the table for the county. The lack of a specified Section means that all Sections within such a Township and Range are included.

Additionally, if included parcels are located only within one county, they are listed under the title: “Part 1: Parcels Wholly Contained Within One County Boundary.” If included parcels cover areas located over two or more counties, they are listed under the title: “Part 2: Parcels Contained Within Multiple County Boundaries.” **Please be sure to check both Parts when searching for included parcels.**

**Part 1: Parcels Wholly Contained Within One County Boundary**

BAY COUNTY		
TOWNSHIP	RANGE	SECTION
1 N	12 W	6
1 S	12 W	5
1 S	12 W	6
1 S	12 W	8
1 S	12 W	9
1 S	12 W	16
1 S	12 W	17
1 S	12 W	21
1 S	12 W	25
1 S	12 W	25
1 S	12 W	27
1 S	12 W	28
1 S	12 W	32
1 S	12 W	33
1 S	12 W	35
1 S	12 W	36
1 S	13 W	3
1 S	13 W	4
1 S	13 W	5
1 S	13 W	6
1 S	13 W	7
1 S	13 W	8
1 S	13 W	9
1 S	13 W	10
1 S	13 W	11
1 S	13 W	14
1 S	13 W	15
1 S	13 W	16
1 S	13 W	17
1 S	13 W	18
1 S	13 W	20
1 S	13 W	21
1 S	13 W	22
1 S	13 W	23
1 S	13 W	28
1 S	13 W	29
1 S	13 W	32
1 S	13 W	33
1 S	13 W	36
1 S	14 W	1
1 S	14 W	1
1 S	14 W	2
1 S	14 W	3
1 S	14 W	4
1 S	14 W	5
1 S	14 W	5
1 S	14 W	9
1 S	14 W	10
1 S	14 W	10
1 S	14 W	11
1 S	14 W	12
1 S	14 W	36
1 S	16 W	4
1 S	16 W	4
2 N	12 W	31
2 S	12 W	2
2 S	12 W	3
2 S	12 W	4
2 S	12 W	5
2 S	12 W	7
2 S	12 W	8
2 S	12 W	9

BAY COUNTY		
TOWNSHIP	RANGE	SECTION
2 S	12 W	10
2 S	12 W	11
2 S	12 W	16
2 S	12 W	17
2 S	12 W	18
2 S	12 W	21
2 S	13 W	1
2 S	13 W	3
2 S	13 W	4
2 S	13 W	5
2 S	13 W	9
2 S	13 W	10
2 S	13 W	11
2 S	13 W	12
2 S	13 W	13
2 S	13 W	14
2 S	13 W	15
2 S	14 W	1

CALHOUN COUNTY		
TOWNSHIP	RANGE	SECTION
1 N	7 W	30
1 N	7 W	31
1 N	10 W	1
1 N	10 W	2
1 N	10 W	3
1 N	10 W	4
1 N	10 W	5
1 N	10 W	6
1 N	10 W	9
1 N	10 W	10
1 N	10 W	11
1 N	10 W	12
1 N	10 W	13
1 N	10 W	14
1 N	10 W	15
1 N	10 W	18
1 N	10 W	19
1 N	10 W	20
1 N	10 W	21
1 N	10 W	22
1 N	10 W	23
1 N	10 W	24
1 N	10 W	25
1 N	10 W	26
1 N	10 W	27
1 N	10 W	28
1 N	10 W	29
1 N	10 W	30
1 N	10 W	33
1 N	10 W	34
1 N	10 W	35
1 N	10 W	36
1 N	11 W	1
1 N	11 W	10
1 N	11 W	13
1 N	11 W	14
1 N	11 W	15
1 N	11 W	24
1 N	11 W	27
1 N	11 W	28
1 N	11 W	34

CALHOUN COUNTY		
TOWNSHIP	RANGE	SECTION
1 N	11 W	35
1 S	9 W	1
1 S	9 W	3
1 S	9 W	4
1 S	9 W	5
1 S	9 W	6
1 S	9 W	7
1 S	9 W	8
1 S	9 W	9
1 S	9 W	11
1 S	9 W	12
1 S	9 W	13
1 S	9 W	14
1 S	9 W	16
1 S	9 W	17
1 S	9 W	18
1 S	9 W	19
1 S	9 W	20
1 S	9 W	23
1 S	9 W	24
1 S	9 W	25
1 S	9 W	27
1 S	9 W	28
1 S	9 W	29
1 S	9 W	30
1 S	9 W	31
1 S	9 W	32
1 S	9 W	33
1 S	9 W	35
1 S	9 W	36
1 S	10 W	1
1 S	10 W	6
1 S	10 W	7
1 S	10 W	8
1 S	10 W	11
1 S	10 W	12
1 S	10 W	13
1 S	10 W	14
1 S	10 W	17
1 S	10 W	18
1 S	10 W	20
1 S	10 W	21
1 S	10 W	22
1 S	10 W	23
1 S	10 W	24
1 S	10 W	25
1 S	10 W	26
1 S	10 W	27
1 S	10 W	28
1 S	10 W	34
1 S	10 W	35
1 S	10 W	36
1 S	11 W	1
1 S	11 W	2
1 S	11 W	12
1 S	11 W	30
2 N	7 W	4
2 N	7 W	4
2 N	7 W	5
2 N	7 W	5
2 N	7 W	6
2 N	7 W	7

CALHOUN COUNTY		
TOWNSHIP	RANGE	SECTION
2 N	7 W	8
2 N	7 W	8
2 N	7 W	18
2 N	7 W	19
2 N	7 W	19
2 N	7 W	30
2 N	9 W	1
2 N	9 W	3
2 N	9 W	4
2 N	9 W	4
2 N	9 W	5
2 N	9 W	5
2 N	9 W	8
2 N	9 W	9
2 N	9 W	11
2 N	9 W	12
2 N	9 W	13
2 N	9 W	14
2 N	9 W	15
2 N	9 W	16
2 N	9 W	17
2 N	9 W	19
2 N	9 W	19
2 N	9 W	20
2 N	9 W	21
2 N	9 W	22
2 N	9 W	23
2 N	9 W	24
2 N	9 W	25
2 N	9 W	26
2 N	9 W	27
2 N	9 W	28
2 N	9 W	29
2 N	9 W	30
2 N	9 W	31
2 N	9 W	32
2 N	9 W	33
2 N	9 W	34
2 N	9 W	35
2 N	9 W	36
2 N	11 W	21
2 N	11 W	22
2 N	11 W	23
2 N	11 W	24
2 N	11 W	24
2 N	11 W	25
2 N	11 W	26
2 N	11 W	27
2 N	11 W	36
2 S	8 W	4
2 S	8 W	4
2 S	8 W	5
2 S	8 W	6
2 S	8 W	7
2 S	8 W	8
2 S	8 W	9
2 S	8 W	9
2 S	8 W	16
2 S	8 W	16
2 S	8 W	17
2 S	8 W	17
2 S	8 W	18
2 S	8 W	19
2 S	8 W	20
2 S	8 W	20
2 S	8 W	29

CALHOUN COUNTY		
TOWNSHIP	RANGE	SECTION
2 S	8 W	29
2 S	8 W	30
2 S	8 W	31
2 S	8 W	32
2 S	8 W	32
2 S	9 W	1
2 S	9 W	2
2 S	9 W	3
2 S	9 W	4
2 S	9 W	5
2 S	9 W	6
2 S	9 W	8
2 S	9 W	9
2 S	9 W	10
2 S	9 W	11
2 S	9 W	12
2 S	9 W	13
2 S	9 W	14
2 S	9 W	15
2 S	9 W	16
2 S	9 W	17
2 S	9 W	20
2 S	9 W	21
2 S	9 W	22
2 S	9 W	23
2 S	9 W	24
2 S	9 W	25
2 S	9 W	26
2 S	9 W	27
2 S	9 W	28
2 S	9 W	29
2 S	9 W	30
2 S	9 W	31
2 S	9 W	32
2 S	9 W	33
2 S	9 W	34
2 S	9 W	35
2 S	9 W	36
2 S	10 W	18
2 S	10 W	19
2 S	10 W	20
2 S	10 W	28
2 S	10 W	29
2 S	10 W	34
2 S	10 W	35
2 S	11 W	13
3 S	8 W	6
3 S	9 W	1
3 S	9 W	2
3 S	9 W	3
3 S	9 W	4
3 S	9 W	5
3 S	9 W	6
3 S	9 W	7
3 S	9 W	7
3 S	9 W	8
3 S	10 W	1
3 S	10 W	2
3 S	10 W	3
3 S	10 W	12
1 N	9 W	

FRANKLIN COUNTY		
TOWNSHIP	RANGE	SECTION
5 S	6 W	36
6 S	4 W	36

FRANKLIN COUNTY		
TOWNSHIP	RANGE	SECTION
8 S	3 W	72
8 S	4 W	73
8 S	5 W	3
8 S	5 W	4
8 S	5 W	5
8 S	5 W	8
8 S	5 W	9
8 S	5 W	24
8 S	5 W	25
8 S	5 W	26
8 S	5 W	34
8 S	5 W	35
9 S	5 W	3
4 S	5 W	
6 S	1 W	
6 S	1 W	
6 S	1 W	
6 S	2 W	
6 S	2 W	
6 S	3 W	
6 S	3 W	
6 S	3 W	
6 S	4 W	
6 S	5 W	
7 S	1 W	
7 S	3 W	
7 S	4 W	
7 S	4 W	
7 S	4 W	
7 S	5 W	

FRANKLIN COUNTY		
REMAINDER OF DOG ISLAND NOT ALREADY LISTED		

GADSDEN COUNTY		
TOWNSHIP	RANGE	SECTION
1 N	3 W	1
1 N	3 W	2
1 N	3 W	3
1 N	3 W	4
1 N	3 W	10
1 N	3 W	11
1 N	3 W	12
1 N	3 W	13
1 N	3 W	14
1 N	3 W	15
1 N	3 W	16
1 N	3 W	21
1 N	3 W	22
1 N	3 W	23
1 N	3 W	24
1 N	3 W	25
1 N	3 W	25
1 N	3 W	26
1 N	3 W	26
1 N	3 W	26
1 N	3 W	27
1 N	3 W	27
1 N	3 W	27
1 N	3 W	28
1 N	3 W	32
1 N	3 W	32
1 N	3 W	32
1 N	3 W	32

GADSDEN COUNTY		
TOWNSHIP	RANGE	SECTION
1 N	3 W	32
1 N	3 W	32
1 N	3 W	33
1 N	3 W	33
1 N	3 W	33
1 N	3 W	34
1 N	3 W	34
1 N	3 W	34
1 N	4 W	25
1 N	4 W	26
1 N	4 W	27
1 N	4 W	28
1 N	4 W	29
1 N	4 W	33
1 N	4 W	34
1 N	4 W	35
1 N	4 W	36
1 S	4 W	1
1 S	4 W	1
1 S	4 W	2
1 S	4 W	3
1 S	4 W	4
1 S	4 W	5
1 S	4 W	6
1 S	4 W	7
1 S	4 W	8
1 S	4 W	9
1 S	4 W	9
1 S	4 W	10
1 S	4 W	10
1 S	4 W	10
1 S	4 W	11
1 S	4 W	11
1 S	4 W	12
1 S	4 W	12
1 S	4 W	16
1 S	4 W	16
1 S	4 W	16
1 S	4 W	17
1 S	4 W	17
1 S	4 W	17
1 S	4 W	17
1 S	4 W	17
1 S	4 W	17
1 S	4 W	18
1 S	4 W	18
2 N	2 W	1
2 N	2 W	2
2 N	2 W	3
2 N	2 W	4
2 N	2 W	5
2 N	2 W	6
2 N	2 W	6
2 N	2 W	7
2 N	2 W	7
2 N	2 W	8
2 N	2 W	10
2 N	2 W	11
2 N	2 W	12
2 N	2 W	13
2 N	2 W	13
2 N	2 W	14
2 N	2 W	15
2 N	2 W	16
2 N	2 W	17
2 N	2 W	18

GADSDEN COUNTY		
TOWNSHIP	RANGE	SECTION
2 N	2 W	19
2 N	2 W	20
2 N	2 W	21
2 N	2 W	22
2 N	2 W	23
2 N	2 W	24
2 N	2 W	24
2 N	2 W	24
2 N	2 W	24
2 N	2 W	24
2 N	2 W	24
2 N	2 W	25
2 N	2 W	25
2 N	2 W	25
2 N	2 W	26
2 N	2 W	27
2 N	2 W	28
2 N	2 W	29
2 N	2 W	30
2 N	2 W	31
2 N	2 W	32
2 N	2 W	33
2 N	2 W	34
2 N	2 W	35
2 N	2 W	36
2 N	2 W	36
2 N	3 W	1
2 N	3 W	2
2 N	3 W	3
2 N	3 W	4
2 N	3 W	5
2 N	3 W	8
2 N	3 W	9
2 N	3 W	10
2 N	3 W	11
2 N	3 W	12
2 N	3 W	13
2 N	3 W	14
2 N	3 W	15
2 N	3 W	21
2 N	3 W	22
2 N	3 W	23
2 N	3 W	24
2 N	3 W	25
2 N	3 W	26
2 N	3 W	27
2 N	3 W	28
2 N	3 W	32
2 N	3 W	33
2 N	3 W	34
2 N	3 W	35
2 N	3 W	36
2 N	4 W	35
2 N	6 W	3
2 N	6 W	5
2 N	6 W	6
2 N	6 W	7
2 N	6 W	7
2 N	6 W	8
2 N	6 W	17
2 N	6 W	18
2 N	6 W	18
2 N	6 W	19
2 N	6 W	20
3 N	1 E	93
3 N	1 E	95
3 N	1 E	97
3 N	1 E	98
3 N	1 E	99

GADSDEN COUNTY		
TOWNSHIP	RANGE	SECTION
3 N	1 E	100
3 N	1 E	258
3 N	1 E	258
3 N	1 E	258
3 N	1 E	259
3 N	1 E	259
3 N	1 E	260
3 N	1 E	260
3 N	1 E	260
3 N	1 W	8
3 N	1 W	9
3 N	1 W	10
3 N	1 W	11
3 N	1 W	11
3 N	1 W	11
3 N	1 W	11
3 N	1 W	14
3 N	1 W	14
3 N	1 W	15
3 N	1 W	16
3 N	1 W	17
3 N	1 W	19
3 N	1 W	20
3 N	1 W	21
3 N	1 W	22
3 N	1 W	26
3 N	1 W	26
3 N	1 W	26
3 N	1 W	27
3 N	1 W	27
3 N	1 W	28
3 N	1 W	29
3 N	1 W	30
3 N	1 W	31
3 N	1 W	32
3 N	1 W	33
3 N	1 W	34
3 N	1 W	34
3 N	2 W	7
3 N	2 W	8
3 N	2 W	17
3 N	2 W	18
3 N	2 W	19
3 N	2 W	20
3 N	2 W	24
3 N	2 W	25
3 N	2 W	28
3 N	2 W	29
3 N	2 W	30
3 N	2 W	31
3 N	2 W	32
3 N	2 W	34
3 N	2 W	35
3 N	2 W	36
3 N	3 W	15
3 N	3 W	22
3 N	3 W	23
3 N	3 W	25
3 N	3 W	26
3 N	3 W	35
3 N	3 W	36
3 N	5 W	7
3 N	6 W	1
3 N	6 W	2
3 N	6 W	3
3 N	6 W	4



GADSDEN COUNTY		
TOWNSHIP	RANGE	SECTION
3 N	6 W	5
3 N	6 W	8
3 N	6 W	9
3 N	6 W	10
3 N	6 W	11
3 N	6 W	12
3 N	6 W	13
3 N	6 W	15
3 N	6 W	16
3 N	6 W	17
3 N	6 W	18
3 N	6 W	19
3 N	6 W	20
3 N	6 W	21
3 N	6 W	22
3 N	6 W	23
3 N	6 W	25
3 N	6 W	26
3 N	6 W	27
3 N	6 W	28
3 N	6 W	29
3 N	6 W	30
3 N	6 W	31
3 N	6 W	32
3 N	6 W	33
3 N	6 W	34
3 N	6 W	35
3 N	6 W	36
61 N	61 E	1
61 N	61 E	2
61 N	61 E	3
61 N	61 E	5
61 N	61 E	6
61 N	61 E	7
61 N	61 E	8
61 N	61 E	9
61 N	61 E	10
61 N	61 E	11
61 N	61 E	12
61 N	61 E	13
61 N	61 E	14
61 N	61 E	18
61 N	61 E	19
61 N	61 E	20
61 N	61 E	21
61 N	61 E	22
61 N	61 E	23
61 N	61 E	28
61 N	61 E	29
61 N	61 E	30
61 N	61 E	31
61 N	61 E	32
61 N	61 E	33
61 N	61 E	37
61 N	61 E	39
61 N	61 E	40
61 N	61 E	44
61 N	61 E	76
61 N	61 E	77
61 N	61 E	78
61 N	61 E	78
61 N	61 E	78
61 N	61 E	78
61 N	61 E	78
61 N	61 E	78
61 N	61 E	79

GADSDEN COUNTY		
TOWNSHIP	RANGE	SECTION
61 N	61 E	80
61 N	61 E	80
61 N	61 E	80
61 N	61 E	80
61 N	61 E	80
61 N	61 E	81
61 N	61 E	81
61 N	61 E	81
61 N	61 E	81
61 N	61 E	81

HOLMES COUNTY		
TOWNSHIP	RANGE	SECTION
3 N	17 W	33
3 N	18 W	1
3 N	18 W	2
3 N	18 W	3
3 N	18 W	10
3 N	18 W	11
3 N	18 W	12
3 N	18 W	13
3 N	18 W	14
3 N	18 W	15
3 N	18 W	15
3 N	18 W	15
3 N	18 W	22
3 N	18 W	22
3 N	18 W	23
3 N	18 W	24
3 N	18 W	25
3 N	18 W	26
3 N	18 W	27
3 N	18 W	36
5 N	14 W	5
5 N	14 W	6
5 N	14 W	7
5 N	14 W	8
5 N	14 W	11
5 N	14 W	12
5 N	14 W	12
5 N	14 W	14
5 N	14 W	14
5 N	14 W	14
5 N	14 W	14
5 N	14 W	18
5 N	14 W	19
5 N	14 W	23
5 N	14 W	23
5 N	14 W	23
5 N	14 W	23
5 N	14 W	26
5 N	14 W	26
5 N	14 W	26
5 N	14 W	27
5 N	14 W	28
5 N	14 W	29
5 N	14 W	30
5 N	14 W	31
5 N	14 W	32
5 N	14 W	33
5 N	14 W	34
5 N	14 W	35
5 N	14 W	35
5 N	14 W	35
5 N	14 W	35
6 N	13 W	4
6 N	13 W	4
6 N	13 W	4

HOLMES COUNTY		
TOWNSHIP	RANGE	SECTION
6 N	13 W	8
6 N	14 W	2
6 N	14 W	3
6 N	14 W	4
6 N	14 W	5
6 N	14 W	6
6 N	14 W	7
6 N	14 W	8
6 N	14 W	9
6 N	14 W	10
6 N	14 W	11
6 N	14 W	15
6 N	14 W	16
6 N	14 W	17
6 N	14 W	18
6 N	14 W	19
6 N	14 W	20
6 N	14 W	22
6 N	14 W	27
6 N	14 W	28
6 N	14 W	29
6 N	14 W	30
6 N	14 W	31
6 N	14 W	32
6 N	14 W	33
6 N	14 W	34
7 N	13 W	19
7 N	13 W	22
7 N	13 W	23
7 N	13 W	23
7 N	13 W	26
7 N	13 W	26
7 N	13 W	27
7 N	13 W	27
7 N	13 W	27
7 N	13 W	28
7 N	13 W	30
7 N	13 W	33
7 N	13 W	33
7 N	13 W	33
7 N	13 W	34
7 N	13 W	34
7 N	14 W	19
7 N	14 W	20
7 N	14 W	22
7 N	14 W	23
7 N	14 W	24
7 N	14 W	25
7 N	14 W	26
7 N	14 W	27
7 N	14 W	27
7 N	14 W	29
7 N	14 W	30
7 N	14 W	31
7 N	14 W	32
7 N	14 W	33
7 N	14 W	34
7 N	14 W	34
7 N	14 W	35
7 N	14 W	36
7 N	15 W	22
7 N	15 W	23
7 N	15 W	24
7 N	15 W	25
7 N	15 W	26
7 N	15 W	27
7 N	15 W	28
7 N	15 W	29

HOLMES COUNTY		
TOWNSHIP	RANGE	SECTION
7 N	15 W	31
7 N	15 W	32
7 N	15 W	33
7 N	15 W	34
7 N	15 W	35
7 N	15 W	36
4 N	17 W	
5 N	15 W	
5 N	16 W	
5 N	17 W	
6 N	15 W	
6 N	16 W	
6 N	17 W	
7 N	16 W	
7 N	17 W	

JACKSON COUNTY		
TOWNSHIP	RANGE	SECTION
2 N	9 W	6
2 N	9 W	6
2 N	9 W	6
2 N	9 W	7
2 N	9 W	7
2 N	9 W	18
2 N	9 W	18
2 N	11 W	1
2 N	11 W	11
2 N	11 W	12
2 N	11 W	13
2 N	11 W	14
2 N	11 W	14
2 N	11 W	14
3 N	6 W	6
3 N	6 W	6
3 N	6 W	7
3 N	6 W	7
3 N	9 W	1
3 N	9 W	2
3 N	9 W	3
3 N	9 W	4
3 N	9 W	5
3 N	9 W	6
3 N	9 W	7
3 N	9 W	8
3 N	9 W	9
3 N	9 W	10
3 N	9 W	11
3 N	9 W	12
3 N	9 W	13
3 N	9 W	14
3 N	9 W	15
3 N	9 W	16
3 N	9 W	17
3 N	9 W	18
3 N	9 W	19
3 N	9 W	20
3 N	9 W	21
3 N	9 W	22
3 N	9 W	23
3 N	9 W	24
3 N	9 W	25
3 N	9 W	26
3 N	9 W	27
3 N	9 W	28
3 N	9 W	29

JACKSON COUNTY		
TOWNSHIP	RANGE	SECTION
3 N	9 W	30
3 N	9 W	31
3 N	9 W	31
3 N	9 W	32
3 N	9 W	32
3 N	9 W	33
3 N	9 W	34
3 N	9 W	36
3 N	9 W	36
3 N	10 W	1
3 N	10 W	2
3 N	10 W	3
3 N	10 W	4
3 N	10 W	5
3 N	10 W	6
3 N	10 W	7
3 N	10 W	8
3 N	10 W	9
3 N	10 W	10
3 N	10 W	11
3 N	10 W	12
3 N	10 W	13
3 N	10 W	14
3 N	10 W	15
3 N	10 W	16
3 N	10 W	17
3 N	10 W	18
3 N	10 W	19
3 N	10 W	20
3 N	10 W	21
3 N	10 W	22
3 N	10 W	23
3 N	10 W	24
3 N	10 W	25
3 N	10 W	26
3 N	10 W	27
3 N	10 W	30
3 N	10 W	31
3 N	10 W	34
3 N	10 W	35
3 N	10 W	36
3 N	11 W	1
3 N	11 W	2
3 N	11 W	3
3 N	11 W	4
3 N	11 W	5
3 N	11 W	6
3 N	11 W	7
3 N	11 W	8
3 N	11 W	9
3 N	11 W	10
3 N	11 W	11
3 N	11 W	12
3 N	11 W	13
3 N	11 W	14
3 N	11 W	15
3 N	11 W	16
3 N	11 W	17
3 N	11 W	18
3 N	11 W	19
3 N	11 W	20
3 N	11 W	22
3 N	11 W	23
3 N	11 W	24
3 N	11 W	25
3 N	11 W	26

JACKSON COUNTY		
TOWNSHIP	RANGE	SECTION
3 N	11 W	27
3 N	11 W	28
3 N	11 W	29
3 N	11 W	30
3 N	11 W	34
3 N	11 W	35
3 N	11 W	36
3 N	12 W	1
3 N	12 W	2
3 N	12 W	3
3 N	12 W	10
3 N	12 W	10
3 N	12 W	11
3 N	12 W	12
3 N	12 W	13
3 N	12 W	14
3 N	12 W	15
3 N	12 W	15
3 N	12 W	15
3 N	12 W	22
4 N	7 W	4
4 N	7 W	4
4 N	7 W	5
4 N	7 W	6
4 N	7 W	7
4 N	7 W	8
4 N	7 W	8
4 N	7 W	8
4 N	7 W	9
4 N	7 W	15
4 N	7 W	16
4 N	7 W	17
4 N	7 W	17
4 N	7 W	18
4 N	7 W	19
4 N	7 W	20
4 N	7 W	21
4 N	7 W	22
4 N	7 W	23
4 N	7 W	25
4 N	7 W	26
4 N	7 W	27
4 N	7 W	28
4 N	7 W	29
4 N	7 W	30
4 N	7 W	31
4 N	7 W	32
4 N	7 W	33
4 N	7 W	34
4 N	7 W	35
4 N	7 W	36
4 N	12 W	1
4 N	12 W	2
4 N	12 W	3
4 N	12 W	10
4 N	12 W	10
4 N	12 W	11
4 N	12 W	12
4 N	12 W	13
4 N	12 W	14
4 N	12 W	15
4 N	12 W	15
4 N	12 W	15
4 N	12 W	22
4 N	12 W	22
4 N	12 W	23
4 N	12 W	24

JACKSON COUNTY		
TOWNSHIP	RANGE	SECTION
4 N	12 W	25
4 N	12 W	26
4 N	12 W	27
4 N	12 W	34
4 N	12 W	35
4 N	12 W	36
5 N	7 W	4
5 N	7 W	5
5 N	7 W	6
5 N	7 W	7
5 N	7 W	8
5 N	7 W	9
5 N	7 W	9
5 N	7 W	9
5 N	7 W	9
5 N	7 W	9
5 N	7 W	9
5 N	7 W	16
5 N	7 W	16
5 N	7 W	16
5 N	7 W	16
5 N	7 W	17
5 N	7 W	18
5 N	7 W	19
5 N	7 W	20
5 N	7 W	21
5 N	7 W	28
5 N	7 W	28
5 N	7 W	29
5 N	7 W	29
5 N	7 W	30
5 N	7 W	31
5 N	7 W	32
5 N	7 W	33
5 N	7 W	33
5 N	14 W	13
5 N	14 W	13
6 N	13 W	1
6 N	13 W	2
6 N	13 W	3
6 N	13 W	3
6 N	13 W	9
6 N	13 W	9
6 N	13 W	9
6 N	13 W	9
6 N	13 W	9
6 N	13 W	10
6 N	13 W	12
7 N	13 W	24
7 N	13 W	25
7 N	13 W	35
7 N	13 W	36
3 N	8 W	
4 N	10 W	
4 N	11 W	
4 N	8 W	
4 N	9 W	
5 N	10 W	
5 N	11 W	
5 N	8 W	
5 N	9 W	
6 N	10 W	
6 N	11 W	
6 N	12 W	
6 N	7 W	
6 N	8 W	

JACKSON COUNTY		
TOWNSHIP	RANGE	SECTION
6 N	9 W	
7 N	10 W	
7 N	11 W	
7 N	12 W	
7 N	8 W	
7 N	9 W	

JEFFERSON COUNTY		
TOWNSHIP	RANGE	SECTION
1 N	4 E	1
1 N	4 E	2
1 N	4 E	3
1 N	4 E	4
1 N	4 E	5
1 N	4 E	6
1 N	4 E	7
1 N	4 E	8
1 N	4 E	9
1 N	4 E	11
1 N	4 E	12
1 N	4 E	13
1 N	4 E	14
1 N	4 E	15
1 N	4 E	16
1 N	4 E	17
1 N	4 E	18
1 N	4 E	19
1 N	4 E	20
1 N	4 E	21
1 N	4 E	24
1 N	4 E	25
1 N	4 E	27
1 N	4 E	28
1 N	4 E	29
1 N	4 E	30
1 N	4 E	31
1 N	4 E	32
1 N	4 E	33
1 N	4 E	34
1 N	4 E	35
1 N	4 E	36
1 N	5 E	2
1 N	5 E	4
1 N	5 E	5
1 N	5 E	6
1 N	5 E	7
1 N	5 E	18
1 N	5 E	19
1 N	5 E	30
1 N	5 E	31
1 S	3 E	1
1 S	3 E	2
1 S	3 E	3
1 S	3 E	4
1 S	3 E	5
1 S	3 E	6
1 S	3 E	7
1 S	3 E	8
1 S	3 E	9
1 S	3 E	10
1 S	3 E	11
1 S	3 E	14
1 S	3 E	15
1 S	3 E	16
1 S	3 E	17
1 S	3 E	18

JEFFERSON COUNTY		
TOWNSHIP	RANGE	SECTION
1 S	3 E	19
1 S	3 E	20
1 S	3 E	21
1 S	3 E	22
1 S	3 E	23
1 S	3 E	26
1 S	3 E	27
1 S	3 E	28
1 S	3 E	29
1 S	3 E	30
1 S	3 E	31
1 S	3 E	32
1 S	3 E	33
1 S	3 E	34
1 S	3 E	35
1 S	4 E	1
1 S	4 E	2
1 S	4 E	3
1 S	4 E	4
1 S	4 E	5
1 S	4 E	6
2 N	5 E	1
2 N	5 E	2
2 N	5 E	3
2 N	5 E	4
2 N	5 E	5
2 N	5 E	6
2 N	5 E	7
2 N	5 E	8
2 N	5 E	9
2 N	5 E	10
2 N	5 E	11
2 N	5 E	12
2 N	5 E	13
2 N	5 E	14
2 N	5 E	15
2 N	5 E	16
2 N	5 E	17
2 N	5 E	18
2 N	5 E	19
2 N	5 E	20
2 N	5 E	21
2 N	5 E	22
2 N	5 E	23
2 N	5 E	24
2 N	5 E	25
2 N	5 E	26
2 N	5 E	27
2 N	5 E	28
2 N	5 E	29
2 N	5 E	31
2 N	5 E	32
2 N	5 E	33
2 N	5 E	34
2 N	5 E	35
2 N	6 E	6
2 N	6 E	18
2 N	6 E	19
2 S	3 E	2
2 S	3 E	3
2 S	3 E	4
2 S	3 E	5
2 S	3 E	6
2 S	3 E	7
2 S	3 E	8

JEFFERSON COUNTY		
TOWNSHIP	RANGE	SECTION
2 S	3 E	9
2 S	3 E	10
2 S	3 E	14
2 S	3 E	15
2 S	3 E	16
2 S	3 E	17
2 S	3 E	18
2 S	3 E	19
2 S	3 E	20
2 S	3 E	21
2 S	3 E	22
2 S	3 E	27
2 S	3 E	28
2 S	3 E	29
2 S	3 E	30
2 S	3 E	30
2 S	3 E	31
2 S	3 E	32
2 S	3 E	33
2 S	3 E	34
2 S	3 E	35
3 N	3 E	136
3 N	3 E	137
3 N	3 E	140
3 N	3 E	141
3 N	4 E	134
3 N	4 E	135
3 N	4 E	142
3 N	4 E	143
3 N	4 E	144
3 N	4 E	145
3 N	4 E	146
3 N	4 E	147
3 N	4 E	148
3 N	4 E	176
3 N	5 E	149
3 N	5 E	150
3 N	5 E	151
3 N	5 E	152
3 N	5 E	153
3 N	5 E	154
3 N	5 E	169
3 N	5 E	170
3 N	5 E	171
3 N	5 E	172
3 N	5 E	173
3 N	5 E	174
3 N	5 E	175
3 N	6 E	19
3 N	6 E	30
3 N	6 E	31
3 N	6 E	168
3 S	3 E	2
3 S	3 E	3
3 S	3 E	4
3 S	3 E	5
3 S	3 E	6
3 S	3 E	7
3 S	3 E	8
3 S	3 E	9
3 S	3 E	10
3 S	3 E	11
3 S	3 E	14
3 S	3 E	15
3 S	3 E	16
3 S	3 E	17

JEFFERSON COUNTY		
TOWNSHIP	RANGE	SECTION
3 S	3 E	18
3 S	3 E	19
3 S	3 E	20
3 S	3 E	21
3 S	3 E	22
3 S	3 E	23
3 S	3 E	26
3 S	3 E	27
3 S	3 E	28
3 S	3 E	29
3 S	3 E	30
3 S	3 E	30
3 S	3 E	31
3 S	3 E	32
3 S	3 E	33
3 S	3 E	34
4 S	3 E	2
4 S	3 E	3
4 S	3 E	4
4 S	3 E	5
4 S	3 E	6
4 S	3 E	6
4 S	3 E	7
4 S	3 E	7
4 S	3 E	8
4 S	3 E	9
4 S	3 E	10
4 S	3 E	11
4 S	3 E	14
4 S	3 E	15
4 S	3 E	16
4 S	3 E	17
4 S	3 E	18
4 S	3 E	18
4 S	3 E	19
4 S	3 E	20
4 S	3 E	21
4 S	3 E	22
4 S	3 E	23
4 S	3 E	26
4 S	3 E	26
4 S	3 E	27
4 S	3 E	27
4 S	3 E	28
4 S	3 E	29
4 S	3 E	30
2 N	4 E	
3 N	4 E	
3 N	5 E	

LEON COUNTY		
TOWNSHIP	RANGE	SECTION
1 N	3 W	31
1 N	3 W	31
1 N	3 W	31
1 N	3 W	31
1 N	3 W	31
1 N	3 W	35
1 N	3 W	36
1 S	3 W	1
1 S	3 W	2
1 S	3 W	3
1 S	3 W	4
1 S	3 W	4
1 S	3 W	5
1 S	3 W	6
1 S	3 W	6

LEON COUNTY		
TOWNSHIP	RANGE	SECTION
1 S	3 W	6
1 S	3 W	6
1 S	3 W	6
1 S	3 W	7
1 S	3 W	8
1 S	3 W	9
1 S	3 W	10
1 S	3 W	11
1 S	3 W	12
1 S	3 W	13
1 S	3 W	14
1 S	3 W	15
1 S	3 W	16
1 S	3 W	17
1 S	3 W	18
1 S	3 W	19
1 S	3 W	20
1 S	3 W	22
1 S	3 W	23
1 S	3 W	24
1 S	3 W	25
1 S	3 W	26
1 S	3 W	27
1 S	3 W	28
1 S	3 W	32
1 S	3 W	33
1 S	3 W	34
1 S	3 W	34
1 S	3 W	35
1 S	3 W	36
1 S	4 W	13
1 S	4 W	14
1 S	4 W	15
1 S	4 W	21
1 S	4 W	22
1 S	4 W	24
1 S	4 W	28
1 S	4 W	29
1 S	4 W	29
1 S	4 W	30
1 S	4 W	30
1 S	4 W	30
1 S	4 W	31
1 S	5 W	25
1 S	5 W	35
1 S	5 W	35
1 S	5 W	36
1 S	5 W	36
2 S	3 W	1
2 S	3 W	2
2 S	3 W	3
2 S	3 W	4
2 S	3 W	8
2 S	3 W	9
2 S	3 W	10
2 S	3 W	11
2 S	3 W	12
2 S	3 W	13
2 S	3 W	13
2 S	3 W	14
2 S	3 W	14
2 S	3 W	15
2 S	3 W	16
2 S	3 W	17

LEON COUNTY		
TOWNSHIP	RANGE	SECTION
2 S	3 W	18
2 S	3 W	18
2 S	4 W	6
2 S	4 W	7
2 S	4 W	8
2 S	4 W	13
2 S	4 W	14
2 S	4 W	17
2 S	4 W	17
2 S	4 W	18
2 S	4 W	18
2 S	5 W	2
2 S	5 W	2
3 N	1 E	261
3 N	1 W	12
3 N	1 W	13
3 N	1 W	23
3 N	1 W	23
3 N	1 W	24
3 N	1 W	25
3 N	1 W	35
3 N	1 W	36
3 N	1 W	36
3 N	3 E	138
3 N	3 E	138
1 N	1 E	
1 N	1 W	
1 N	2 E	
1 S	1 E	
1 S	1 W	
1 S	2 E	
1 S	2 W	
2 N	1 E	
2 N	2 E	
3 N	1 E	
3 N	2 E	

LIBERTY COUNTY		
TOWNSHIP	RANGE	SECTION
1 N	7 W	2
1 N	7 W	3
1 N	7 W	4
1 N	7 W	5
1 N	7 W	6
1 N	7 W	7
1 N	7 W	8
1 N	7 W	9
1 N	7 W	17
1 N	7 W	18
1 N	7 W	19
1 S	4 W	19
1 S	4 W	19
1 S	4 W	19
1 S	4 W	20
1 S	4 W	20
1 S	4 W	20
1 S	5 W	13
1 S	5 W	21
1 S	5 W	22
1 S	5 W	24
1 S	5 W	26
1 S	5 W	27
1 S	5 W	28
1 S	5 W	30
1 S	5 W	31
1 S	5 W	32

LIBERTY COUNTY		
TOWNSHIP	RANGE	SECTION
1 S	5 W	33
1 S	5 W	34
1 S	6 W	13
1 S	6 W	20
1 S	6 W	21
1 S	6 W	22
1 S	6 W	23
1 S	6 W	24
1 S	6 W	25
1 S	6 W	26
1 S	6 W	27
1 S	6 W	28
1 S	6 W	29
1 S	6 W	30
1 S	6 W	35
1 S	6 W	36
2 N	7 W	1
2 N	7 W	2
2 N	7 W	3
2 N	7 W	9
2 N	7 W	10
2 N	7 W	11
2 N	7 W	12
2 N	7 W	12
2 N	7 W	13
2 N	7 W	14
2 N	7 W	15
2 N	7 W	16
2 N	7 W	17
2 N	7 W	20
2 N	7 W	21
2 N	7 W	22
2 N	7 W	23
2 N	7 W	26
2 N	7 W	27
2 N	7 W	28
2 N	7 W	29
2 N	7 W	31
2 N	7 W	32
2 N	7 W	33
2 N	7 W	34
2 N	7 W	35
2 S	6 W	1
2 S	6 W	24
2 S	6 W	25
2 S	7 W	6
2 S	7 W	7
2 S	8 W	1
2 S	8 W	2
2 S	8 W	3
2 S	8 W	10
2 S	8 W	11
2 S	8 W	12
2 S	8 W	15
2 S	8 W	21
2 S	8 W	28
2 S	8 W	33
3 S	4 W	19
3 S	5 W	2
3 S	5 W	2
3 S	5 W	2
3 S	5 W	3
3 S	5 W	3
3 S	5 W	4
3 S	5 W	8

LIBERTY COUNTY		
TOWNSHIP	RANGE	SECTION
3 S	5 W	9
3 S	5 W	10
3 S	5 W	11
3 S	5 W	11
3 S	5 W	11
3 S	5 W	12
3 S	5 W	12
3 S	5 W	13
3 S	5 W	13
3 S	5 W	14
3 S	5 W	15
3 S	5 W	16
3 S	5 W	17
3 S	5 W	18
3 S	5 W	19
3 S	5 W	20
3 S	5 W	21
3 S	5 W	22
3 S	5 W	23
3 S	5 W	24
3 S	5 W	24
3 S	5 W	25
3 S	5 W	26
3 S	5 W	27
3 S	5 W	28
3 S	5 W	29
3 S	5 W	30
3 S	5 W	31
3 S	5 W	32
3 S	5 W	33
3 S	5 W	34
3 S	5 W	35
3 S	5 W	36
3 S	6 W	24
3 S	6 W	25
3 S	6 W	36
4 S	6 W	1
4 S	6 W	12
4 S	6 W	13
4 S	6 W	22
4 S	6 W	23
4 S	6 W	24
4 S	6 W	25
4 S	6 W	26
4 S	6 W	27
4 S	6 W	33
4 S	6 W	34
4 S	6 W	35
4 S	6 W	36
5 S	6 W	1
5 S	6 W	2
5 S	6 W	4
5 S	6 W	5
5 S	6 W	8
5 S	6 W	9
5 S	6 W	11
5 S	6 W	12
5 S	6 W	13
5 S	6 W	14
5 S	6 W	15
5 S	6 W	16
5 S	6 W	22
5 S	6 W	23
5 S	6 W	24
5 S	6 W	25
5 S	6 W	25



LIBERTY COUNTY		
TOWNSHIP	RANGE	SECTION
5 S	6 W	26

WAKULLA COUNTY		
TOWNSHIP	RANGE	SECTION
2 S	3 W	19
2 S	3 W	20
2 S	3 W	20
2 S	3 W	21
2 S	3 W	21
2 S	3 W	22
2 S	3 W	22
2 S	3 W	23
2 S	3 W	23
2 S	3 W	24
2 S	3 W	24
2 S	3 W	24
2 S	3 W	25
2 S	3 W	26
2 S	3 W	27
2 S	3 W	28
2 S	3 W	29
2 S	3 W	30
2 S	3 W	31
2 S	3 W	32
2 S	3 W	33
2 S	3 W	34
2 S	3 W	35
2 S	3 W	36
2 S	4 W	19
2 S	4 W	20
2 S	4 W	20
2 S	4 W	21
2 S	4 W	22
2 S	4 W	23
2 S	4 W	24
2 S	4 W	24
2 S	4 W	25
2 S	4 W	26
2 S	4 W	27
2 S	4 W	28
2 S	4 W	29
2 S	4 W	31
2 S	4 W	32
2 S	4 W	33
2 S	4 W	34
2 S	4 W	35
2 S	4 W	36
3 S	2 E	25
3 S	2 E	36
3 S	5 W	1
4 S	1 E	10
4 S	2 E	12
4 S	2 E	34
4 S	2 E	35
4 S	2 E	36
5 S	1 W	31
5 S	1 W	32
5 S	2 W	31
5 S	2 W	32
5 S	3 W	33
5 S	3 W	34
6 S	2 W	5
3 S	1 W	
3 S	2 E	
3 S	2 W	
3 S	3 W	
4 S	1 E	

WAKULLA COUNTY		
TOWNSHIP	RANGE	SECTION
4 S	2 E	
4 S	2 W	
4 S	3 W	
5 S	1 E	
5 S	1 W	
5 S	2 E	
5 S	2 W	
6 S	2 W	
6 S	2 W	
6 S	3 W	

WAKULLA COUNTY – SPANISH LAND GRANT		
TOWNSHIP	RANGE	SECTION
60 N	60 E	1
60 N	60 E	2
60 N	60 E	3
60 N	60 E	4
60 N	60 E	5
60 N	60 E	5
60 N	60 E	6
60 N	60 E	7
60 N	60 E	8
60 N	60 E	9
60 N	60 E	10
60 N	60 E	11
60 N	60 E	11
60 N	60 E	12
60 N	60 E	13
60 N	60 E	14
60 N	60 E	15
60 N	60 E	16
60 N	60 E	17
60 N	60 E	18
60 N	60 E	19
60 N	60 E	20
60 N	60 E	21
60 N	60 E	22
60 N	60 E	23
60 N	60 E	24
60 N	60 E	25
60 N	60 E	26
60 N	60 E	27
60 N	60 E	28
60 N	60 E	29
60 N	60 E	30
60 N	60 E	31
60 N	60 E	32
60 N	60 E	33
60 N	60 E	34
60 N	60 E	35
60 N	60 E	36
60 N	60 E	37
60 N	60 E	38
60 N	60 E	39
60 N	60 E	40
60 N	60 E	41
60 N	60 E	42
60 N	60 E	43
60 N	60 E	44
60 N	60 E	45
60 N	60 E	46
60 N	60 E	47
60 N	60 E	48
60 N	60 E	49
60 N	60 E	50

WAKULLA COUNTY – SPANISH LAND GRANT		
TOWNSHIP	RANGE	SECTION
60 N	60 E	51
60 N	60 E	52
60 N	60 E	53
60 N	60 E	54
60 N	60 E	55
60 N	60 E	56
60 N	60 E	57
60 N	60 E	58
60 N	60 E	59
60 N	60 E	60
60 N	60 E	61
60 N	60 E	62
60 N	60 E	63
60 N	60 E	64
60 N	60 E	65
60 N	60 E	66
60 N	60 E	67
60 N	60 E	68
60 N	60 E	69
60 N	60 E	70
60 N	60 E	71
60 N	60 E	72
60 N	60 E	73
60 N	60 E	74
60 N	60 E	75
60 N	60 E	76
60 N	60 E	77
60 N	60 E	78
60 N	60 E	79
60 N	60 E	80
60 N	60 E	81
60 N	60 E	82
60 N	60 E	83
60 N	60 E	84
60 N	60 E	85
60 N	60 E	86
60 N	60 E	87
60 N	60 E	88
60 N	60 E	89
60 N	60 E	90
60 N	60 E	91
60 N	60 E	92
60 N	60 E	93
60 N	60 E	94
60 N	60 E	95
60 N	60 E	96
60 N	60 E	97
60 N	60 E	98
60 N	60 E	99
60 N	60 E	100
60 N	60 E	101
60 N	60 E	102
60 N	60 E	103
60 N	60 E	104
60 N	60 E	105
60 N	60 E	106
60 N	60 E	107
60 N	60 E	108
60 N	60 E	109
60 N	60 E	110
60 N	60 E	111
60 N	60 E	112
60 N	60 E	113
60 N	60 E	114
60 N	60 E	115

WAKULLA COUNTY – SPANISH LAND GRANT		
TOWNSHIP	RANGE	SECTION
60 N	60 E	116
60 N	60 E	117
60 N	60 E	118
60 N	60 E	119
60 N	60 E	120
60 N	60 E	121
60 N	60 E	121
60 N	60 E	121
60 N	60 E	125
60 N	60 E	126
60 N	60 E	127
60 N	60 E	128
60 N	60 E	501
60 N	60 E	502
60 N	60 E	503
60 N	60 E	504
60 N	60 E	505
60 N	60 E	700
60 N	60 E	701
60 N	60 E	701
60 N	60 E	801
60 N	60 E	802
60 N	60 E	803
60 N	60 E	901
60 N	60 E	902
60 N	60 E	903
60 N	60 E	904
60 N	60 E	906
60 N	60 E	907
60 N	60 E	908
60 N	60 E	909
60 N	60 E	910
60 N	60 E	911

<b>WAKULLA COUNTY</b>
ALL OF PINEY ISLAND

WALTON COUNTY		
TOWNSHIP	RANGE	SECTION
1 N	16 W	6
1 N	16 W	6
1 N	16 W	7
1 N	16 W	7
1 N	16 W	8
1 N	16 W	8
1 N	16 W	8
1 N	16 W	17
1 N	16 W	17
1 N	16 W	17
1 N	16 W	17
1 N	16 W	17
1 N	16 W	18
1 N	16 W	19
1 N	16 W	19
1 N	16 W	19
1 N	16 W	19
1 N	16 W	20
1 N	16 W	20
1 N	16 W	30
1 N	16 W	30
1 N	16 W	30
1 N	16 W	30
1 N	17 W	1
1 N	17 W	2
1 N	17 W	3
1 N	17 W	7

WALTON COUNTY		
TOWNSHIP	RANGE	SECTION
1 N	17 W	8
1 N	17 W	9
1 N	17 W	10
1 N	17 W	11
1 N	17 W	12
1 N	17 W	13
1 N	17 W	14
1 N	17 W	15
1 N	17 W	16
1 N	17 W	17
1 N	17 W	18
1 N	17 W	19
1 N	17 W	20
1 N	17 W	21
1 N	17 W	22
1 N	17 W	23
1 N	17 W	24
1 N	17 W	25
1 N	17 W	25
1 N	17 W	25
1 N	17 W	26
1 N	17 W	27
1 N	17 W	28
1 N	17 W	35
1 N	17 W	36
1 N	17 W	36
1 N	17 W	36
1 N	18 W	1
1 N	18 W	2
1 N	18 W	3
1 N	18 W	4
1 N	18 W	5
1 N	18 W	6
1 N	18 W	9
1 N	18 W	10
1 N	18 W	11
1 N	18 W	12
1 N	18 W	13
1 N	18 W	14
1 N	18 W	15
1 N	18 W	17
1 N	18 W	18
1 N	18 W	19
1 N	18 W	22
1 N	18 W	23
1 N	18 W	24
1 N	18 W	25
1 N	18 W	28
1 N	18 W	29
1 N	18 W	30
1 N	18 W	31
1 N	18 W	32
1 N	18 W	33
1 N	18 W	34
1 N	19 W	5
1 N	19 W	6
1 N	19 W	8
1 N	19 W	9
1 N	19 W	10
1 N	19 W	16
1 N	19 W	17
1 N	19 W	18
1 N	19 W	19
1 N	19 W	20
1 N	19 W	24
1 N	19 W	25

WALTON COUNTY		
TOWNSHIP	RANGE	SECTION
1 N	19 W	26
1 N	19 W	27
1 N	19 W	28
1 N	19 W	29
1 N	19 W	30
1 N	19 W	31
1 N	19 W	32
1 N	19 W	33
1 N	19 W	34
1 N	19 W	35
1 N	19 W	36
1 N	20 W	11
1 N	20 W	12
1 N	20 W	13
1 N	20 W	14
1 N	20 W	24
1 N	20 W	27
1 N	20 W	33
1 N	20 W	34
1 N	20 W	35
1 N	20 W	36
1 S	18 W	3
1 S	18 W	4
1 S	18 W	5
1 S	18 W	6
1 S	18 W	7
1 S	18 W	8
1 S	18 W	9
1 S	18 W	10
1 S	18 W	11
1 S	18 W	12
1 S	18 W	13
1 S	18 W	14
1 S	18 W	15
1 S	18 W	16
1 S	18 W	17
1 S	18 W	18
1 S	18 W	19
1 S	18 W	20
1 S	18 W	21
1 S	18 W	22
1 S	18 W	23
1 S	18 W	24
1 S	18 W	25
1 S	18 W	26
1 S	18 W	27
1 S	18 W	28
1 S	18 W	29
1 S	18 W	30
1 S	18 W	31
1 S	18 W	32
1 S	18 W	33
1 S	18 W	34
1 S	18 W	35
1 S	20 W	1
1 S	20 W	3
1 S	20 W	4
1 S	20 W	9
1 S	20 W	10
1 S	20 W	11
1 S	20 W	12
1 S	20 W	13
1 S	20 W	14
1 S	20 W	15
1 S	20 W	16
1 S	20 W	23

WALTON COUNTY		
TOWNSHIP	RANGE	SECTION
1 S	20 W	24
1 S	20 W	25
2 N	16 W	19
2 N	16 W	19
2 N	16 W	19
2 N	16 W	30
2 N	16 W	30
2 N	16 W	31
2 N	16 W	31
2 N	17 W	2
2 N	17 W	2
2 N	17 W	3
2 N	17 W	4
2 N	17 W	5
2 N	17 W	6
2 N	17 W	7
2 N	17 W	8
2 N	17 W	9
2 N	17 W	10
2 N	17 W	11
2 N	17 W	11
2 N	17 W	13
2 N	17 W	13
2 N	17 W	14
2 N	17 W	14
2 N	17 W	15
2 N	17 W	16
2 N	17 W	17
2 N	17 W	18
2 N	17 W	19
2 N	17 W	20
2 N	17 W	21
2 N	17 W	22
2 N	17 W	23
2 N	17 W	24
2 N	17 W	24
2 N	17 W	25
2 N	17 W	26
2 N	17 W	27
2 N	17 W	28
2 N	17 W	29
2 N	17 W	30
2 N	17 W	32
2 N	17 W	34
2 N	17 W	35
2 N	17 W	36
2 N	18 W	13
2 N	18 W	14
2 N	18 W	15
2 N	18 W	22
2 N	18 W	23
2 N	18 W	24
2 N	18 W	25
2 N	18 W	26
2 N	18 W	27
2 N	18 W	29
2 N	18 W	30
2 N	18 W	31
2 N	18 W	32
2 N	18 W	33
2 N	18 W	34
2 N	18 W	35
2 N	18 W	36
2 N	19 W	4
2 N	19 W	5
2 N	19 W	6

WALTON COUNTY		
TOWNSHIP	RANGE	SECTION
2 N	19 W	7
2 N	19 W	27
2 N	19 W	28
2 N	19 W	29
2 N	19 W	32
2 N	19 W	33
2 N	20 W	1
2 N	20 W	2
2 N	20 W	3
2 N	20 W	4
2 N	20 W	9
2 N	20 W	10
2 N	20 W	11
2 N	20 W	12
2 N	20 W	13
2 S	19 W	1
2 S	19 W	2
3 N	17 W	1
3 N	17 W	2
3 N	17 W	3
3 N	17 W	4
3 N	17 W	5
3 N	17 W	6
3 N	17 W	8
3 N	17 W	9
3 N	17 W	10
3 N	17 W	11
3 N	17 W	12
3 N	17 W	13
3 N	17 W	14
3 N	17 W	15
3 N	17 W	16
3 N	17 W	17
3 N	17 W	18
3 N	17 W	19
3 N	17 W	20
3 N	17 W	21
3 N	17 W	22
3 N	17 W	23
3 N	17 W	23
3 N	17 W	24
3 N	17 W	24
3 N	17 W	24
3 N	17 W	25
3 N	17 W	25
3 N	17 W	25
3 N	17 W	26
3 N	17 W	26
3 N	17 W	26
3 N	17 W	26
3 N	17 W	27
3 N	17 W	28
3 N	17 W	29
3 N	17 W	30
3 N	17 W	31
3 N	17 W	32
3 N	17 W	34
3 N	17 W	35
3 N	17 W	35
3 N	18 W	4
3 N	18 W	5
3 N	18 W	6
3 N	18 W	7
3 N	18 W	8
3 N	18 W	9
3 N	18 W	16

WALTON COUNTY		
TOWNSHIP	RANGE	SECTION
3 N	18 W	17
3 N	18 W	18
3 N	18 W	19
3 N	18 W	20
3 N	18 W	21
3 N	19 W	1
3 N	19 W	5
3 N	19 W	6
3 N	19 W	6
3 N	19 W	7
3 N	19 W	7
3 N	19 W	8
3 N	19 W	8
3 N	19 W	11
3 N	19 W	12
3 N	19 W	13
3 N	19 W	14
3 N	19 W	15
3 N	19 W	18
3 N	19 W	23
3 N	19 W	24
3 N	19 W	31
3 N	20 W	1
3 N	20 W	1
3 N	20 W	2
3 N	20 W	3
3 N	20 W	4
3 N	20 W	5
3 N	20 W	6
3 N	20 W	9
3 N	20 W	10
3 N	20 W	11
3 N	20 W	12
3 N	20 W	14
3 N	20 W	25
3 N	20 W	26
3 N	20 W	34
3 N	20 W	35
3 N	20 W	36
4 N	19 W	2
4 N	19 W	4
4 N	19 W	5
4 N	19 W	6
4 N	19 W	7
4 N	19 W	8
4 N	19 W	9
4 N	19 W	10
4 N	19 W	11
4 N	19 W	13
4 N	19 W	15
4 N	19 W	16
4 N	19 W	18
4 N	19 W	19
4 N	19 W	20
4 N	19 W	21
4 N	19 W	22
4 N	19 W	23
4 N	19 W	24
4 N	19 W	25
4 N	19 W	26
4 N	19 W	28
4 N	19 W	31
4 N	19 W	32
4 N	19 W	33

WALTON COUNTY		
TOWNSHIP	RANGE	SECTION
4 N	19 W	35
4 N	19 W	36
4 N	20 W	1
4 N	20 W	4
4 N	20 W	8
4 N	20 W	9
4 N	20 W	11
4 N	20 W	12
4 N	20 W	13
4 N	20 W	14
4 N	20 W	16
4 N	20 W	17
4 N	20 W	20
4 N	20 W	21
4 N	20 W	22
4 N	20 W	23
4 N	20 W	24
4 N	20 W	25
4 N	20 W	26
4 N	20 W	27
4 N	20 W	28
4 N	20 W	29
4 N	20 W	31
4 N	20 W	32
4 N	20 W	33
4 N	20 W	34
4 N	20 W	35
4 N	20 W	36
4 N	21 W	36
5 N	19 W	1
5 N	19 W	2
5 N	19 W	3
5 N	19 W	4
5 N	19 W	5
5 N	19 W	6
5 N	19 W	7
5 N	19 W	8
5 N	19 W	9
5 N	19 W	10
5 N	19 W	11
5 N	19 W	12
5 N	19 W	13
5 N	19 W	14
5 N	19 W	15
5 N	19 W	16
5 N	19 W	17
5 N	19 W	18
5 N	19 W	19
5 N	19 W	20
5 N	19 W	21
5 N	19 W	22
5 N	19 W	23
5 N	19 W	24
5 N	19 W	25
5 N	19 W	26
5 N	19 W	27
5 N	19 W	28
5 N	19 W	29
5 N	19 W	30
5 N	19 W	31
5 N	19 W	32
5 N	19 W	33
5 N	19 W	34
5 N	19 W	35
5 N	20 W	1
5 N	20 W	2

WALTON COUNTY		
TOWNSHIP	RANGE	SECTION
5 N	20 W	3
5 N	20 W	4
5 N	20 W	5
5 N	20 W	8
5 N	20 W	10
5 N	20 W	11
5 N	20 W	12
5 N	20 W	13
5 N	20 W	14
5 N	20 W	15
5 N	20 W	22
5 N	20 W	23
5 N	20 W	24
5 N	20 W	25
5 N	20 W	26
5 N	20 W	27
5 N	20 W	35
5 N	20 W	36
5 N	21 W	2
5 N	21 W	7
5 N	21 W	10
5 N	21 W	11
5 N	21 W	14
5 N	21 W	15
5 N	21 W	16
5 N	21 W	18
5 N	21 W	23
6 N	20 W	25
6 N	20 W	26
6 N	20 W	27
6 N	20 W	28
6 N	20 W	31
6 N	20 W	32
6 N	20 W	33
6 N	20 W	34
6 N	20 W	35
6 N	20 W	36
6 N	21 W	28
6 N	21 W	32
6 N	21 W	33
6 N	21 W	34
6 N	30 W	29
1 S	19 W	
6 N	19 W	

WASHINGTON COUNTY		
TOWNSHIP	RANGE	SECTION
1 N	14 W	1
1 N	14 W	2
1 N	14 W	3
1 N	14 W	4
1 N	14 W	5
1 N	14 W	6
1 N	14 W	7
1 N	14 W	8
1 N	14 W	9
1 N	14 W	10
1 N	14 W	10
1 N	14 W	10
1 N	14 W	11
1 N	14 W	12
1 N	14 W	13
1 N	14 W	13
1 N	14 W	13
1 N	14 W	13
1 N	14 W	14

WASHINGTON COUNTY		
TOWNSHIP	RANGE	SECTION
1 N	14 W	15
1 N	14 W	16
1 N	14 W	17
1 N	14 W	19
1 N	14 W	20
1 N	14 W	21
1 N	14 W	22
1 N	14 W	23
1 N	14 W	24
1 N	14 W	24
1 N	14 W	25
1 N	14 W	26
1 N	14 W	27
1 N	14 W	28
1 N	14 W	29
1 N	14 W	30
1 N	14 W	32
1 N	14 W	33
1 N	14 W	33
1 N	14 W	34
1 N	14 W	34
1 N	14 W	35
1 N	14 W	36
1 N	14 W	36
1 N	15 W	1
1 N	15 W	2
1 N	15 W	5
1 N	15 W	6
1 N	15 W	7
1 N	15 W	8
1 N	15 W	9
1 N	15 W	11
1 N	15 W	12
1 N	15 W	17
1 N	15 W	18
1 N	15 W	24
1 N	16 W	1
1 N	16 W	2
1 N	16 W	3
1 N	16 W	3
1 N	16 W	4
1 N	16 W	5
1 N	16 W	9
1 N	16 W	10
1 N	16 W	10
1 N	16 W	11
1 N	16 W	12
1 N	16 W	13
1 N	16 W	14
1 N	16 W	15
1 N	16 W	16
1 N	16 W	16
1 N	16 W	22
1 N	16 W	23
1 N	16 W	26
1 N	16 W	27
1 N	16 W	29
1 N	16 W	31
1 N	16 W	32
1 N	16 W	33
1 N	16 W	34
1 N	16 W	35
1 S	16 W	5
1 S	16 W	5
1 S	17 W	1
2 N	13 W	19

WASHINGTON COUNTY		
TOWNSHIP	RANGE	SECTION
2 N	13 W	20
2 N	13 W	21
2 N	13 W	27
2 N	13 W	28
2 N	13 W	29
2 N	13 W	30
2 N	13 W	30
2 N	13 W	31
2 N	13 W	32
2 N	13 W	33
2 N	13 W	34
2 N	14 W	20
2 N	14 W	21
2 N	14 W	23
2 N	14 W	24
2 N	14 W	25
2 N	14 W	26
2 N	14 W	27
2 N	14 W	28
2 N	14 W	29
2 N	14 W	30
2 N	14 W	31
2 N	14 W	32
2 N	14 W	33
2 N	14 W	34
2 N	14 W	35
2 N	14 W	36
2 N	15 W	1
2 N	15 W	2
2 N	15 W	3
2 N	15 W	4
2 N	15 W	5
2 N	15 W	6
2 N	15 W	7
2 N	15 W	8
2 N	15 W	9
2 N	15 W	10
2 N	15 W	11
2 N	15 W	16
2 N	15 W	17
2 N	15 W	18
2 N	15 W	19
2 N	15 W	24
2 N	15 W	36
2 N	16 W	1
2 N	16 W	2
2 N	16 W	3
2 N	16 W	4
2 N	16 W	5
2 N	16 W	6
2 N	16 W	6
2 N	16 W	7
2 N	16 W	8
2 N	16 W	9
2 N	16 W	10
2 N	16 W	11
2 N	16 W	12
2 N	16 W	13
2 N	16 W	14
2 N	16 W	15
2 N	16 W	16
2 N	16 W	17
2 N	16 W	18
2 N	16 W	18
2 N	16 W	18
2 N	16 W	20

WASHINGTON COUNTY		
TOWNSHIP	RANGE	SECTION
2 N	16 W	21
2 N	16 W	22
2 N	16 W	23
2 N	16 W	24
2 N	16 W	24
2 N	16 W	25
2 N	16 W	27
2 N	16 W	28
2 N	16 W	29
2 N	16 W	32
2 N	16 W	33
2 N	16 W	34
2 N	16 W	37
2 N	17 W	1
2 N	17 W	12
3 N	12 W	4
3 N	12 W	4
3 N	12 W	6
3 N	12 W	7
3 N	12 W	8
3 N	12 W	9
3 N	12 W	9
3 N	12 W	16
3 N	12 W	17
3 N	12 W	18
3 N	12 W	19
3 N	12 W	20
3 N	12 W	21
3 N	12 W	29
3 N	12 W	30
3 N	13 W	1
3 N	13 W	2
3 N	13 W	3
3 N	13 W	4
3 N	13 W	5
3 N	13 W	6
3 N	13 W	7
3 N	13 W	8
3 N	13 W	9
3 N	13 W	12
3 N	13 W	13
3 N	13 W	14
3 N	13 W	17
3 N	13 W	18
3 N	13 W	19
3 N	13 W	19
3 N	13 W	20
3 N	13 W	21
3 N	13 W	23
3 N	13 W	24
3 N	13 W	25
3 N	13 W	26
3 N	13 W	27
3 N	13 W	28
3 N	13 W	29
3 N	13 W	30
3 N	13 W	33
3 N	13 W	34
3 N	13 W	35
3 N	14 W	1
3 N	14 W	2
3 N	14 W	3
3 N	14 W	4
3 N	14 W	5
3 N	14 W	6
3 N	14 W	7

WASHINGTON COUNTY		
TOWNSHIP	RANGE	SECTION
3 N	14 W	8
3 N	14 W	9
3 N	14 W	10
3 N	14 W	11
3 N	14 W	12
3 N	14 W	13
3 N	14 W	14
3 N	14 W	15
3 N	14 W	16
3 N	14 W	17
3 N	14 W	18
3 N	14 W	19
3 N	14 W	20
3 N	14 W	21
3 N	14 W	22
3 N	14 W	23
3 N	14 W	24
3 N	14 W	30
3 N	14 W	31
3 N	17 W	36
4 N	12 W	4
4 N	12 W	4
4 N	12 W	4
4 N	12 W	4
4 N	12 W	5
4 N	12 W	5
4 N	12 W	6
4 N	12 W	6
4 N	12 W	7
4 N	12 W	8
4 N	12 W	9
4 N	12 W	9
4 N	12 W	9
4 N	12 W	9
4 N	12 W	16
4 N	12 W	16
4 N	12 W	17
4 N	12 W	19
4 N	12 W	20
4 N	12 W	21
4 N	12 W	21
4 N	12 W	28
4 N	12 W	28
4 N	12 W	29
4 N	12 W	30
4 N	12 W	31
4 N	12 W	32
4 N	12 W	33
4 N	12 W	33
4 N	13 W	1
4 N	13 W	2
4 N	13 W	3



WASHINGTON COUNTY		
TOWNSHIP	RANGE	SECTION
4 N	13 W	4
4 N	13 W	5
4 N	13 W	6
4 N	13 W	7
4 N	13 W	8
4 N	13 W	9
4 N	13 W	10
4 N	13 W	14
4 N	13 W	16
4 N	13 W	17
4 N	13 W	18
4 N	13 W	19
4 N	13 W	20
4 N	13 W	21
4 N	13 W	22
4 N	13 W	23

WASHINGTON COUNTY		
TOWNSHIP	RANGE	SECTION
4 N	13 W	25
4 N	13 W	26
4 N	13 W	27
4 N	13 W	28
4 N	13 W	29
4 N	13 W	30
4 N	13 W	31
4 N	13 W	32
4 N	13 W	33
4 N	13 W	34
4 N	13 W	35
4 N	13 W	36
5 N	13 W	19
5 N	13 W	29
5 N	13 W	30
5 N	13 W	31

WASHINGTON COUNTY		
TOWNSHIP	RANGE	SECTION
5 N	13 W	32
5 N	13 W	33
5 N	13 W	34
5 N	14 W	24
5 N	14 W	24
5 N	14 W	24
5 N	14 W	24
5 N	14 W	24
5 N	14 W	24
5 N	14 W	24
5 N	14 W	24
5 N	14 W	24
5 N	14 W	25
5 N	14 W	36
1 N	13 W	
3 N	15 W	

**Part 2: Parcels Contained Within Multiple County Boundaries**

CALHOUN/LIBERTY COUNTIES		
TOWNSHIP	RANGE	SECTION
1 N	8 W	
1 S	8 W	
2 N	8 W	

HOLMES/WASHINGTON COUNTIES		
TOWNSHIP	RANGE	SECTION
4 N	14 W	
4 N	15 W	
4 N	16 W	

JACKSON/CALHOUN COUNTIES		
TOWNSHIP	RANGE	SECTION
2 N	10 W	

JACKSON/GADSDEN COUNTIES		
TOWNSHIP	RANGE	SECTION
3 N	7 W	
4 N	6 W	

JACKSON/WASHINGTON COUNTIES		
TOWNSHIP	RANGE	SECTION
5 N	12 W	

LEON/GADSDEN COUNTIES		
TOWNSHIP	RANGE	SECTION
1 N	2 W	
2 N	1 W	

LEON/JEFFERSON COUNTIES		
TOWNSHIP	RANGE	SECTION
1 N	3 E	
2 N	3 E	
3 N	3 E	

LEON/WAKULLA COUNTIES		
TOWNSHIP	RANGE	SECTION
2 S	1 E	
2 S	1 W	
2 S	2 E	
2 S	2 W	

LEON/WAKULLA/LIBERTY COUNTIES		
TOWNSHIP	RANGE	SECTION
2 S	5 W	

LIBERTY/WAKULLA COUNTIES		
TOWNSHIP	RANGE	SECTION
5 S	5 W	
5 S	4 W	
3 S	4 W	
4 S	4 W	
5 S	3 W	

WAKULLA/JEFFERSON COUNTIES		
TOWNSHIP	RANGE	SECTION
3 S	1 E	

WALTON/HOLMES COUNTIES		
TOWNSHIP	RANGE	SECTION
4 N	18 W	
5 N	18 W	
6 N	18 W	

WALTON/WASHINGTON COUNTIES		
TOWNSHIP	RANGE	SECTION
3 N	16 W	

ST JOHNS RIVER WATER MANAGEMENT DISTRICT

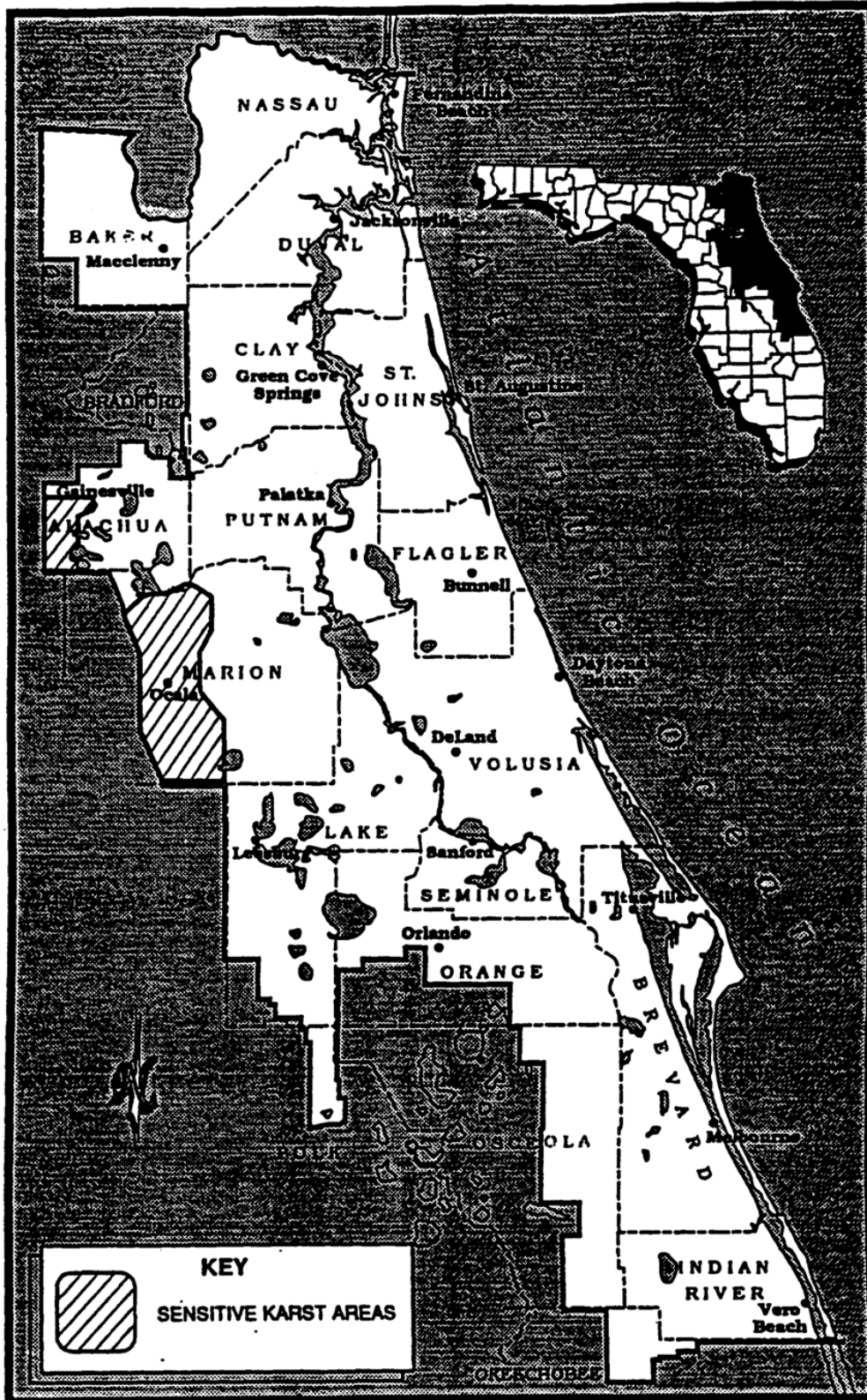

# ALACHUA COUNTY KARST AREA

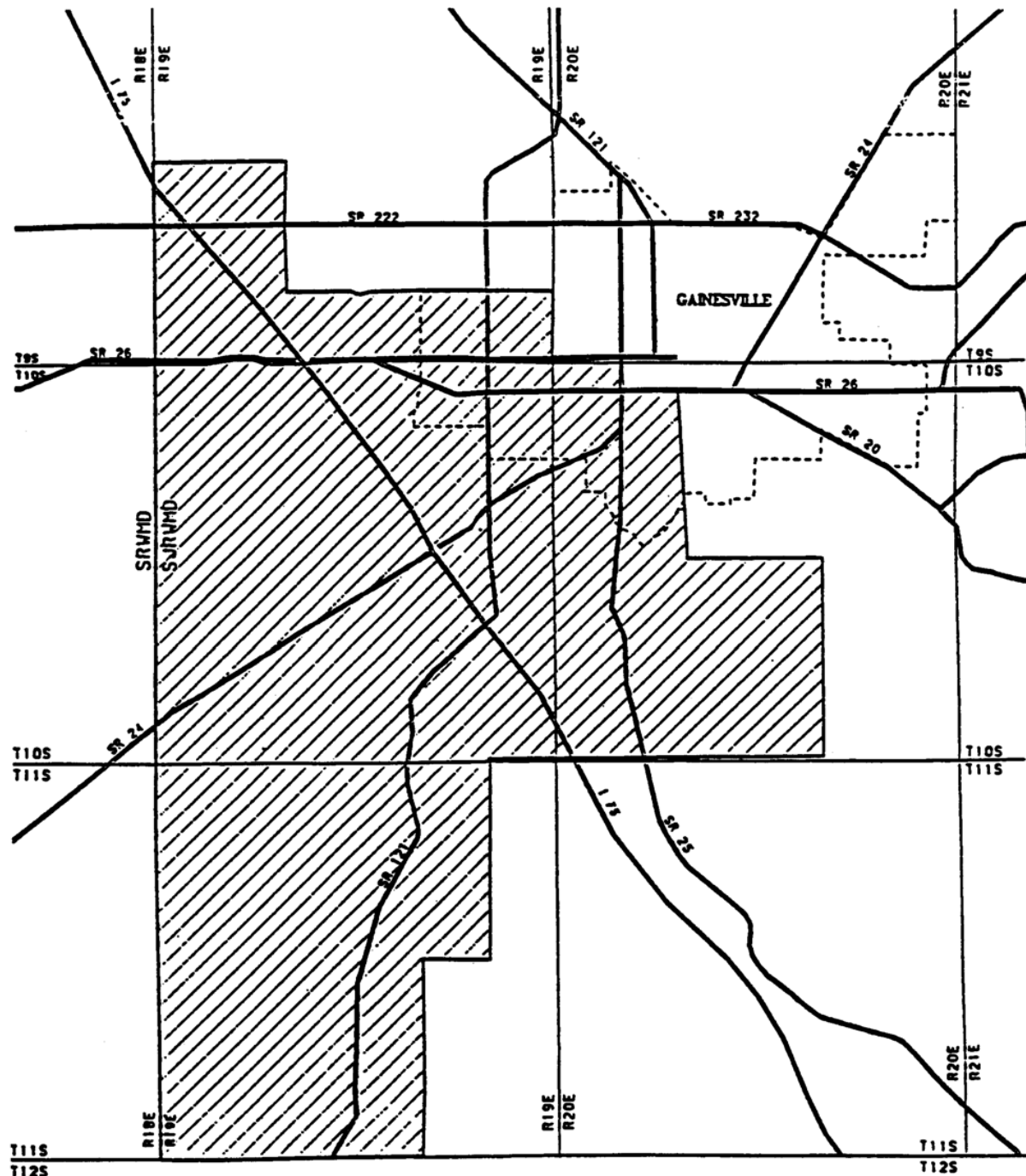

# MARION COUNTY KARST AREA

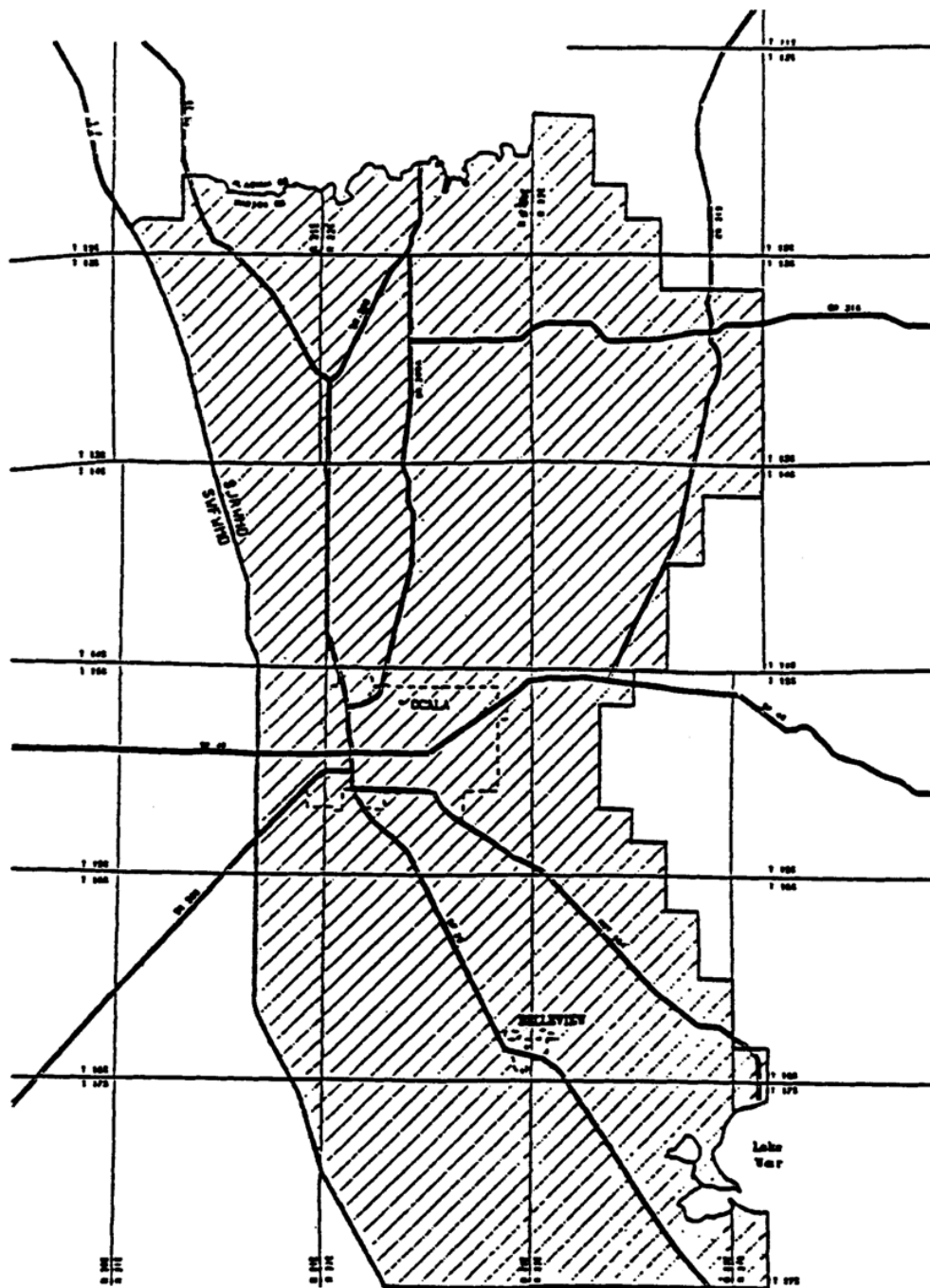

☐ LIMESTONE IS WITHIN 20 FEET OF LAND SURFACE. THE AREA IS A MAJOR RECHARGE AREA FOR THE FLORIDAN AQUIFER.

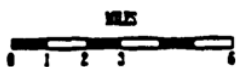



## LEGAL DESCRIPTION

### MARION COUNTY KARST AREA

BEGIN at the intersection of the westerly right-of-way line of Interstate Highway 75 with the Sumter-Marion County line; thence northerly along the westerly right-of-way line of Interstate Highway 75 to the intersection of said westerly right-of-way line with the northerly right-of-way line of State Road 318; thence northeasterly and easterly along the northerly right-of-way line of State Road 318 to the intersection of said right-of-way line with the westerly line of Section 28, Township 12 South, Range 21 East; thence north along the section line to the northwest corner of Section 28, Township 12 South, Range 21 East; thence east along the section line to the Alachua-Marion County line; thence easterly along the Alachua-Marion County line (following the meanderings thereof) to the range line between Range 22 and Range 23 East, the same being the Alachua-Marion County line; thence north along the Alachua-Marion County line and the range line between Range 22 and Range 23 East to the northwest corner of Section 18, Township 12 South, Range 23 East; thence east along the section line to the northeast corner of Section 18, Township 12 South, Range 23 East; thence south along the section lines to the southwest corner of Section 20, Township 12 South, Range 23 East; thence east along the section line to the southeast corner of Section 20, Township 12 South, Range 23 East; thence south along the section line to the northwest corner of Section 33, Township 12 South, Range 23 East; thence east along the section line to the northeast corner of Section 33, Township 12 South, Range 23 East, thence south along the section lines to the southwest corner of Section 3, Township 13 South, Range 23 East; thence east along the section lines to the southeast corner of Section 1, Township 13 South, Range 23 East; thence south along the range line between Range 23 and Range 24 East to the southeast corner of Section 1, Township 14 South, Range 23 East; thence west along the section line to the southeast corner of Section 2, Township 14 South, Range 23 East; thence south along the section lines to the southeast corner of Section 14, Township 14 South, Range 23 East; thence west along the section line to the southwest corner of Section 14, Township 14 South, Range 23 East; thence south along the section lines to the southeast corner of Section 34, Township line between Townships 14 and 15 South to the northeast corner of Section 4, Township 15 South, Range 23 East; thence south along the section line to the southeast corner of Section 4, Township 15 South, Range 23 East; thence west along the section line to the southwest corner of Section 4, Township 15 South, Range 23 East; thence south along the section lines to the southwest corner of Section 21, Township 15 South, Range 23 East; thence east along the section line to the southeast corner of Section 21, Township 15 South, Range 23 East; thence south along the section line to the northwest corner of Section 34, Township 15 South, Range 23 East; thence east along the section line to the northeast corner of Section 34, Township 15 South, Range 23 East; thence south along the section lines to the northwest corner of Section 11, Township 16 South, Range 23 East; thence east along the section line to the northeast corner of Section 11, Township 16 South, Range 23 East; thence south along the section lines to the northwest corner of Section 24, Township 16 South, Range 23 East; thence east along the section line to the northeast corner of Section 24, Township 16 South, Range 23 East; thence south along the range line between Range 23 and Range 24 East to the northwest corner of Section 31, Township 16 South, Range 24 East; thence east along the section line to the northeast corner of Section 31, Township 16 South, Range 24 East; thence south along the section lines to the intersection of the division line between Sections 5 and 6, Township 17 South, Range 24 East with the waters of Lake Weir; thence south crossing the water of Lake Weir to the intersection of the division line between Sections 19 and 20, Township 17 South, Range 24 East with the waters of Lake Weir; thence south along the section lines to the southeast corner of Section 31, Township 17 South, Range 24 East, and the Marion-Lake County line, also being the township line between Townships 17 and 18 South; thence west along the Marion-Lake County line and west along the Sumter-Marion County line, also being the township line between Townships 17 and 18 South, to the POINT OF BEGINNING.

NOTE: This description is based on U.S. Geological Survey 7.5 minute series quadrangle maps and Florida Department of Transportation County Maps.

## LEGAL DESCRIPTION

### ALACHUA COUNTY KARST AREA

BEGIN at the southeast corner of Section 36, Township 11 South, Range 18 East on the Alachua-Levy County line; thence north along the range line between Range 18 and Range 19 East to the northwest corner of Section 19, Township 9 South, Range 19 East; thence east along the section lines to the northeast corner of Section 20, Township 9 South, Range 19 East; thence south along the section lines to the southeast corner of Section 29, Township 9 South, Range 19 East; thence east along the section lines to the northeast corner of Section 36, Township 9 South, Range 19 East; thence south along the range line between Range 19 and Range 20 East to the southeast corner of Section 36, Township 9 South, Range 19 East; thence east along the township line between Township 9 and Township 10 South to the intersection of said township line with the easterly right-of-way line of State Road No. 25 (U.S. Route No. 441); thence south along the easterly right-of-way line of State Road No. 25 (U.S. Route No. 441) to the intersection of said easterly right-of-way line with the northerly right-of-way line of State Road No. 26; thence east along said northerly right-of-way line to the intersection of said northerly right-of-way line with the division line between Section 4 and Section 5, Township 10 South, Range 20 East; thence south along the section lines to the southwest corner of Section 9, Township 10 South, Range 20 East; thence south to the northwest corner of Section 21 Township 10 South, Range 20 East; thence east along the section lines to the northeast corner of Section 22, Township 10 South, Range 20 East; thence south along the section lines and along a southerly prolongation of the east line of Section 27, Township 10 South, Range 20 East, to the intersection of said southerly prolongation with an easterly prolongation of the north line of Section 6, Township 11 South, Range 20 East; thence west along said easterly prolongation to the northeast corner of Section 6, Township 11 South, Range 20 East; thence west along the township line between Township 10 and Township 11 South, to the northwest corner of Section 1, Township 11 South, Range 19 East; thence south along the section lines to the southeast corner of Section 14, Township 11 South, Range 19 East; thence west along the section line to the southwest corner of Section 14, Township 11 South, Range 19 East; thence south along the section lines to the southeast corner of Section 34, Township 11 South, Range 19 East, and the Alachua Marion County line, also being the township line between Township 11 and Township 12 South; thence west along the Alachua-Marion County line and west along the Alachua-Levy County line to the POINT OF BEGINNING.

NOTE: This description is based on U.S. Geological Survey 7.5 minute series Quadrangle maps and Florida Department of Transportation County Maps.

## **APPENDIX H INSPECTION CHECKLIST FORMS**

The inspection checklist forms included in this Appendix may be used for completing inspection during and after construction or they be used as a model by Inspectors and Registered Professionals who wish to create their own equivalent forms.

### Construction Inspection Forms

- Retention Basins
- Infiltration/Exfiltration Trenches
- Swales
- Pervious Pavements

### Operation and Maintenance Inspection Forms

- Retention Basins
- Infiltration/Exfiltration Trenches
- Swales
- Pervious Pavements

**NOTE: THIS APPENDIX WILL NOT BE ADOPTED IN THE STORMWATER RULE**

# Infiltration Basin Construction Inspection Report Form

Date \_\_\_\_\_ Time \_\_\_\_\_

Project \_\_\_\_\_

Location \_\_\_\_\_

Individual Contacted \_\_\_\_\_

Site Status \_\_\_\_\_ (active, inactive, completed)

	Satisfactory	Unsatisfactory
<b>1. Pre-construction</b>		
Runoff diverted	_____	_____
Area stabilized	_____	_____
<b>2. Excavation</b>		
Size and location	_____	_____
Side slope stable	_____	_____
Soil Permeability	_____	_____
Ground water/Limerock	_____	_____
<b>3. Embankment</b>		
Cut-off trench	_____	_____
Fill material compaction	_____	_____
<b>4. Final Excavation</b>		
Drainage area stabilized	_____	_____
Sediment removed from facility	_____	_____
Excavated to final design elevations	_____	_____
Basin floor tilled	_____	_____
Facility stabilized	_____	_____
<b>5. Final Inspection</b>		
Pretreatment facility in place	_____	_____
Inlets/outlets	_____	_____
Site stabilization	_____	_____
Access to facility provided	_____	_____

Action to be taken:

No action necessary. Continue routine inspections \_\_\_\_\_

Correct noted site deficiencies by \_\_\_\_\_

1st notice \_\_\_\_\_

2nd notice \_\_\_\_\_

Submit plan modifications as noted in written comments by \_\_\_\_\_

Notice to Comply issued \_\_\_\_\_

Final inspection, project completed \_\_\_\_\_

# Infiltration/Exfiltration Trench Construction Inspection Report Form

Date \_\_\_\_\_ Time \_\_\_\_\_

Project \_\_\_\_\_

Location \_\_\_\_\_

Individual Contacted \_\_\_\_\_

Site Status \_\_\_\_\_ (active, inactive, completed)

1. Pre-construction	Satisfactory	Unsatisfactory
---------------------	--------------	----------------

Runoff diverted	_____	_____
Area stabilized	_____	_____

2. Excavation

Size and location	_____	_____
Side slope stable	_____	_____
Soil Permeability	_____	_____
Ground water/Limerock	_____	_____

3. Filter Fabric Placement

Fabric specification	_____	_____
Placed on bottom, sides, and top	_____	_____

4. Aggregate Material

Size as specified	_____	_____
Clean/washed material	_____	_____
Placed properly	_____	_____

5. Observation Well

Pipe size	_____	_____
Removable cap/footplate	_____	_____
Initial depth = _____ ft.	_____	_____

6. Final Inspection

Pretreatment facility in place	_____	_____
Stabilization	_____	_____
Outlet	_____	_____

Action to be taken:

No action necessary. Continue routine inspections \_\_\_\_\_

Correct noted site deficiencies by \_\_\_\_\_

1st notice \_\_\_\_\_

2nd notice \_\_\_\_\_

Submit plan modifications as noted in written comments by \_\_\_\_\_

Notice to Comply issued \_\_\_\_\_

Final inspection, project completed \_\_\_\_\_



# Pervious Pavement Construction Inspection Report Form

Date \_\_\_\_\_ Time \_\_\_\_\_

Project \_\_\_\_\_

Location \_\_\_\_\_

Individual Contacted \_\_\_\_\_

Site Status \_\_\_\_\_ (active, inactive, completed)

	Satisfactory	Unsatisfactory
1. Pre-construction		
Runoff diverted	_____	_____
Area stabilized	_____	_____
2. Excavation		
Size and location	_____	_____
Side slope stable	_____	_____
Soil Permeability	_____	_____
Ground water/Limerock	_____	_____
3. Filter Fabric Placement		
Fabric specification	_____	_____
Placed on bottom, sides, and top	_____	_____
4. Aggregate Base Course		
Size as specified	_____	_____
Clean/washed material	_____	_____
Placed properly	_____	_____
5. Aggregate Filter Course		
Size	_____	_____
Clean/washed material	_____	_____
Placed Properly	_____	_____
6. Porous Surface Course		
Proper temperature/compaction	_____	_____
7. Final Inspection		
Smooth Surface & Transition	_____	_____
Test section	_____	_____
ERIK device installed	_____	_____
Final stabilization	_____	_____

Action to be taken:

- No action necessary. Continue routine inspections \_\_\_\_\_
- Correct noted site deficiencies by \_\_\_\_\_
  - 1st notice \_\_\_\_\_
  - 2nd notice \_\_\_\_\_
- Submit plan modifications as noted in written comments by \_\_\_\_\_
- Notice to Comply issued \_\_\_\_\_
- Final inspection, project completed \_\_\_\_\_

# Infiltration Swale Construction Inspection Report Form

Date \_\_\_\_\_ Time \_\_\_\_\_

Project \_\_\_\_\_

Location \_\_\_\_\_

Individual Contacted \_\_\_\_\_

Site Status \_\_\_\_\_ (active, inactive, completed)

	Satisfactory	Unsatisfactory
<b>1. Pre-construction</b>		
Runoff diverted	_____	_____
Area stabilized	_____	_____
<b>2. Excavation</b>		
Size and location	_____	_____
Side slope stable	_____	_____
Soil Permeability	_____	_____
Ground water/Limerock	_____	_____
<b>3. Swale Blocks/Raised culverts</b>		
Elevations	_____	_____
Dimensions	_____	_____
Compaction	_____	_____
Stability	_____	_____
<b>4. Final Inspection</b>		
Elevations	_____	_____
Dimensions	_____	_____
Swale blocks/raised culverts	_____	_____
Proper outlet	_____	_____
Effective stabilization	_____	_____

**Action to be taken:**

No action necessary. Continue routine inspections \_\_\_\_\_

Correct noted site deficiencies by \_\_\_\_\_

1st notice \_\_\_\_\_

2nd notice \_\_\_\_\_

Submit plan modifications as noted in written comments by \_\_\_\_\_

Notice to Comply issued \_\_\_\_\_

Final inspection, project completed \_\_\_\_\_

# Infiltration Basin Maintenance Inspection Report Form

Date \_\_\_\_\_ Time \_\_\_\_\_

Project \_\_\_\_\_

Location \_\_\_\_\_

Individual Conducting the Inspection \_\_\_\_\_ "As Built" Plans available Y/N

	Satisfactory	Unsatisfactory
1. Debris cleanout (Monthly)		
Basin bottom clear of debris	_____	_____
Inlet clear of debris	_____	_____
Outlet clear of debris	_____	_____
Emergency spillway clear of debris	_____	_____
2. Sediment traps or forebays (Annual)		
Obviously trapping sediment	_____	_____
Greater than 50% of storage volume remaining	_____	_____
3. Vegetation (Monthly)		
Mowing done when needed	_____	_____
Fertilized per specifications	_____	_____
Evidence of cattails	_____	_____
No evidence of erosion	_____	_____
4. Dewatering (Monthly)		
Basin dewateres between storms	_____	_____
Ponded water evidence	_____	_____
Deep tilling needed	_____	_____
5. Sediment cleanout of basin (Annual)		
No evidence of sedimentation in basin	_____	_____
Sediment accumulation does not yet require cleanout	_____	_____
6. Inlets (Annual)		
Good condition	_____	_____
No evidence of erosion	_____	_____
7. Outlets/overflow spillway (Annual, After Major Storm)		
Good condition, no need for repair	_____	_____
No evidence of erosion	_____	_____



# Infiltration Trench Maintenance Inspection Report Form

Date \_\_\_\_\_ Time \_\_\_\_\_

Project \_\_\_\_\_

Location \_\_\_\_\_

Individual Conducting the Inspection \_\_\_\_\_ "As Built" Plans available Y/N

*Inspection frequency shown in parentheses after item being considered*

	Satisfactory	Unsatisfactory
1. Debris cleanout (Monthly)		
Trench surface clear of debris	_____	_____
Inlet areas clear of debris	_____	_____
Inflow pipes clear of debris	_____	_____
Overflow spillway clear of debris	_____	_____
2. Sediment traps, forebays, or pretreatment swales (Annual)		
Obviously trapping sediment	_____	_____
Greater than 50% of storage volume remaining	_____	_____
3. Vegetation (Monthly)		
Mowing done when needed	_____	_____
Fertilized per specifications	_____	_____
Cattails present	_____	_____
No evidence of erosion	_____	_____
4. Dewatering (Monthly)		
Trench dewatered between storms	_____	_____
Ponded water evidence	_____	_____
5. Sediment cleanout of trench (Annual)		
No evidence of sedimentation in trench	_____	_____
Sediment accumulation does not yet require cleanout	_____	_____
6. Inlets (Annual)		
Good condition	_____	_____
No evidence of erosion	_____	_____
7. Outlets/overflow spillway (Annual)		
Good condition, no need for repair	_____	_____
No evidence of erosion	_____	_____



Satisfactory   Unsatisfactory

8. Aggregate repairs (Annual)

Surface of aggregate clean	_____	_____
Top layer of stone does not need replacement	_____	_____
Trench does not need rehabilitation	_____	_____

9. Vegetated surface (Monthly)

No evidence of erosion	_____	_____
Perforated inlet functioning adequately	_____	_____
Water does not stand on vegetative surface	_____	_____
Good vegetative cover exists	_____	_____

Action to be taken: If any of the answers to the above items are checked unsatisfactory, a time frame shall be established for their correction or repair

No action necessary.

Continue routine inspections \_\_\_\_\_

Correct noted facility deficiencies by

\_\_\_\_\_

\_\_\_\_\_

\_\_\_\_\_

\_\_\_\_\_

Facility repairs were indicated and completed. Site reinspection is necessary to verify corrections or improvements.

Site reinspection accomplished on \_\_\_\_\_

Site reinspection was satisfactory. \_\_\_\_\_

Next routine inspection is scheduled for approximately: \_\_\_\_\_

Signature of Inspector \_\_\_\_\_



Facility repairs were indicated and completed. Site reinspection is necessary to verify corrections or improvements.

Site reinspection accomplished on \_\_\_\_\_

Site reinspection was satisfactory.

Next routine inspection is scheduled for approximately: \_\_\_\_\_

Signature of Inspector \_\_\_\_\_

Infiltration Swale Maintenance Inspection Report Form

Date \_\_\_\_\_ Time \_\_\_\_\_

Project \_\_\_\_\_

Location \_\_\_\_\_

Individual Conducting the Inspection \_\_\_\_\_ "As Built" Plans available Y/N

	<u>Satisfactory</u>	<u>Unsatisfactory</u>
1. Debris cleanout (Monthly)		
Swales and contributing areas clean of debris	_____	_____
2. Vegetation (Monthly)		
Mowing done when needed	_____	_____
Fertilized per specifications	_____	_____
No evidence of erosion	_____	_____
Minimum mowing depth not exceeded	_____	_____
3. Dewatering (Monthly)		
Swale dewateres between storms	_____	_____
4. Swale blocks/raised culverts, energy disappators		
No evidence of flow going around structure	_____	_____
No evidence of erosion at downstream toe	_____	_____
5. Sediment deposition (Annual)		
Swale clean of sediments	_____	_____
6. Outlets/overflow spillway		
Good condition, no need for repair	_____	_____
No evidence of erosion	_____	_____

Action to be taken:

If any of the answers to the above items are checked unsatisfactory, a time frame shall be established for their correction or repair

No action necessary.

Continue routine inspections \_\_\_\_\_

Correct noted facility deficiencies by \_\_\_\_\_

Facility repairs were indicated and completed. Site reinspection is necessary to verify corrections. Site reinspection accomplished on \_\_\_\_\_

Site reinspection was satisfactory.

Next routine inspection is scheduled for approximately: \_\_\_\_\_

Signature of Inspector \_\_\_\_\_

**APPENDIX I**

**REFERENCES AND OTHER EDUCATIONAL MATERIALS  
TO ASSIST USERS IN DESIGNING BETTER  
STORMWATER TREATMENT SYSTEMS**

**NOTE: THIS APPENDIX WILL NOT BE ADOPTED IN THE STORMWATER RULE**



The following references are provided for those who wish to obtain additional information about the effective design, construction, operation, and maintenance of stormwater treatment systems.

### **Chapter 1. Applicability**

The Laws and Rules of regulated professions in Florida can be accessed at the following web addresses:

Florida Statutes:

[http://www.leg.state.fl.us/STATUTES/index.cfm?App\\_mode=Display\\_Index&Title\\_Request=XXXII#TitleXXXII](http://www.leg.state.fl.us/STATUTES/index.cfm?App_mode=Display_Index&Title_Request=XXXII#TitleXXXII)

Rules (Florida Administrative Code):

<https://www.flrules.org/Default.asp>

### **Chapter 3. Performance standards and methodology**

Verified lists of impaired waters are available at:

<http://www.dep.state.fl.us/water/watersheds/assessment/index.htm>. Water bodies with adopted TMDLs are listed in Chapter 62-304, F.A.C. while adopted BMAPs are at:  
<http://www.dep.state.fl.us/water/watersheds/bmap.htm>.

Much of the data used in the stormwater treatment rule (i.e., rainfall, stormwater EMCs, BMP efficiency, etc) have been compiled in the following report done under contract for DEP:

Harper, H.H. and David M. Baker. (2007). "Evaluation of Current Stormwater Design Criteria within the State of Florida". Final report submitted to Florida Department of Environmental Protection, Tallahassee, Fl. under Agreement S0108. This report can be downloaded from:  
[http://www.dep.state.fl.us/water/nonpoint/pubs.htm#Urban\\_Stormwater\\_BMP\\_Research\\_Reports](http://www.dep.state.fl.us/water/nonpoint/pubs.htm#Urban_Stormwater_BMP_Research_Reports)

Soil Surveys and Official Soil Series Descriptions are available through the NRCS Web Soil Survey which is accessible at: <http://websoilsurvey.nrcs.usda.gov/app/HomePage.htm>

### **Chapter 4. Erosion and Sediment Control**

The NPDES stormwater construction generic permit which is required on all sites that disturb one or more acre of land is available at: <http://dep.state.fl.us/water/stormwater/npdes/docs/cgp.pdf>

The Florida Erosion and Sediment Control Designers and Reviewer Manual is available at: [http://stormwater.ucf.edu/FLerosionSedimentManual\\_6\\_07.pdf](http://stormwater.ucf.edu/FLerosionSedimentManual_6_07.pdf)

### **Part V BMPs**

DEP's guidance on the requirements for testing and disposal of sediments removed from stormwater systems can be accessed at:

<http://www.dep.state.fl.us/water/nonpoint/docs/nonpoint/May04StSweepGuidance.pdf>

## Chapter 7. Exfiltration Trenches

Additional information regarding design references and analysis of exfiltration systems can be found in the following FDOT publications:

- Section 5.3.4.3 *Exfiltration Trenches* of the January 2009 edition of the *Drainage Manual*, available at: <http://www.dot.state.fl.us/rddesign/dr/Manualsandhandbooks.shtm>
- *Exfiltration System Handbook*, January, 2007, available at: <http://www.dot.state.fl.us/rddesign/dr/Manualsandhandbooks.shtm>

Additional graphic details of exfiltration trench systems are available on FDOT's [Roadway Standard](#) Index Drawings #285 (two sheets) and #241 (one sheet), available at:

<http://www.dot.state.fl.us/rddesign/DesignStandards/Standards.shtm>  
<http://www.dot.state.fl.us/rddesign/rd/rtds/08/2008Standards.shtm>

Additional research information regarding underground exfiltration trench systems can be found in a 1990 Masters thesis entitled *Evaluation of Exfiltration Systems* by David L. Evans, available at the following web address at the UCF Stormwater Management Academy:

[http://stormwater.ucf.edu/research/FILES/exfiltration\\_designs09\\_1990.pdf](http://stormwater.ucf.edu/research/FILES/exfiltration_designs09_1990.pdf)

## Chapter 8. Underground retention vaults and chambers

### Confined Spaces

The working environment within the underground system is characterized as a “confined space” and worker safety must be addressed. The appropriate Federal Occupational Safety and Health Administration (OSHA) requirements will need to be met during any activities where personnel are required to enter the underground system. At all points of entry into the underground system, warning signage shall be posted to ensure that individuals do not enter until the requisite safeguards have been put in place. Additional information regarding confined space issues can be found at the following web sites:

[http://www.osha.gov/pls/oshaweb/owadisp.show\\_document?p\\_table=standards&p\\_id=9797](http://www.osha.gov/pls/oshaweb/owadisp.show_document?p_table=standards&p_id=9797)  
[http://www.osha.gov/pls/oshaweb/owadisp.show\\_document?p\\_id=9801&p\\_table=STANDARDS](http://www.osha.gov/pls/oshaweb/owadisp.show_document?p_id=9801&p_table=STANDARDS)  
<http://www.osha-safety-training.net/CFS/confined.html>  
<http://www.thefreelibrary.com/Confined+space+regulations+born+from+industry-a0153292457>

## Chapter 9. Swales

Avellaneda, Eduardo. 1985. *Infiltration Through Roadside Swales*. M.S. Thesis, University of Central Florida, College of Engineering. Available at <http://stormwater.ucf.edu>

## Chapter 11 Pervious Pavements

For additional information on ERIKs and in-situ infiltration monitors, refer to the following UCF research paper: “Construction and Maintenance Assessment of Pervious Concrete Pavements,” 2007 at <http://stormwater.ucf.edu/researchpublications.asp>

(s) Storage (S) for the required treatment volume (RTV) within the pervious pavement system can be estimated using the Pervious Pavement “Design Aid” (in Excel® format), available at:

<http://stormwater.ucf.edu/>. If applicable, this Excel® spreadsheet can also estimate reduced Curve Numbers (CNs) and Rational “C” values based on a particular design storm depth of interest. Typically, pervious pavement systems are considered as retention systems for storing and recovering the required treatment volume (without down-gradient surface water discharge and minimal down-gradient ground water discharge). Therefore, runoff CNs and Rational “C” values are not applicable for the required treatment volume storage computations and the subsequent recovery/mounding analysis.

There may be infrequent situations where the ERP applicant (and their engineering consultant) wishes to detain all of the **Required Attenuation Volume** (RAV) in the proposed pervious pavement system. These infrequent situations may occur where a project is located in excessively drained HSG “A” soils (with a deep SHGWT and confining unit), or where the engineering consultant proposes a thicker underlying storage reservoir (using pea rock, #57 stone, etc.) over imported (hydraulically clean) soils. ERP applicants (and their engineering consultants) should consult with the appropriate regulatory agencies (for additional requirements or prohibition) in taking required treatment volume credit as part of the RAV.

If allowed by the appropriate regulatory agencies, reduced runoff CNs and Rational “C” values (for pervious pavement systems) can be used for their share of the contributing watershed that discharges down-gradient to a flood control detention system.

Sustainable void spaces shall be used for all RTV and RAV storage computations (including the stage/storage input for the recovery/mounding analysis). This information can be found on the Graphical Results tab of the Pervious Pavement “Design Aid” (in Excel® format), available at: <http://stormwater.ucf.edu/>.

## Chapter 12. Greenroof/cistern systems

1. Hardin, M. (2006). “The effectiveness of A Specifically Designed Green Roof Stormwater Treatment System Irrigated with Recycled Stormwater Runoff to Achieve Pollutant Removal and Stormwater Volume Reduction”, M.S. Thesis, University of Central Florida, Orlando Florida. And from the Florida Department of Environmental Protection, The Effectiveness of Green Roof Stormwater Treatment Systems Irrigated with Recycled Green Roof Filtrate to Achieve Pollutant Removal with Peak and Volume Reduction in Florida (Final Report - Adobe PDF Document - 779 KB).
2. Wanielista, M.P., and M. Hardin. (2007). “Designing Green Roofs in Florida”. 9<sup>th</sup> Biennial Conference on Stormwater Research and Watershed Management, Orlando. And from the Florida Department of Environmental Protection, Stormwater Effectiveness of an Operating Green Roof Stormwater Treatment System and Comparison to Scaled Down Green Roof Stormwater Treatment System Chambers (Final Report - Adobe PDF Document -1 MB).
3. Wanielista, M.P., and M. Hardin. (2006). “A Stormwater Management Assessment of Green Roofs with Irrigation”. 2<sup>nd</sup> Stormwater Management Research Symposium. Orlando, FL.

**Chapter 13. Wet detention systems**  
**Flow Paths**

Inlet to outlet ratio of 0.80 or greater calculated by using:

**Equation 13-2** Flow Path Ratio (FPR) =  $\text{SUM} ((A/LP)_i * V_i)$

Where:  $A_i$  = actual travel distance for inflow  $i$

$LP_i$  = longest possible travel distance for inflow  $i$

$V_i$  = fraction of annual runoff volume contributed by inflow  $i$

Not same equation as in powerpoint figures below

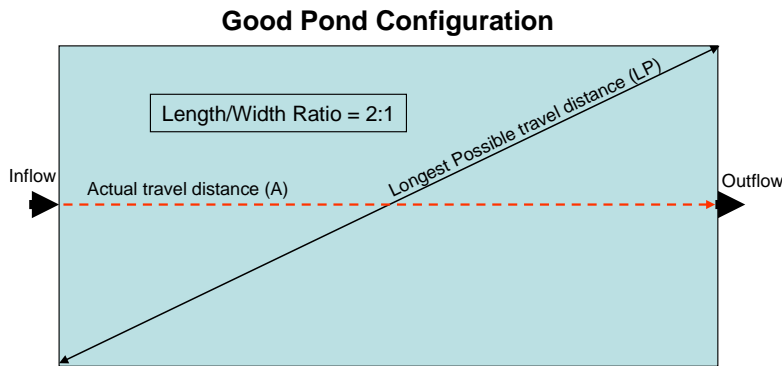

Flow Path Ratio (FPR) =  $A/LP$   
 FPR for Fig. a =  $2/\sqrt{(2^2+1^2)} = 0.89$

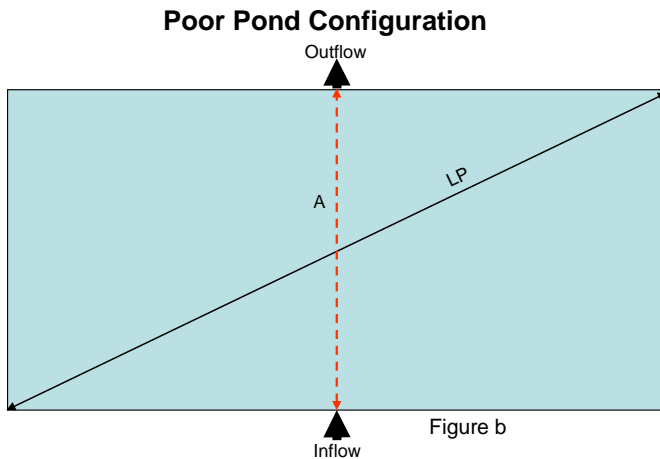

FPR for Fig. b =  $1/\sqrt{(2^2+1^2)} = 0.45$

For multiple inflows, calculate FPR based on weighted average

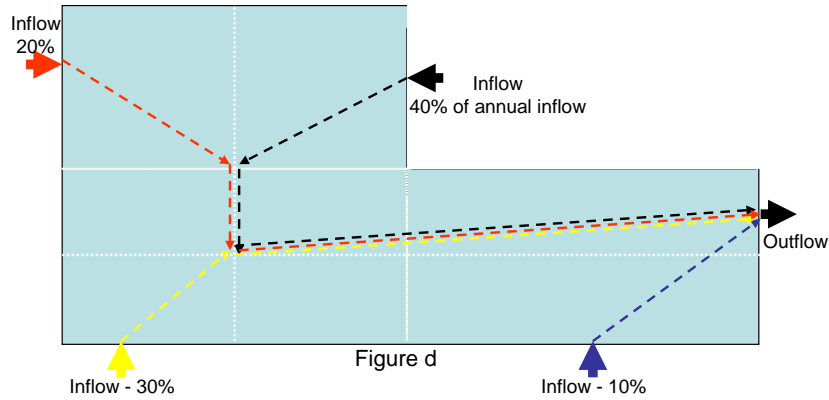

$$\text{FPR} = [(4.3 \cdot 0.2) + (4.55 \cdot 0.4) + (3.8 \cdot 0.3) + (1.3 \cdot 0.1)] / 4.8$$

$$= 3.95 / 4.8 = \mathbf{0.82 \text{ (good pond design)}}$$

If the largest and smallest inflows are switched

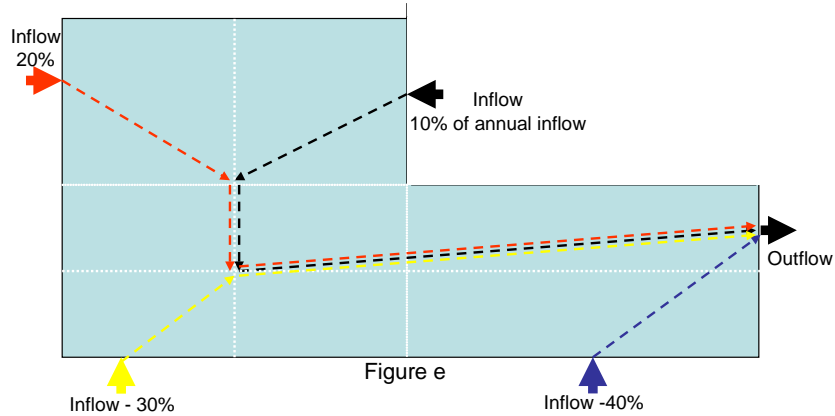

$$\text{FPR} = [(4.3 \cdot 0.2) + (4.55 \cdot 0.1) + (3.8 \cdot 0.3) + (1.3 \cdot 0.4)] / 4.8$$

$$= 2.98 / 4.8 = \mathbf{0.62 \text{ (poor pond design)}}$$



## Chapter 21. Soil testing and SHGWT

Additional information on ARC can be found in the following Federal publication of the Natural Resources Conservation Service (NRCS):

Part 630, Hydrology, National Engineering Handbook, Chapter 10 – *Estimation of Direct Runoff from Storm Rainfall*, available at: <http://directives.sc.egov.usda.gov/viewerFS.aspx?hid=21422>

**Reference: SJRWMD special publication SJ93-SP10, page 169.** The web address for this special publication is noted in a subsequent paragraph of this section.

### C. Soil storage for retention BMPs placed over excessively drained soils

**Source:** Equation 4-4 of the 1989/1991 Jammal & Associates, Inc. report entitled *Stormwater Retention Pond Infiltration Analysis in Unconfined Aquifers*, prepared for the Southwest Florida Water Management District. The web address for this special publication is noted in a subsequent section of this Handbook.

Additional information on excessively drained soils (and other *Natural Drainage Class* definitions) can be found in Chapter 3 of the following Federal publication of the Natural Resources Conservation Service (NRCS):

The October, 1993 Soil Survey Manual, available at:

<http://soils.usda.gov/technical/manual/>

[http://soils.usda.gov/technical/manual/print\\_version/chapter3.html#27](http://soils.usda.gov/technical/manual/print_version/chapter3.html#27)

Additional information on Hydrologic Soil Groups (HSGs) can be found in the following Federal publication of the Natural Resources Conservation Service (NRCS):

Part 630, Hydrology, National Engineering Handbook, Chapter 7 – *Hydrologic Soil Groups*, available at: <http://directives.sc.egov.usda.gov/viewerFS.aspx?hid=21422>

### Definition of SPT “N” Values

The Standard Penetration Test (SPT) consists of driving a split-barrel sampling "spoon" or sampler a distance of 30 cm (12 in) after first "seating" the sampler 15 cm (6 in) by dropping a 63.5 kg (140 lb) hammer from a height of 76 cm (30 in). In field practice, the sampler is driven to a designated depth through a borehole using a long rod, and the hammer strikes the top end of the rod above the ground surface. The operator counts the number of blows that it takes to advance the sampler each of three 15 cm (6 in) increments. When the sampler has penetrated 45 cm (18 in) into the soil at the bottom of the borehole, the operator adds the number of blows for the second and third increments. This combined number is the result of the SPT and is called the "**blow count**" and is customarily designated as "**N**" or the "**N value**". **It directly reflects the penetration resistance of the ground or the soil under investigation.**

**Source:** US Patent 6286613 - Impact method and the device used in standard penetration test  
<http://www.patentstorm.us/patents/6286613/description.html>

Additional information on defining the “bottom of aquifer parameter” was summarized in a 06/23/06 e-Mail to the SJRWMD by Devo Seereeram, P.E., Ph.D. This document is available at the following web address:

[http://devoeng.com/memos/recommended\\_procedure\\_for\\_selecting\\_base\\_of\\_aquifer.pdf](http://devoeng.com/memos/recommended_procedure_for_selecting_base_of_aquifer.pdf)



### Definition of a Hardpan

A hardpan is a hardened or cemented soil horizon or layer. The soil material is sandy, loamy, or clayey and is cemented by iron oxide, silica, calcium carbonate or other substances.

**Source:** SJRWMD: Special Publication SJ93-SP10 (page 24)

### Definition of a Spodic Horizon

Florida's pine Flatwoods areas typically have a spodic horizon into which organic matter has accumulated. In many cases, this spodic horizon is locally called a hardpan. Pine Flatwoods are the most predominant natural landscape in Florida, comprising approximately 8.4 million acres.

**Source:** SJRWMD: Special Publication SJ93-SP10 (page 24), and the annual NRCS/SWFWMD Soils and SHGWT public workshop presentations.

### **G. Estimated Normal Seasonal High Ground water Table (SHGWT)**

**Reference:** SJRWMD's Special Publication SJ93-SP10 (pages #162 - #163)

Additional resources related to estimating the depth to the normal SHGWT are provided below:

- *Estimating the Normal Seasonal High Ground water Table: A Mix of Art & Science*, April, 1993, by Devo Seereeram, Ph.D., P.E., available at:  
[http://www.devoeng.com/memos/paper\\_on\\_estimating\\_SHWT.pdf](http://www.devoeng.com/memos/paper_on_estimating_SHWT.pdf)
- *Determination of Seasonal High Water Table (SHWT) from the "Surface Water Management Design Aids"* section of the SFWMD's 2008 ERP Information Manual, Volume IV available at:  
[http://my.sfwmd.gov/pls/portal/docs/PAGE/PG\\_GRP\\_SFWMD\\_ENVIROREG/PORTLET\\_REGUIDANCE/TAB383509/COMPLETE%20VOL\\_IV\\_MARCH\\_22\\_2009%20CHAN\\_GES.PDF](http://my.sfwmd.gov/pls/portal/docs/PAGE/PG_GRP_SFWMD_ENVIROREG/PORTLET_REGUIDANCE/TAB383509/COMPLETE%20VOL_IV_MARCH_22_2009%20CHAN_GES.PDF)
- Annual public workshops (during February and March) on the proper determination of Seasonal High Ground Water Table (SHGWT) Elevations. These workshops are hosted by the Southwest Florida Water Management District (SWFWMD) in cooperation with the federal NRCS.

To be placed on the SWFWMD's mailing list for these workshops, please contact the Strategic Program Office, Resource Regulation Division, at the District's Brooksville headquarters, 800-423-1476 (Florida only) or 352-796-7211. Additional information on these workshops can be accessed in late December/early January at the following web address: <http://www.swfwmd.state.fl.us/calendar/conferences/>

- Seasonal Variability of Near Surface Soil Water and Ground water Tables in Florida, August, 2006. FDOT: BC354RPWO79, UF: 4910-4504-958-12, available at:  
[http://www.dot.state.fl.us/research-center/Completed\\_Proj/Summary\\_RD/FDOT\\_BC354\\_79\\_rpt.pdf](http://www.dot.state.fl.us/research-center/Completed_Proj/Summary_RD/FDOT_BC354_79_rpt.pdf)  
or  
[http://devoeng.com/memos/FDOT\\_BC354\\_79\\_rpt.pdf](http://devoeng.com/memos/FDOT_BC354_79_rpt.pdf)

A general set of guidelines for estimating saturated hydraulic conductivity from field observable characteristics is also presented in Chapter 3 of the 1993 Soil Survey Manual from the

Natural Resources Conservation Service (NRCS), available at:  
<http://soils.usda.gov/technical/manual/>

One of the most important steps in the evaluation of a stormwater BMPs is determining which test methods and how many tests should be conducted per system. Typically, a soil boring and some type of saturated hydraulic conductivity measurement are conducted for each retention BMP. The American Society for Testing and Materials (ASTM) describes the various methodologies that can be used for evaluating soil conditions and saturated hydraulic conductivities. Additional guidance and recommendations can be found in the following publications from the St. Johns River Water Management District (SJRWMD) and the Southwest Florida Water Management District (SWFWMD):

SJRWMD: Special Publication SJ93-SP10, August, 1993 entitled *Full-Scale Hydrologic Monitoring of Stormwater Retention Ponds and Recommended Hydro-Geotechnical Design Methodologies*, available at the following web addresses:  
<http://sjr.state.fl.us/technicalreports/spubs4.html#1993>  
[http://www.dep.state.fl.us/water/wetlands/erp/rules/stormwater/issue\\_lid.htm](http://www.dep.state.fl.us/water/wetlands/erp/rules/stormwater/issue_lid.htm)

SWFWMD: *Stormwater Retention Pond Infiltration Analysis in Unconfined Aquifers*, 1989 and 1991, available at the following web address:  
[http://www.dep.state.fl.us/water/wetlands/erp/rules/stormwater/issue\\_lid.htm](http://www.dep.state.fl.us/water/wetlands/erp/rules/stormwater/issue_lid.htm)

Electric analog studies (Bouwer, 1978, *Ground water Hydrology*, McGraw-Hill Book Company, New York) indicate that the maximum depth of the mobilized aquifer is about equal to the width of the pond for isotropic aquifers. **Based on Bouwer's study, it is recommended that the aquifer thickness used in analysis not be greater than the width of the BMP** (i.e., for a long and narrow swale with swale blocks, the maximum aquifer thickness should be no greater than the swale width). **Source:** SJRWMD's Special Publication SJ93-SP10 (page #162).

For additional guidance on obtaining reasonable saturated horizontal hydraulic conductivity test results for depths greater than five (5) feet BLS, refer to pages 5 and 6 of the previously referenced SJRWMD Special Publication SJ93-SP10.